

KEMET Part Number: SC-02-300
(UALSC023000000)

Choke, SC, 3000 uH

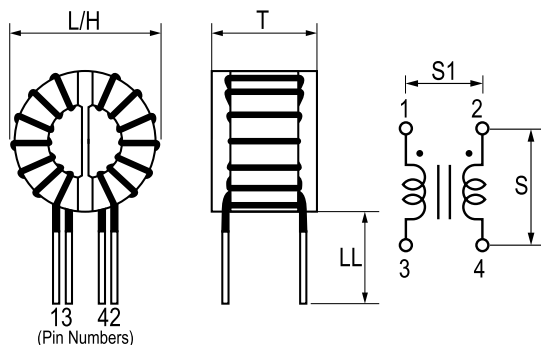

General Information

Style:	Through-Hole Toroid
Series:	SC
Description:	Standard Common Mode Filter
RoHS:	Yes
Miscellaneous:	Inductance Measurement Condition: 100kHz 1mA KC547
Notes:	Lead Spacing (S/S1) Are For Reference Only.

Specifications

Inductance:	3000 uH
Rated Temperature:	105C
Current:	2 Amps
Voltage AC:	250 VAC
DC Resistance:	100 mOhms
Insulation Resistance:	100 MOhms

Dimensions

L	27mm MAX
T	20mm MAX
H	27mm MAX
S	17mm MAX
S1	6mm NOM
LL	15mm +/-2mm
Wire Size	0.6mm

Packaging Specifications

Weight:	16 g
----------------	------