

KEMET Part Number: SC-05-200
(UALSC052000000)

Choke, SC, 2000 uH

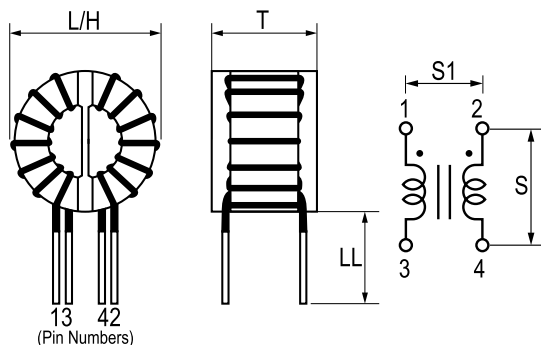

General Information

Style:	Through-Hole Toroid
Series:	SC
Description:	Standard Common Mode Filter
RoHS:	Yes
Miscellaneous:	Inductance Measurement Condition: 100kHz 1mA KC547
Notes:	Lead Spacing (S/S1) Are For Reference Only.

Specifications

Inductance:	2000 uH
Rated Temperature:	105C
Current:	5 Amps
Voltage AC:	250 VAC
DC Resistance:	70 mOhms
Insulation Resistance:	100 MOhms

Dimensions

L	32mm MAX
T	22mm MAX
H	32mm MAX
S	21mm MAX
S1	7mm NOM
LL	15mm +/-2mm
Wire Size	0.8mm

Packaging Specifications

Weight:	25 g
----------------	------