

# T513 Series Commercial Off-The-Shelf (COTS) Multiple Anode Low ESR MnO<sub>2</sub>

## Overview

The KEMET T513 Series is suitable for the Commercial Off-The-Shelf (COTS) requirements of industrial, telecom, defense and aerospace markets. This surface mount series offers very low ESR and surge robustness designed for applications that require high surge current and high

ripple current capability. These benefits are achieved via a multiple anode construction similar to KEMET's T510 Series. The T513 Series COTS also offers various options including Weibull Grading, termination finish and surge current.

## Benefits

- Meets or exceeds EIA Standard 535BAAC
- Taped and reeled per EIA 481
- High surge current capability
- Termination options B, C, H, K, T
- High ripple current capability
- Surge testing options
- 100% steady-state accelerated aging
- Capacitance values of 15  $\mu$ F to 1,000  $\mu$ F
- Tolerances of  $\pm 10\%$  and  $\pm 20\%$
- Voltage rating of 4 – 35 VDC
- Case sizes D, E, and X
- ESR as low as 10 m $\Omega$
- RoHS compliant 100% Sn terminations available
- Operating temperature range of  $-55^{\circ}\text{C}$  to  $+125^{\circ}$

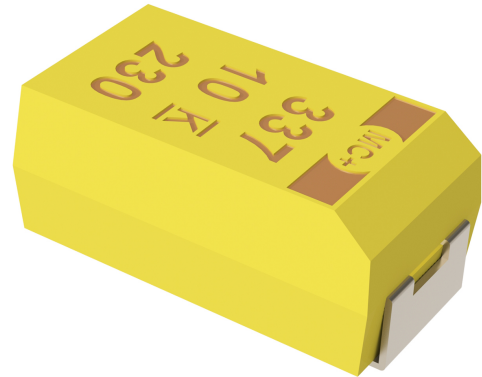

## Applications

The T513 Series is suitable for the industrial, telecom, defense and aerospace markets. Typical applications include decoupling and filtering in radar, sonar, power supply, guidance systems and other high reliability applications.

## Environmental Compliance

RoHS Compliant (6/6) according to Directive 2002/95/EC when ordered with 100% Sn solder or gold plated.

## K-SIM

For a detailed analysis of specific part numbers, please visit [ksim.kemet.com](http://ksim.kemet.com) to access KEMET's K-SIM software. KEMET K-SIM is designed to simulate behavior of components with respect to frequency, ambient temperature, and DC bias levels.

## Ordering Information

T	513	X	108	K	004	B	H	61	10	
Capacitor Class	Series	Case Size	Capacitance Code (pF)	Capacitance Tolerance	Rated Voltage (VDC)	Failure Rate/Design	Termination Finish	Surge	ESR	Packaging (C-Spec)
T = Tantalum	Multiple Anode COTS	D E X	First two digits represent significant figures. Third digit specifies number of zeros.	K = ±10% M = ±20%	004 = 4 006 = 6.3 010 = 10 016 = 16 020 = 20 025 = 25 035 = 35	A = N/A B = 0.1% /1,000 hours	C = Hot Solder Dipped H = Standard Solder Coated (SnPb 5% Pb minimum) B = Gold Plated K = Solder Fused T = 100% Tin	61 = None 62 = 10 cycles, 25°C after Weibull 63 = 10 cycles, -55°C & 85°C after Weibull 64 = 10 cycles, -55°C & 85°C before Weibull	10 = Standard ESR 20 = Low ESR 30 = Ultra Low ESR	Blank = 7" Reel 7280 = 13" Reel 7610 = Bulk Bag 7640 = Bulk plastic box WAFL = Waffle Pack

## Performance Characteristics

Item	Performance Characteristics
Operating Temperature	-55°C to 125°C
Rated Capacitance Range	15 – 1,000 µF at 120 Hz/25°C
Capacitance Tolerance	K Tolerance (10%), M Tolerance (20%)
Rated Voltage Range	4 – 35 VDC
DF (120 Hz)	Refer to Part Number Electrical Specification Table
ESR (100 kHz)	Refer to Part Number Electrical Specification Table
Leakage Current	≤ 0.01 CV (µA) at rated voltage after 5 minutes

## Qualification

Test	Condition	Characteristics				
Endurance	85°C at rated voltage, 2,000 hours 125°C at 2/3 rated voltage, 2,000 hours	Δ C/C	Within ±10% of initial value			
		DF	Within initial limits			
		DCL	Within 1.25 x initial limit			
		ESR	Within initial limits			
Storage Life	125°C at 0 volts, 2,000 hours	Δ C/C	Within ±10% of initial value			
		DF	Within initial limits			
		DCL	Within 1.25 x initial limit			
		ESR	Within initial limits			
Thermal Shock	MIL-STD-202, Method 107, Condition B, mounted, -55°C to 125°C, 1,000 cycles	Δ C/C	Within ±5% of initial value			
		DF	Within initial limits			
		DCL	Within 1.25 x initial limit			
		ESR	Within initial limits			
Temperature Stability	Extreme temperature exposure at a succession of continuous steps at +25°C, -55°C, +25°C, +85°C, +125°C, +25°C		+25°C	-55°C	+85°C	+125°C
		Δ C/C	IL*	±10%	±10%	±20%
		DF	IL	IL	1.5 x IL	1.5 x IL
		DCL	IL	n/a	10 x IL	12 x IL
Surge Voltage	25°C and 85°C, 1.32 x rated voltage 1,000 cycles (125°C, 1.2 x rated voltage)	Δ C/C	Within ±5% of initial value			
		DF	Within initial limits			
		DCL	Within initial limits			
		ESR	Within initial limits			
Mechanical Shock/ Vibration	MIL-STD-202, Method 213, Condition I, 100 G peak MIL-STD-202, Method 204, Condition D, 10 Hz to 2,000 Hz, 20 G peak	Δ C/C	Within ±10 of initial value			
		DF	Within initial limits			
		DCL	Within initial limits			
Additional Qualification Tests per MIL-PRF-55365/8	Please contact KEMET for more information.					

\*IL = Initial limit

## Dimensions – Millimeters (Inches)

Metric will govern

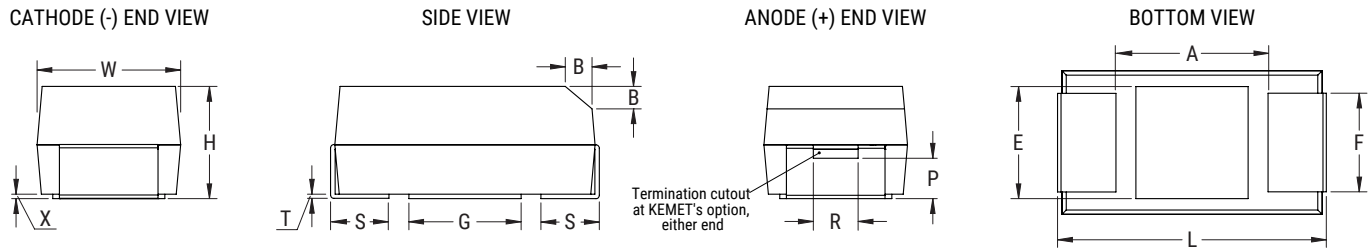

Case Size		Component													Typical Weight
KEMET	EIA	L	W	H	F ±0.1 ±(.004)	S ±0.3 ±(.012)	B ±0.15 (Ref) ±.006	X (Ref)	P (Ref)	R (Ref)	T (Ref)	A (Min)	G (Ref)	E (Ref)	(mg)
D	7343-31	7.3±0.3 (0.287±0.012)	4.3±0.3 (0.169±0.012)	2.8±0.3 (0.110±0.012)	2.4 (0.095)	1.3 (0.051)	0.5 (0.020)	0.10±0.10 (0.004±0.004)	0.9 (0.035)	1.0 (0.039)	0.13 (0.005)	3.8 (0.150)	3.5 (0.138)	3.5 (0.138)	349.43
X	7343-43	7.3±0.3 (0.287±0.012)	4.3±0.3 (0.169±0.012)	4.0±0.3 (0.157±0.012)	2.4 (0.094)	1.3 (0.051)	0.5 (0.020)	0.10±0.10 (0.004±0.004)	1.7 (0.067)	1.0 (0.039)	0.13 (0.005)	3.8 (0.150)	3.5 (0.138)	3.5 (0.138)	430.15
E	7360-38	7.3±0.3 (0.287±0.012)	6.0±0.3 (0.236±0.012)	3.6±0.2 (0.142±0.008)	4.1 (0.161)	1.3 (0.051)	0.5 (0.020)	0.10±0.10 (0.004±0.004)	0.9 (0.035)	1.0 (0.039)	0.13 (0.005)	3.8 (0.150)	3.5 (0.138)	3.5 (0.138)	500.73

Notes: (Ref) – Dimensions provided for reference only.

These weights are provided as reference. If exact weights are needed, please contact your KEMET Sales Representative.

**Table 1 – Ratings & Part Number Reference**

Rated Voltage	Rated Cap	Case Code/ Case Size	KEMET Part Number	DC Leakage	DF	Standard ESR	Low ESR	Ultra-low ESR	Maximum Operating Temp
VDC @ 85°C	µF	KEMET/EIA	(See below for part options)	µA @ +20°C Max/5 Min	% @ +20°C 120 Hz Max	mΩ @ +20°C 100 kHz Max	mΩ @ +20°C 100 kHz Max	mΩ @ +20°C 100 kHz Max	°C
4	680	X/7343-43	T513X687(1)004(2)(3)(4)(5)	27.2	6.0	30	N/A	N/A	125
4	1000	X/7343-43	T513X108(1)004(2)(3)(4)(5)	40.0	6.0	23	18	N/A	125
4	1000	E/7360-38	T513E108(1)004(2)(3)(4)(5)	40.0	6.0	18	10	N/A	125
6.3	470	X/7343-43	T513X477(1)006(2)(3)(4)(5)	29.6	6.0	30	N/A	N/A	125
6.3	680	X/7343-43	T513X687(1)006(2)(3)(4)(5)	42.8	6.0	45	23	N/A	125
6.3	680	E/7360-38	T513E687(1)006(2)(3)(4)(5)	42.8	6.0	23	12	N/A	125
10	330	X/7343-43	T513X337(1)010(2)(3)(4)(5)	33.0	6.0	35	N/A	N/A	125
16	100	D/7343-31	T513D107(1)016(2)(3)(4)(5)	16.0	6.0	75	N/A	N/A	125
16	150	X/7343-43	T513X157(1)016(2)(3)(4)(5)	24.0	6.0	40	30	N/A	125
16	220	X/7343-43	T513X227(1)016(2)(3)(4)(5)	35.2	10.0	40	25	N/A	125
20	100	X/7343-43	T513X107(1)020(2)(3)(4)(5)	20.0	8.0	45	40	35	125
25	68	X/7343-43	T513X686(1)025(2)(3)(4)(5)	17.0	8.0	45	N/A	N/A	125
25	100	E/7360-38	T513E107(1)025(2)(3)(4)(5)	25.0	8.0	50	N/A	N/A	125
35	15	D/7343-31	T513D156(1)035(2)(3)(4)(5)	5.3	6.0	100	N/A	N/A	125
35	33	X/7343-43	T513X336(1)035(2)(3)(4)(5)	11.6	6.0	65	55	N/A	125
35	47	X/7343-43	T513X476(1)035(2)(3)(4)(5)	16.5	8.0	65	55	N/A	125
VDC @ 85°C	µF	KEMET/EIA	(See below for part options)	µA @ +20°C Max/5 Min	% @ +20°C 120 Hz Max	mΩ @ +20°C 100 kHz Max	mΩ @ +20°C 100 kHz Max	mΩ @ +20°C 100 kHz Max	°C
Rated Voltage	Rated Cap	Case Code/ Case Size	KEMET Part Number	DC Leakage	DF	Standard ESR	Low ESR	Ultra-low ESR	Maximum Operating Temp

(1) To complete KEMET part number, insert M for ±20%, K for ±10%. Designates Capacitance tolerance.

(2) To complete KEMET part number, insert B (0.1%/1,000 hours), or A = N/A. Designates Reliability Level.

(3) To complete KEMET part number, insert B = Gold Plated, C = Hot solder dipped, H = Solder Plated, K = Solder Fused or T = 100% Tin (Sn). Designates Termination Finish.

(4) To complete KEMET part number, insert 61 = None, 62 = 10 cycles +25°C, 63 = 10 cycles -55°C +85°C after Weibull or 64 = 10 cycles -55°C +85°C before Weibull. Designates Surge current option.

(5) To complete KEMET part number, insert 10 = Standard ESR, 20 = Low ESR or 30 = Ultra Low ESR. Designates ESR option.

Refer to Ordering Information for additional detail.

## Recommended Voltage Derating Guidelines

	-55°C to 85°C	85°C to 125°C
% Change in Working DC Voltage with Temperature	V <sub>R</sub>	67% of V <sub>R</sub>
Recommended Maximum Application Voltage	50% of V <sub>R</sub>	33% of V <sub>R</sub>



## Ripple Current/Ripple Voltage

Permissible AC ripple voltage and current are related to equivalent series resistance (ESR) and the power dissipation capabilities of the device. Permissible AC ripple voltage which may be applied is limited by two criteria:

1. The positive peak AC voltage plus the DC bias voltage, if any, must not exceed the DC voltage rating of the capacitor.
2. The negative peak AC voltage in combination with bias voltage, if any, must not exceed the allowable limits specified for reverse voltage. See the Reverse Voltage section for allowable limits.

The maximum power dissipation by case size can be determined using the table at right. The maximum power dissipation rating stated in the table must be reduced with increasing environmental operating temperatures. Refer to the table below for temperature compensation requirements.

KEMET Case Code	EIA Case Code	Maximum Power Dissipation (P max) mWatts at 25°C w/+20°C Rise
A	3216-18	75
B	3528-21	85
C	6032-28	110
D	7343-31	150
X	7343-43	165
E	7360-38	200
S	3216-12	60
T	3528-12	70
U	6032-15	90
V	7343-20	125
T510X	7343-43	270
T510E	7360-38	285

Temperature Compensation Multipliers for Maximum Ripple Current		
T ≤ 25°C	T ≤ 85°C	T ≤ 125°C
1.00	0.90	0.40

T = Environmental Temperature

The maximum power dissipation rating must be reduced with increasing environmental operating temperatures. Refer to the Temperature Compensation Multiplier table for details.

Using the P max of the device, the maximum allowable rms ripple current or voltage may be determined.

$$I(max) = \sqrt{P_{max}/R}$$

$$E(max) = Z \sqrt{P_{max}/R}$$

I = rms ripple current (amperes)

E = rms ripple voltage (volts)

P max = maximum power dissipation (watts)

R = ESR at specified frequency (ohms)

Z = Impedance at specified frequency (ohms)

## Reverse Voltage

Solid tantalum capacitors are polar devices and may be permanently damaged or destroyed if connected with the wrong polarity. The positive terminal is identified on the capacitor body by a stripe, plus in some cases a beveled edge. A small degree of transient reverse voltage is permissible for short periods per the below table. The capacitors should not be operated continuously in reverse mode, even within these limits.

Temperature	Permissible Transient Reverse Voltage
25°C	15% of Rated Voltage
85°C	5% of Rated Voltage
125°C	1% of Rated Voltage

**Table 2 – Land Dimensions/Courtyard**

KEMET	Metric Size Code	Density Level A: Maximum (Most) Land Protrusion (mm)					Density Level B: Median (Nominal) Land Protrusion (mm)					Density Level C: Minimum (Least) Land Protrusion (mm)						
		Case	EIA	W	L	S	V1	V2	W	L	S	V1	V2	W	L	S	V1	V2
		D	7343-31	2.55	2.77	3.67	10.22	5.60	2.43	2.37	3.87	9.12	5.10	2.33	1.99	4.03	8.26	4.84
		E <sup>1</sup>	7360-38	4.25	2.77	3.67	10.22	7.30	4.13	2.37	3.87	9.12	6.80	4.03	1.99	4.03	8.26	6.54
		X <sup>1</sup>	7343-43	2.55	2.77	3.67	10.22	5.60	2.43	2.37	3.87	9.12	5.10	2.33	1.99	4.03	8.26	4.84

**Density Level A:** For low-density product applications. Recommended for wave solder applications and provides a wider process window for reflow solder processes.

**Density Level B:** For products with a moderate level of component density. Provides a robust solder attachment condition for reflow solder processes.

**Density Level C:** For high component density product applications. Before adapting the minimum land pattern variations the user should perform qualification testing based on the conditions outlined in IPC standard 7351 (IPC-7351).

<sup>1</sup> Height of these chips may create problems in wave soldering.

<sup>2</sup> Land pattern geometry is too small for silkscreen outline.

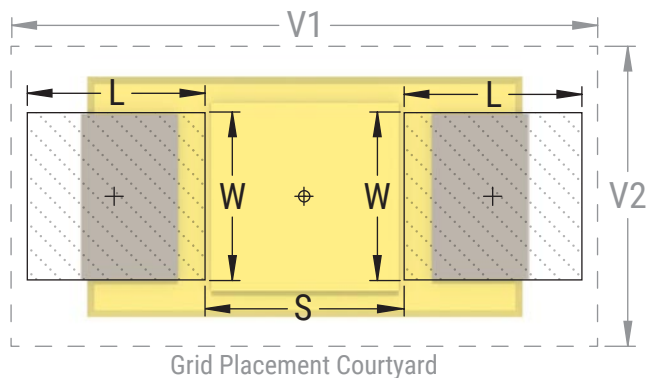

## Soldering Process

KEMET’s families of surface mount capacitors are compatible with wave (single or dual), convection, IR, or vapor phase reflow techniques. Preheating of these components is recommended to avoid extreme thermal stress. KEMET’s recommended profile conditions for convection and IR reflow reflect the profile conditions of the IPC/J-STD-020D standard for moisture sensitivity testing. The devices can safely withstand a maximum of three reflow passes at these conditions.

Please note that although the X/7343-43 case size can withstand wave soldering, the tall profile (4.3 mm maximum) dictates care in wave process development.

Hand soldering should be performed with care due to the difficulty in process control. If performed, care should be taken to avoid contact of the soldering iron to the molded case. The iron should be used to heat the solder pad, applying solder between the pad and the termination, until reflow occurs. Once reflow occurs, the iron should be removed immediately. “Wiping” the edges of a chip and heating the top surface is not recommended.

During typical reflow operations, a slight darkening of the gold-colored epoxy may be observed. This slight darkening is normal and not harmful to the product. Marking permanency is not affected by this change.

Profile Feature	SnPb Assembly	Pb-Free Assembly
<b>Preheat/Soak</b>		
Temperature Minimum ( $T_{smin}$ )	100°C	150°C
Temperature Maximum ( $T_{smax}$ )	150°C	200°C
Time ( $t_s$ ) from $T_{smin}$ to $T_{smax}$	60 – 120 seconds	60 – 120 seconds
Ramp-up Rate ( $T_L$ to $T_P$ )	3°C/seconds maximum	3°C/seconds maximum
Liquidous Temperature ( $T_L$ )	183°C	217°C
Time Above Liquidous ( $t_L$ )	60 – 150 seconds	60 – 150 seconds
Peak Temperature ( $T_P$ )	220°C* 235°C**	250°C* 260°C**
Time within 5°C of Maximum Peak Temperature ( $t_p$ )	20 seconds maximum	30 seconds maximum
Ramp-down Rate ( $T_P$ to $T_L$ )	6°C/seconds maximum	6°C/seconds maximum
Time 25°C to Peak Temperature	6 minutes maximum	8 minutes maximum

Note: All temperatures refer to the center of the package, measured on the package body surface that is facing up during assembly reflow.

\*Case Size D, E, P, Y, and X

\*\*Case Size A, B, C, H, I, K, M, R, S, T, U, V, W, and Z

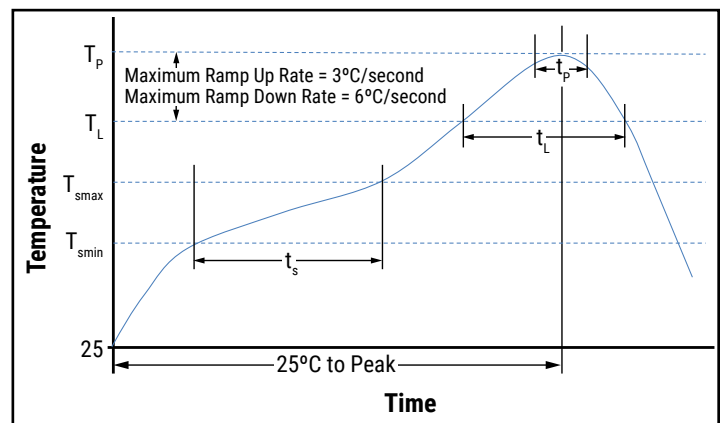

## Storage

Tantalum chip capacitors should be stored in normal working environments. While the chips themselves are quite robust in other environments, solderability will be degraded by exposure to high temperatures, high humidity, corrosive atmospheres, and long term storage. In addition, packaging materials will be degraded by high temperature – reels may soften or warp and tape peel force may increase. KEMET recommends that maximum storage temperature not exceed 40°C and maximum storage humidity not exceed 60% relative humidity. Temperature fluctuations should be minimized to avoid condensation on the parts and atmospheres should be free of chlorine and sulphur bearing compounds. For optimized solderability chip stock should be used promptly, preferably within three years of receipt.



## Construction

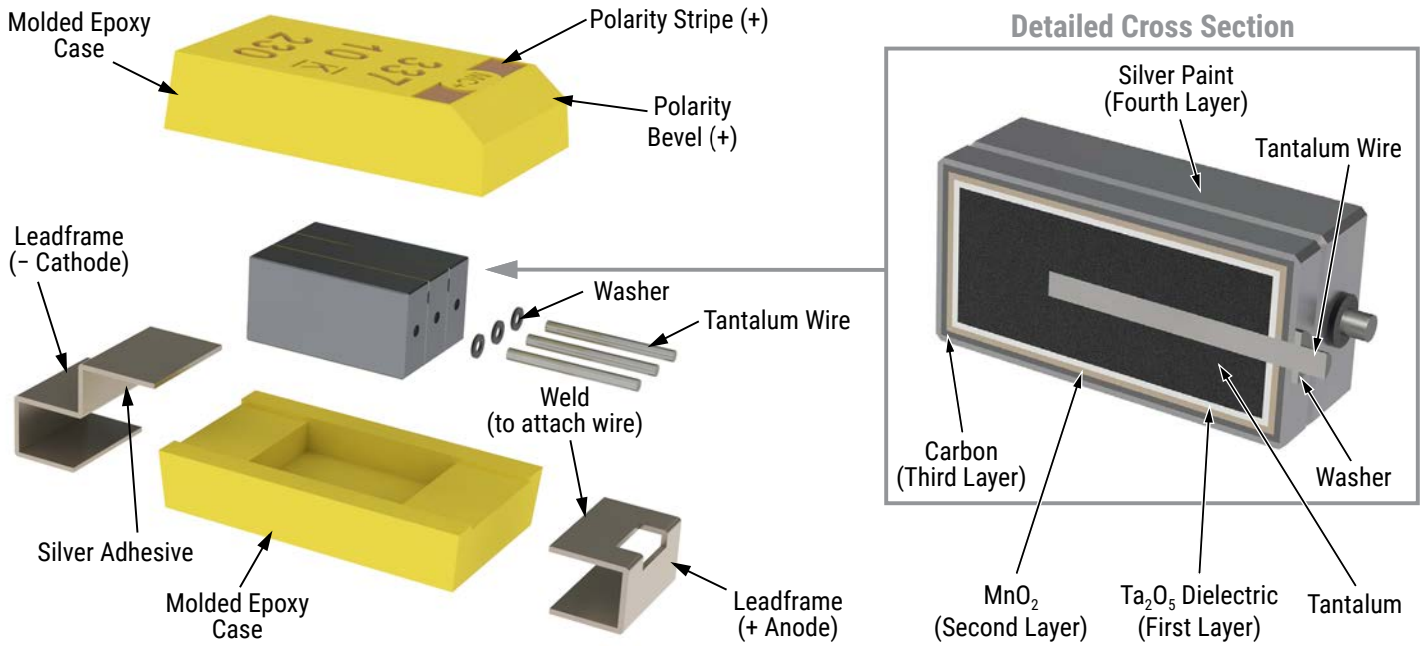

## Capacitor Marking

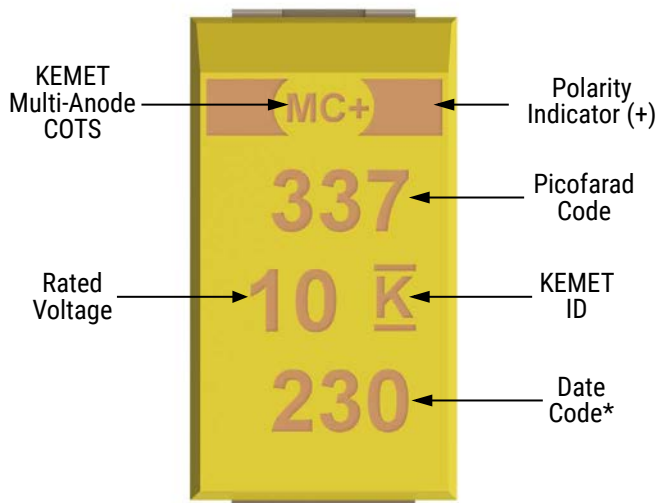

\* 230 = 30<sup>th</sup> week of 2012

Date Code *	
1 <sup>st</sup> digit = Last number of Year	2 = 2012 3 = 2013 4 = 2014 5 = 2015 6 = 2016 7 = 2017
2 <sup>nd</sup> and 3 <sup>rd</sup> digit = Week of the Year	01 = 1 <sup>st</sup> week of the Year to 52 = 52 <sup>nd</sup> week of the Year

## Tape & Reel Packaging Information

KEMET’s molded chip capacitor families are packaged in 8 and 12 mm plastic tape on 7" and 13" reels in accordance with *EIA Standard 481: Embossed Carrier Taping of Surface Mount Components for Automatic Handling*. This packaging system is compatible with all tape-fed automatic pick-and-place systems.

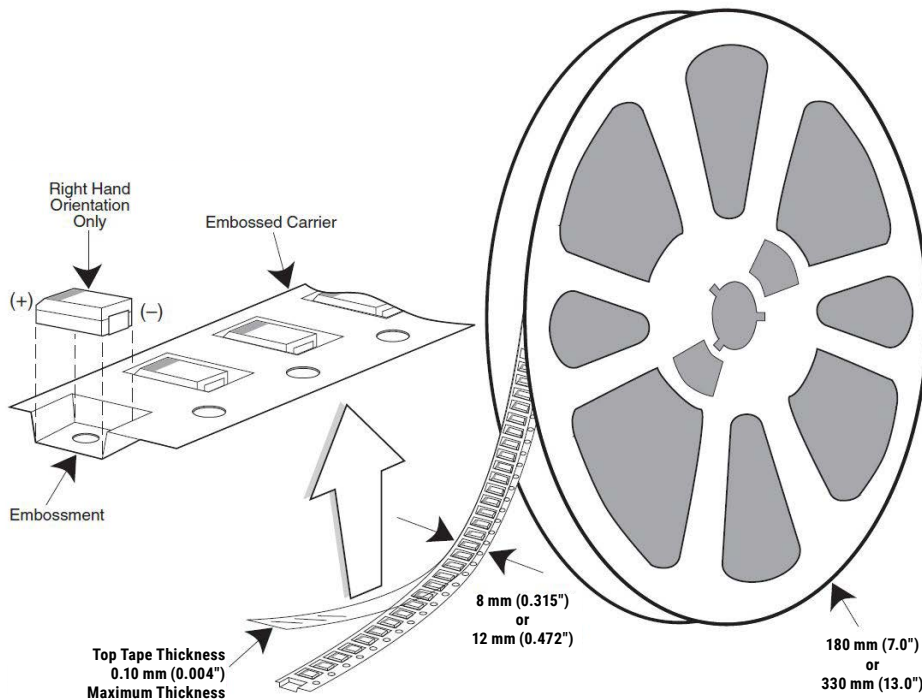
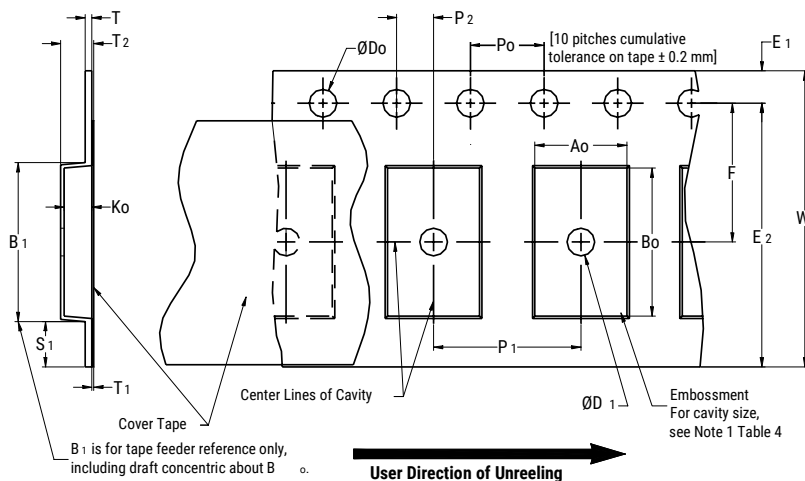

**Table 3 – Packaging Quantity**

Case Code		Tape Width (mm)	7" Reel*	13" Reel*
KEMET	EIA			
S	3216-12	8	2,500	10,000
T	3528-12	8	2,500	10,000
M	3528-15	8	2,000	8,000
U	6032-15	12	1,000	5,000
L	6032-19	12	1,000	3,000
W	7343-15	12	1,000	3,000
Z	7343-17	12	1,000	3,000
V	7343-20	12	1,000	3,000
A	3216-18	8	2,000	9,000
B	3528-21	8	2,000	8,000
C	6032-28	12	500	3,000
D	7343-31	12	500	2,500
Q	7343-12	12	1,000	3,000
Y	7343-40	12	500	2,000
X	7343-43	12	500	2,000
E/T428P	7360-38	12	500	2,000
H	7360-20	12	1,000	2,500

\* No C-Spec required for 7" reel packaging. C-7280 required for 13" reel packaging.

**Figure 1 – Embossed (Plastic) Carrier Tape Dimensions**



**Table 4 – Embossed (Plastic) Carrier Tape Dimensions**

Metric will govern

Constant Dimensions – Millimeters (Inches)											
Tape Size	D <sub>0</sub>	D <sub>1</sub> Minimum Note 1	E <sub>1</sub>	P <sub>0</sub>	P <sub>2</sub>	R Reference Note 2	S <sub>1</sub> Minimum Note 3	T Maximum	T <sub>1</sub> Maximum		
8 mm	1.5+0.10/-0.0 (0.059+0.004/-0.0)	1.0 (0.039)	1.75±0.10 (0.069±0.004)	4.0±0.10 (0.157±0.004)	2.0±0.05 (0.079±0.002)	25.0 (0.984)	0.600 (0.024)	0.600 (0.024)	0.100 (0.004)		
12 mm		1.5 (0.059)								2.0±0.1 (0.079±0.059)	30 (1.181)
16 mm											

Variable Dimensions – Millimeters (Inches)									
Tape Size	Pitch	B <sub>1</sub> Maximum Note 4	E <sub>2</sub> Minimum	F	P <sub>1</sub>	T <sub>2</sub> Maximum	W Maximum	A <sub>0</sub> , B <sub>0</sub> & K <sub>0</sub>	
8 mm	Single (4 mm)	4.35 (0.171)	6.25 (0.246)	3.5±0.05 (0.138±0.002)	2.0±0.05 or 4.0±0.10 (0.079±0.002 or 0.157±0.004)	2.5 (0.098)	8.3 (0.327)	Note 5	
12 mm	Single (4 mm) & Double (8 mm)	8.2 (0.323)	10.25 (0.404)	5.5±0.05 (0.217±0.002)	2.0±0.05 (0.079±0.002) or 4.0±0.10 (0.157±0.004) or 8.0±0.10 (0.315 ±0.004)	4.6 (0.181)	12.3 (0.484)		
16 mm	Triple (12 mm)	12.1 (0.476)	14.25 (0.561)	7.5±0.10 (0.295±0.004)	4.0±0.10 (0.157±0.004) to 12.0±0.10 (0.472±0.004)	8.0 (0.315)	16.3 (0.642)		

1. The embossment hole location shall be measured from the sprocket hole controlling the location of the embossment. Dimensions of embossment location and hole location shall be applied independent of each other.
2. The tape, with or without components, shall pass around R without damage (see Figure 4).
3. If S<sub>1</sub> < 1.0 mm, there may not be enough area for cover tape to be properly applied (see EIA Standard 481–D, paragraph 4.3, section b).
4. B<sub>1</sub> dimension is a reference dimension for tape feeder clearance only.
5. The cavity defined by A<sub>0</sub>, B<sub>0</sub> and K<sub>0</sub> shall surround the component with sufficient clearance that:
  - (a) the component does not protrude above the top surface of the carrier tape.
  - (b) the component can be removed from the cavity in a vertical direction without mechanical restriction, after the top cover tape has been removed.
  - (c) rotation of the component is limited to 20° maximum for 8 and 12 mm tapes and 10° maximum for 16 mm tapes (see Figure 2).
  - (d) lateral movement of the component is restricted to 0.5 mm maximum for 8 mm and 12 mm wide tape and to 1.0 mm maximum for 16 mm tape (see Figure 3).
  - (e) see Addendum in EIA Standard 481–D for standards relating to more precise taping requirements.

## Packaging Information Performance Notes

- Cover Tape Break Force:** 1.0 Kg minimum.
- Cover Tape Peel Strength:** The total peel strength of the cover tape from the carrier tape shall be:

Tape Width	Peel Strength
8 mm	0.1 to 1.0 Newton (10 to 100 gf)
12 and 16 mm	0.1 to 1.3 Newton (10 to 130 gf)

The direction of the pull shall be opposite the direction of the carrier tape travel. The pull angle of the carrier tape shall be 165° to 180° from the plane of the carrier tape. During peeling, the carrier and/or cover tape shall be pulled at a velocity of 300 ±10 mm/minute.

- Labeling:** Bar code labeling (standard or custom) shall be on the side of the reel opposite the sprocket holes. Refer to EIA Standards 556 and 624.

## Figure 2 – Maximum Component Rotation



## Figure 3 – Maximum Lateral Movement



## Figure 4 – Bending Radius

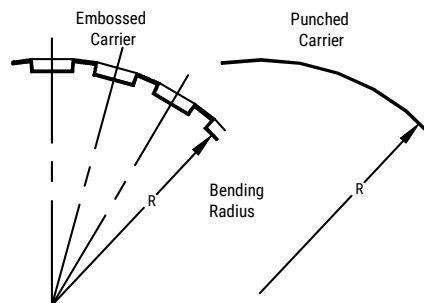

**Figure 5 – Reel Dimensions**



Note: Drive spokes optional; if used, dimensions B and D shall apply.

**Table 5 – Reel Dimensions**

Metric will govern

Constant Dimensions – Millimeters (Inches)				
Tape Size	A	B Minimum	C	D Minimum
8 mm	178±0.20 (7.008±0.008)	1.5 (0.059)	13.0+0.5/-0.2 (0.521+0.02/-0.008)	20.2 (0.795)
12 mm	or			
16 mm	330±0.20 (13.000±0.008)			
Variable Dimensions – Millimeters (Inches)				
Tape Size	N Minimum	W <sub>1</sub>	W <sub>2</sub> Maximum	W <sub>3</sub>
8 mm	50 (1.969)	8.4+1.5/-0.0 (0.331+0.059/-0.0)	14.4 (0.567)	Shall accommodate tape width without interference
12 mm		12.4+2.0/-0.0 (0.488+0.078/-0.0)	18.4 (0.724)	
16 mm		16.4+2.0/-0.0 (0.646+0.078/-0.0)	22.4 (0.882)	

**Figure 6 – Tape Leader & Trailer Dimensions**

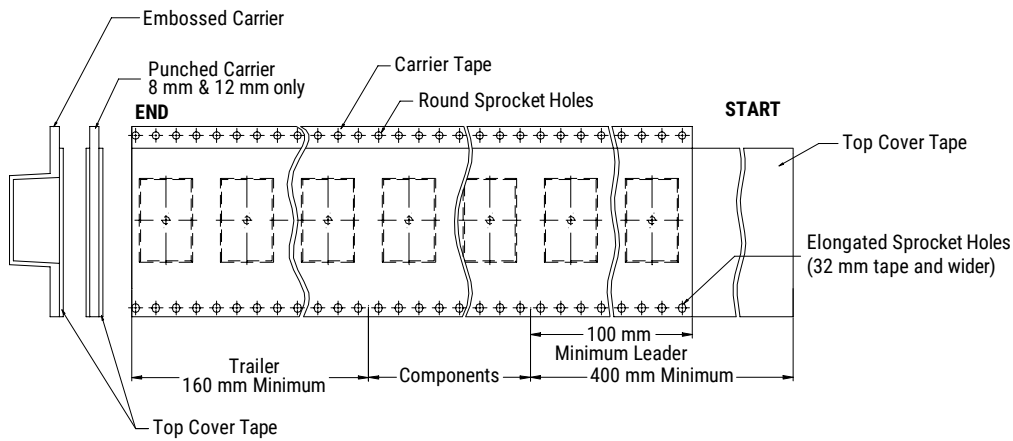

**Figure 7 – Maximum Camber**

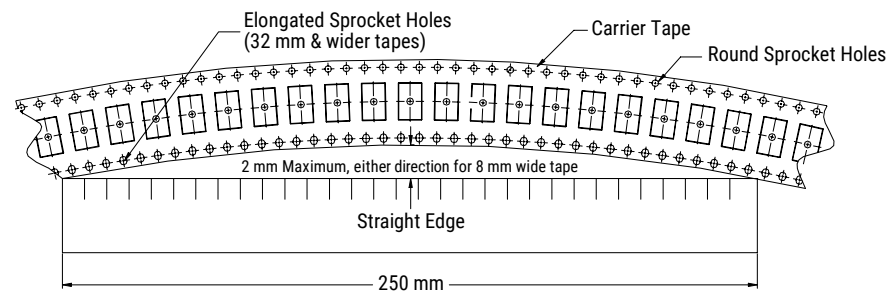

## KEMET Electronics Corporation Sales Offices

For a complete list of our global sales offices, please visit [www.kemet.com/sales](http://www.kemet.com/sales).

---

### Disclaimer

All product specifications, statements, information and data (collectively, the "Information") in this datasheet are subject to change. The customer is responsible for checking and verifying the extent to which the Information contained in this publication is applicable to an order at the time the order is placed.

All Information given herein is believed to be accurate and reliable, but it is presented without guarantee, warranty, or responsibility of any kind, expressed or implied.

Statements of suitability for certain applications are based on KEMET Electronics Corporation's ("KEMET") knowledge of typical operating conditions for such applications, but are not intended to constitute – and KEMET specifically disclaims – any warranty concerning suitability for a specific customer application or use. The Information is intended for use only by customers who have the requisite experience and capability to determine the correct products for their application. Any technical advice inferred from this Information or otherwise provided by KEMET with reference to the use of KEMET's products is given gratis, and KEMET assumes no obligation or liability for the advice given or results obtained.

Although KEMET designs and manufactures its products to the most stringent quality and safety standards, given the current state of the art, isolated component failures may still occur. Accordingly, customer applications which require a high degree of reliability or safety should employ suitable designs or other safeguards (such as installation of protective circuitry or redundancies) in order to ensure that the failure of an electrical component does not result in a risk of personal injury or property damage.

Although all product-related warnings, cautions and notes must be observed, the customer should not assume that all safety measures are indicated or that other measures may not be required.