

Polymer Aluminum, 125C, A700, 150 uF, 20%, 6.3 V, -55/+125C

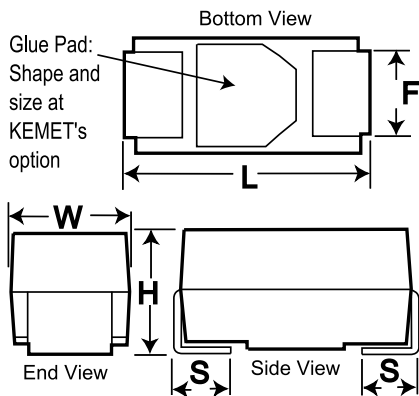

General Information	
<b>Dielectric:</b>	Polymer Aluminum
<b>Style:</b>	SMD Chip
<b>Series:</b>	A700
<b>Footprint:</b>	7343
<b>Description:</b>	Surface Mount, Polymer Aluminum
<b>RoHS:</b>	Yes
<b>Termination:</b>	Tin
<b>Notes:</b>	D/7343-31

Dimensions	
<b>L</b>	7.3mm +/-0.3mm
<b>W</b>	4.3mm +/-0.3mm
<b>H</b>	2.8mm +/-0.3mm
<b>S</b>	1.3mm +/-0.3mm
<b>F</b>	2.4mm +/-0.1mm

Packaging Specifications	
<b>Weight:</b>	196.58 mg
<b>Packaging:</b>	T&R, 180mm
<b>Packaging Quantity:</b>	500

Specifications	
<b>Capacitance:</b>	150 uF
<b>Capacitance Tolerance:</b>	20%
<b>Voltage DC:</b>	6.3 VDC
<b>Temperature Range:</b>	-55/+125C
<b>Rated Temperature:</b>	125C
<b>Dissipation Factor:</b>	6%
<b>Resistance:</b>	10 mOhms (100kHz)
<b>Current:</b>	5000 mAmps (100kHz)
<b>Leakage Current:</b>	37.8 uAmps (5min 20C)

Statements of suitability for certain applications are based on our knowledge of typical operating conditions for such applications, but are not intended to constitute - and we specifically disclaim - any warranty concerning suitability for a specific customer application or use. This Information is intended for use only by customers who have the requisite experience and capability to determine the correct products for their application. Any technical advice inferred from this Information or otherwise provided by us with reference to the use of our products is given gratis, and we assume no obligation or liability for the advice given or results obtained.