

Bus system flat-type plug - SACC-DSI-MSD-4CON-M12 SCO - 1551859

Please be informed that the data shown in this PDF Document is generated from our Online Catalog. Please find the complete data in the user's documentation. Our General Terms of Use for Downloads are valid (<http://phoenixcontact.com/download>)



Bus system flush-type plug, 4-pos., M12 SPEEDCON, D-coded, rear/screw mounting with M12 thread, with straight solder connection

Why buy this product

- ✓ Easy PCB assembly: one-piece connectors for wave soldering
- ✓ All standard pin assignments and codings for signal, data, and power transmission with a uniform design-in design
- ✓ SPEEDCON fast locking system reduces cabling times



Key Commercial Data

Packing unit	20 STK
Minimum order quantity	20 STK
GTIN	 4 046356 161916
GTIN	4046356161916
Weight per Piece (excluding packing)	8.300 g
Custom tariff number	85366990
Country of origin	Germany
Note	Made to Order (non-returnable)

Technical data

Ambient conditions

Ambient temperature (operation)	-25 °C ... 85 °C (Plug / socket)
	-40 °C ... 85 °C (without mechanical actuation)
Degree of protection	IP67

General

Note	The electrical and mechanical data specified assume that the connector pair is correctly locked and mounted. If the connector is unlocked and if there is a danger of contamination, the connector must be sealed using a protective cap > IP54. Influences arising from litz wires, cables or PCB assembly must also be taken into consideration.
------	--

Bus system flat-type plug - SACC-DSI-MSD-4CON-M12 SCO - 1551859

Technical data

General

Rated current at 40°C	4 A
Rated voltage	250 V
Rated surge voltage	2.5 kV
Number of positions	4
Insulation resistance	≥ 100 MΩ
Coding	D - data
Standards/regulations	M12 connector IEC 61076-2-101
Status display	No
Overvoltage category	II
Degree of pollution	3
Connection method	Solder pins
Insertion/withdrawal cycles	> 100
Torque	3 Nm ... 4 Nm (Installation-side)
Mounting type	Rear mounting M12 x 1 With locking nut

Material

Flammability rating according to UL 94	V0
Contact material	CuZn
Contact surface material	Au
Contact carrier material	PA 66
Material, knurls	Zinc die-cast, nickel-plated
Sealing material	NBR

Cable

Standards/specifications	M12 connector IEC 61076-2-101
Ambient temperature (operation)	-40 °C ... 85 °C (cable, fixed installation)
	-25 °C ... 85 °C (cable, flexible installation)

Standards and Regulations

Standard designation	M12 connector
Standards/regulations	IEC 61076-2-101
Flammability rating according to UL 94	V0

Environmental Product Compliance

China RoHS	Environmentally Friendly Use Period = 50
	For details about hazardous substances go to tab "Downloads", Category "Manufacturer's declaration"

Drawings

Bus system flat-type plug - SACC-DSI-MSD-4CON-M12 SCO - 1551859

Dimensional drawing

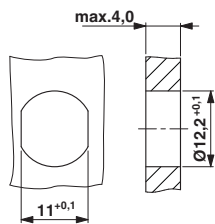

Schematic diagram

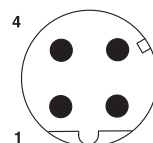

Pin assignment M12 male connector, 4-pos., D-coded, male side

Panel cutout

Dimensional drawing

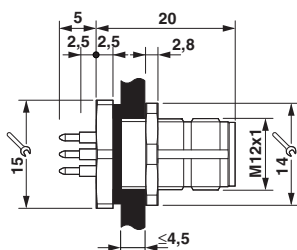

Drilling diagram

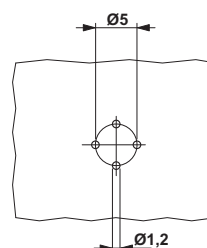

M12 flush-type connector

Dimensional drawing

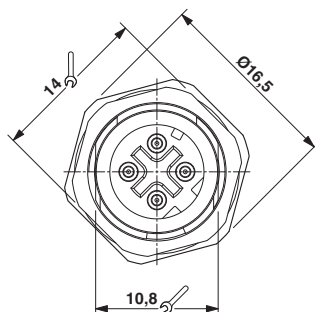

Front view of M12 flush-type connector

Classifications

eCl@ss

eCl@ss 4.0	27250313
eCl@ss 4.1	27250313
eCl@ss 5.0	27143423
eCl@ss 5.1	27143423
eCl@ss 6.0	27143423
eCl@ss 7.0	27449001
eCl@ss 8.0	27440103
eCl@ss 9.0	27440102

Bus system flat-type plug - SACC-DSI-MSD-4CON-M12 SCO - 1551859

Classifications

ETIM

ETIM 3.0	EC002061
ETIM 4.0	EC000830
ETIM 5.0	EC002061
ETIM 6.0	EC002061

UNSPSC

UNSPSC 6.01	31261501
UNSPSC 7.0901	31261501
UNSPSC 11	31261501
UNSPSC 12.01	31261501
UNSPSC 13.2	39121413

Approvals

Approvals

Approvals

UL Recognized / cULus Recognized / EAC

Ex Approvals

Approval details

UL Recognized		http://database.ul.com/cgi-bin/XYV/template/LISEXT/1FRAME/index.htm	FILE E 118976
mm ² /AWG/kcmil	26-20		
Nominal current I _N	4 A		
Nominal voltage U _N	250 V		

cULus Recognized		http://database.ul.com/cgi-bin/XYV/template/LISEXT/1FRAME/index.htm	E221474-20140616
mm ² /AWG/kcmil	22-20		
Nominal current I _N	4 A		
Nominal voltage U _N	250 V		

Bus system flat-type plug - SACC-DSI-MSD-4CON-M12 SCO - 1551859

Approvals

EAC



B.01742

Accessories

Accessories

Protective cap

Sealing cap - PROT-M12 FS - 1560251



M12 sealing cap for unoccupied M12 plugs of the sensor/actuator cable, flush-type plugs and I/O devices in the field

Sealing cap - PROT-M12 FS-M - 1430488



M12 metal sealing cap for unoccupied M12 plugs of the sensor/actuator cable, flush-type plugs and I/O devices in the field