



Main

Range of product	Phaseo
Product or component type	Battery control module
Input voltage	24...28.8 V DC
Output voltage	(U _{battery} -0.5) V in battery mode DC (U _{in} -0.25) V in nominal mode DC
Maximum output current	40 A

Complementary

Input voltage limits	22...30 V
Current consumption	0.1 mA, no load <= 40.6 A 0.6 A, on load
Power dissipation in W	< 12 W
Activation threshold	Adjustable 22...36 V
Number of output channels	1
Output protection type	Against overload, protection technology: 1.5 x I _n Against short-circuits, protection technology: battery-backed mode, automatic reset Against short-circuits, protection technology: power-supplied mode
Connections - terminals	Screw type terminals for input connection, connection capacity: 2 x 0.5...2 x 10 mm ² AWG 20...AWG 8 Screw type terminals for output connection, connection capacity: 2 x 0.5...2 x 10 mm ² AWG 20...AWG 8 Removable screw terminal block for diagnostic relay, connection capacity: 1 x 0.75 mm ²
Fixing mode	By clips on 35 mm symmetrical DIN rail, operating position: horizontal By clips on 35 mm symmetrical DIN rail, operating position: vertical
Marking	CE
Name of test	Conducted/Radiated emissions conforming to EN 55022 Class B, 20 % derating factor Electrostatic discharges conforming to EN/IEC 61000-4-2 Emission conforming to EN 61000-6-3 Induced electromagnetic field conforming to EN/IEC 61000-4-6 level 3 Radiated electromagnetic field conforming to EN/IEC 61000-4-3 level 3 Rapid transient conforming to IEC 61000-4-4 level 3

Disclaimer: This documentation is not intended as a substitute for and is not to be used for determining suitability or reliability of these products for specific user applications

Surge conforming to EN/IEC 61000-4-5 level 2

Local signalling	1 C/O relay, function: alarm status 1 C/O relay, function: battery status 1 C/O relay, function: power supply status LCD screen, function: module status
Product weight	0.7 kg

Environment

IP degree of protection	Conforming to EN/IEC 60529
Ambient air temperature for operation	-25...60 °C
Ambient air temperature for storage	-40...85 °C
Relative humidity	0...90 % during operation 0...95 % during storage
Overvoltage category	Class II conforming to VDE 0106-1
Vibration resistance	3.5 mm (f = 3...11.9 Hz) conforming to EN/IEC 61131-2 2 gn (f = 11.9...150 Hz) conforming to EN/IEC 61131-2
Dielectric strength	500 V between input and ground 500 V between output and ground
Product certifications	RCM EAC
Standards	UL 508 CSA C22.2 No 60950-1
Environmental characteristic	EMC conforming to EN 61000-6-3 EMC conforming to EN/IEC 61000-6-2 Safety conforming to EN/IEC 60950-1 Safety conforming to EN/IEC 61204-3

Offer Sustainability

Sustainable offer status	Not Green Premium product
RoHS (date code: YYWW)	Compliant - since 0501 - Schneider Electric declaration of conformity Schneider Electric declaration of conformity
REACH	Reference contains SVHC above the threshold - Go to CaP for more details Go to CaP for more details
Product environmental profile	Available End of life manual

Contractual warranty

Warranty period	18 months
-----------------	-----------

24 Vdc/40 A Battery Control Module

Dimensions

mm
inch

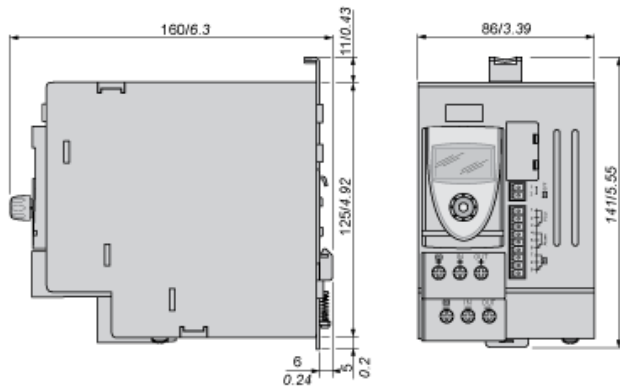

24 Vdc Battery Control Module

Mounting

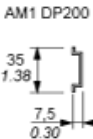
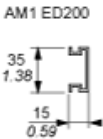
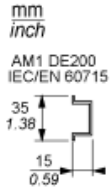

24 Vdc Battery Control Module

Clearance

mm
inch

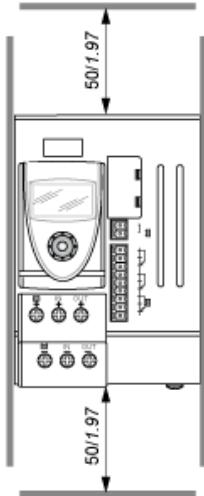

24 Vdc Battery Control Module

Wiring Diagram

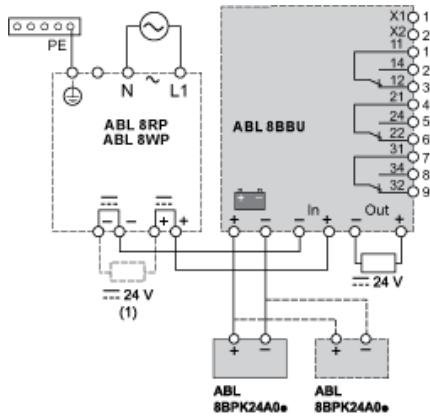







(1) See table below for the maximum unstored charge capacity (μF)



ABL	Max. Unstored Charge Capacity (μF)
8RPS24030	30 000
8RPS24050	50 000
8RPS24100	100 000
8RPS24200	100 000
8RPS24400	100 000

24 Vdc Battery Control Module

Outputs States (U = 24 Vdc: I > 5 mA, U = 230 Vac: I < 500 mA)

	No power from the power supply		Power from the power supply
	Alarm or device not supplied		No alarm
	No power from the battery pack		Power from the battery pack







Inputs States (Dry Contact)

	Operational battery		Battery inhibited
---	---------------------	---	-------------------

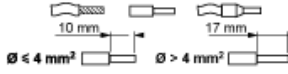





Wiring Requirements

Cable Types and Wire Sizes

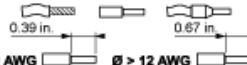
IEC / EN

		ABL 8RPS24030 8RPS24050 8RPS24100	ABL 8RPM24200 8WPS24200 8WPS24400
			
$\varnothing \leq 4 \text{ mm}^2$			
$\varnothing > 4 \text{ mm}^2$			
ABL 8BBU24200	In + / -	1...4 mm ²	4...10 mm ²
	 + / -	6 mm ²	-
	Out + / -	6 mm ²	-
ABL 8BBU24400	In + / -	1...4 mm ²	4...10 mm ²
	 + / -	10 mm ²	-
	Out + / -	10 mm ²	-
	 ⊕	10 mm ²	-
		-	-
 OFF / PSU / Alarm / 		0,14...1 mm ²	-

UL

		ABL 8RPS24030 8RPS24050 8RPS24100	ABL 8RPM24200 8WPS24200 8WPS24400
			
$\varnothing \leq 12 \text{ AWG}$			
$\varnothing > 12 \text{ AWG}$			
ABL 8BBU24200	In + / -	16...12 AWG	12...6 AWG
	 + / -	10 AWG	-
	Out + / -	10 AWG	-
ABL 8BBU24400	In + / -	16...12 AWG	12...6 AWG
	 + / -	6 AWG	-
	Out + / -	6 AWG	-
	 ⊕	6 AWG	-
		-	-
 OFF / PSU / Alarm / 		26...16 AWG	-