



## GDSN 307 schwarz/black

Industrial Connectors:Rectangular connectors GDM-series:Type CEN 175301-803 (DIN 43650):Cable socket

### Product description

Description	cable socket with central screw M 2.5 x 27
Type	GDSN 307 schwarz/black
Order No.	933 023-100
Other standard types	grey housing, Order No. 933 023-106
Number of contacts	3 + PE
Cable gland	PG 7
Conductor size	max. 0.75 mm <sup>2</sup>
Standard	DIN EN 175 301-803-C
Housing Color	black
Construction type	C

### Drawing

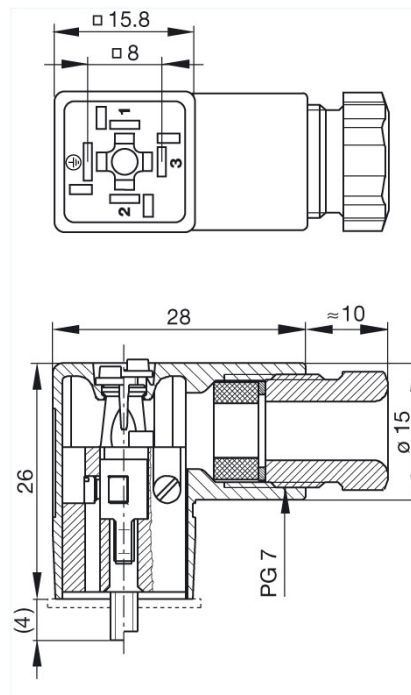

### Technical data

Pin dimensions	2,8 mm x 0,5 mm, 3,6 mm x 0,5 mm
Rated voltage	AC/DC 250 V
Rated current	6 A
Contact resistance	$\leq 4$ mOhm
Type of termination	screw
Suitable cables	4.5 mm to 6 mm

Mounting central screw

**Material**

Contact surface material Sn

Contact bearer material PA

Housing material PA

**Environmental conditions**

Protection class (IEC 60529) IP 65

Pollution severity 3

Temperature range -40 °C to +125 °C

**Inflammability class**

Housing 94 HB

Contact bearer 94 V-2

**Approvals**

UR UR

VDE VDE

SEV SEV

CSA CSA

**Packing unit**

Packaging unit 200 pieces

**Scope of delivery and accessories**

Accessories to order separately (NBR) flat gasket GDSN 307-4,  
Order No. 730 176-002;  
(EPDM) flat gasket GDSN 307-5,  
Order No. 730 310-004