

ATV212HU55M3X

variable speed drive ATV212 - 5.5kW - 7.5hp -
240V - 3ph - wo EMC - IP21



Main

| | |
|------------------------------|------------------------------|
| Range of product | Altivar 212 |
| Product or component type | Variable speed drive |
| Device short name | ATV212 |
| Product destination | Asynchronous motors |
| Product specific application | Pumps and fans in HVAC |
| Assembly style | With heat sink |
| Network number of phases | 3 phases |
| Motor power kW | 5.5 kW |
| Motor power hp | 7.5 hp |
| [Us] rated supply voltage | 200...240 V - 15...10 % |
| Supply voltage limits | 170...264 V |
| Supply frequency | 50...60 Hz - 5...5 % |
| Network frequency | 47.5...63 Hz |
| EMC filter | Without EMC filter |
| Line current | 17.3 A 240 V 20.8 A 200 V |

Complementary

| | |
|----------------------------------|---|
| Apparent power | 9.2 kVA 240 V |
| Prospective line I _{sc} | 22 kA |
| Continuous output current | 24.2 A 230 V |
| Maximum transient current | 26.6 A 60 s |
| Speed drive output frequency | 0.5...200 Hz |
| Nominal switching frequency | 12 kHz |
| Switching frequency | 12...16 kHz with derating factor 6...16 kHz adjustable |
| Speed range | 1...10 |
| Speed accuracy | +/- 10 % of nominal slip 0.2 T _n to T _n |

| | |
|-------------------------------------|--|
| Torque accuracy | +/- 15 % |
| Transient overtorque | 120 % of nominal motor torque +/- 10 % 60 s |
| Asynchronous motor control profile | Flux vector control without sensor, standard Voltage/Frequency ratio, 5 points Voltage/Frequency ratio - Energy Saving, quadratic U/f Voltage/Frequency ratio, 2 points Voltage/Frequency ratio, automatic IR compensation (U/f + automatic U ₀) |
| Regulation loop | Adjustable PI regulator |
| Motor slip compensation | Not available in voltage/frequency ratio motor control Automatic whatever the load Adjustable |
| Local signalling | 1 LED red DC bus energized |
| Output voltage | <= power supply voltage |
| Isolation | Electrical between power and control |
| Type of cable | IEC cable without mounting kit 1 45 °C copper 90 °C XLPE/EPR IEC cable without mounting kit 1 45 °C copper 70 °C PVC UL 508 cable with UL Type 1 kit 3 40 °C copper 75 °C PVC |
| Electrical connection | Terminal 2.5 mm ² AWG 14 VIA, VIB, FM, FLA, FLB, FLC, RY, RC, F, R, RES Terminal 16 mm ² AWG 6 L1/R, L2/S, L3/T |
| Tightening torque | 2.5 N.m 22 lb.in L1/R, L2/S, L3/T 0.6 N.m VIA, VIB, FM, FLA, FLB, FLC, RY, RC, F, R, RES |
| Supply | Internal supply for reference potentiometer (1 to 10 kOhm) 10.5 V DC +/- 5 % <= 10 A overload and short-circuit protection Internal supply 24 V DC 21...27 V <= 200 A overload and short-circuit protection |
| Analogue input number | 2 |
| Analogue input type | Switch-configurable voltage VIA 0...10 V DC 24 V max 30000 Ohm 10 bits Configurable voltage VIB 0...10 V DC 24 V max 30000 Ohm 10 bits Configurable PTC probe VIB 0...6 probes 1500 Ohm Switch-configurable current VIA 0...20 mA 250 Ohm 10 bits |
| Sampling duration | 2 ms +/- 0.5 ms F discrete 2 ms +/- 0.5 ms R discrete 2 ms +/- 0.5 ms RES discrete 3.5 ms +/- 0.5 ms VIA analog 22 ms +/- 0.5 ms VIB analog |
| Response time | 2 ms +/- 0.5 ms FM analog 7 ms +/- 0.5 ms FLA, FLC discrete 7 ms +/- 0.5 ms FLB, FLC discrete 7 ms +/- 0.5 ms RY, RC discrete |
| Accuracy | +/- 0.6 % VIA for a temperature variation 60 °C +/- 0.6 % VIB for a temperature variation 60 °C +/- 1 % FM for a temperature variation 60 °C |
| Linearity error | +/- 0.15 % of maximum value input VIA +/- 0.15 % of maximum value input VIB +/- 0.2 % output FM |
| Analogue output number | 1 |
| Analogue output type | Switch-configurable voltage FM 0...10 V DC 7620 Ohm 10 bits Switch-configurable current FM 0...20 mA 970 Ohm 10 bits |
| Discrete output number | 2 |
| Discrete output type | Configurable relay logic FLA, FLC NO 100000 cycles Configurable relay logic FLB, FLC NC 100000 cycles Configurable relay logic RY, RC NO 100000 cycles |
| Minimum switching current | 3 mA 24 V DC configurable relay logic |
| Maximum switching current | 5 A 250 V AC resistive cos phi = 1 L/R = 0 ms FL, R 5 A 30 V DC resistive cos phi = 1 L/R = 0 ms FL, R 2 A 250 V AC inductive cos phi = 0.4 L/R = 7 ms FL, R 2 A 30 V DC inductive cos phi = 0.4 L/R = 7 ms FL, R |
| Discrete input type | Programmable F 24 V DC level 1 PLC 4700 Ohm Programmable R 24 V DC level 1 PLC 4700 Ohm Programmable RES 24 V DC level 1 PLC 4700 Ohm |
| Discrete input logic | Positive logic (source) F, R, RES <= 5 V >= 11 V Negative logic (sink) F, R, RES >= 16 V <= 10 V |
| Acceleration and deceleration ramps | Linear adjustable separately from 0.01 to 3200 s Automatic based on the load |
| Braking to standstill | By DC injection |

| | |
|--|---|
| Protection type | Motor phase break motor Break on the control circuit drive Thermal power stage drive Overvoltages on the DC bus drive Against exceeding limit speed drive Against input phase loss drive With PTC probes motor Input phase breaks drive Line supply overvoltage and undervoltage drive Line supply undervoltage drive Overcurrent between output phases and earth drive Overheating protection drive Short-circuit between motor phases drive Thermal protection motor |
| Dielectric strength | 2830 V DC between earth and power terminals 4230 V DC between control and power terminals |
| Insulation resistance | >= 1 MOhm 500 V DC for 1 minute |
| Frequency resolution | 0.024/50 Hz analog input 0.1 Hz display unit |
| Communication port protocol | BACnet METASYS N2 APOGEE FLN LonWorks Modbus |
| Connector type | 1 RJ45 1 open style |
| Physical interface | 2-wire RS 485 |
| Transmission frame | RTU |
| Transmission rate | 9600 bps or 19200 bps |
| Data format | 8 bits, 1 stop, odd even or no configurable parity |
| Type of polarization | No impedance |
| Number of addresses | 1...247 |
| Communication service | Read holding registers (03) 2 words maximum Monitoring inhibitible Write multiple registers (16) 2 words maximum Write single register (06) Read device identification (43) Time out setting from 0.1 to 100 s |
| Option card | Communication card LonWorks |
| Operating position | Vertical +/- 10 degree |
| Width | 180 mm |
| Height | 232 mm |
| Depth | 170 mm |
| Product weight | 6.1 kg |
| Power dissipation in W | 249 W |
| Air flow | 85 m3/h |
| Specific application | HVAC |
| IP degree of protection | IP21 |
| Variable speed drive application selection | Building - HVAC : compressor for scroll Building - HVAC : fan Building - HVAC : pump |
| Motor power range AC-3 | 4...6 kW at 200...240 V 3 phases |
| Motor starter type | Variable speed drive |

Environment

| | |
|-------------------------------|---|
| Electromagnetic compatibility | Conducted radio-frequency immunity test level 3 IEC 61000-4-6 Voltage dips and interruptions immunity test IEC 61000-4-11 1.2/50 µs - 8/20 µs surge immunity test level 3 IEC 61000-4-5 Electrical fast transient/burst immunity test level 4 IEC 61000-4-4 Electrostatic discharge immunity test level 3 IEC 61000-4-2 Radiated radio-frequency electromagnetic field immunity test level 3 IEC 61000-4-3 |
| Pollution degree | 3 IEC 61800-5-1 |

| | |
|---------------------------------------|---|
| IP degree of protection | IP20 on upper part without blanking plate on cover EN/IEC 61800-5-1 IP20 on upper part without blanking plate on cover EN/IEC 60529 IP21 EN/IEC 61800-5-1 IP21 EN/IEC 60529 IP41 on upper part EN/IEC 61800-5-1 IP41 on upper part EN/IEC 60529 |
| Vibration resistance | 1 gn 13...200 Hz EN/IEC 60068-2-8 1.5 mm 3...13 Hz EN/IEC 60068-2-6 |
| Shock resistance | 15 gn 11 ms IEC 60068-2-27 |
| Environmental characteristic | Classes 3C1 IEC 60721-3-3 Classes 3S2 IEC 60721-3-3 |
| Noise level | 51 dB 86/188/EEC |
| Operating altitude | 1000...3000 m limited to 2000 m for the Corner Grounded distribution network with current derating 1 % per 100 m <= 1000 m without derating |
| Relative humidity | 5...95 % without condensation IEC 60068-2-3 5...95 % without dripping water IEC 60068-2-3 |
| Ambient air temperature for operation | -10...40 °C without derating > 40...50 °C with derating factor |
| Ambient air temperature for storage | -25...70 °C |
| Standards | EN 61800-3 environments 1 category C2 EN 61800-3 environments 1 category C1 IEC 61800-3 environments 2 category C1 IEC 61800-3 environments 2 category C2 EN 61800-3 environments 2 category C1 EN 61800-3 environments 2 category C3 EN 61800-3 IEC 61800-3 environments 1 category C2 UL Type 1 IEC 61800-3 environments 2 category C3 EN 61800-5-1 IEC 61800-3 IEC 61800-5-1 IEC 61800-3 environments 1 category C1 IEC 61800-3 environments 1 category C3 EN 61800-3 environments 1 category C3 EN 61800-3 environments 2 category C2 |
| Product certifications | UL C-Tick CSA NOM 117 |
| Marking | CE |

Offer Sustainability

| | |
|----------------------------------|---|
| Sustainable offer status | Green Premium product |
| RoHS (date code: YYWW) | Compliant - since 1101 - Schneider Electric declaration of conformity Schneider Electric declaration of conformity |
| REACH | Reference contains SVHC above the threshold - Go to CaP for more details Go to CaP for more details |
| Product environmental profile | Available Product environmental |
| Product end of life instructions | Available Product environmental |

Contractual warranty

| | |
|-----------------|-----------|
| Warranty period | 18 months |
|-----------------|-----------|

Mounting Recommendations

Clearance

Depending on the conditions in which the drive is to be used, its installation will require certain precautions and the use of appropriate accessories.

Install the unit vertically:

- Do not place it close to heating elements.
- Leave sufficient free space to ensure that the air required for cooling purposes can circulate from bottom to the top of the unit.

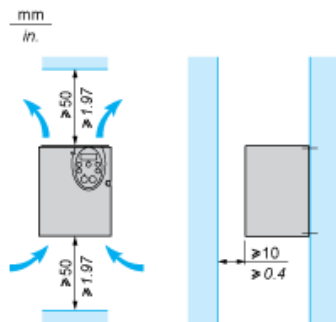

Mounting Types

Type A mounting

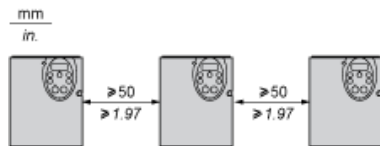

Type B mounting

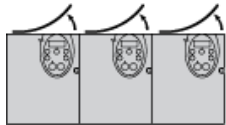

Type C mounting

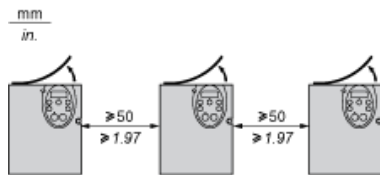

By removing the protective blanking cover from the top of the drive, the degree of protection for the drive becomes IP21. The protective blanking cover may vary according to the drive model, see opposite.

Specific Recommendations for Mounting in an Enclosure

To help ensure proper air circulation in the drive:

- Fit ventilation grilles.
- Check that there is sufficient ventilation. If there is not, install a forced ventilation unit with a filter. The openings and/or fans must provide a flow rate at least equal to the drive's heat dissipation.
- Use special filters with UL Type 12/IP54 protection.
- Remove the blanking cover from the top of the drive.

Sealed Metal Enclosure (IP54 Degree of Protection)

The drive must be mounted in a dust and damp proof enclosure in certain environmental conditions, such as dust, corrosive gases, high humidity with risk of condensation and dripping water, splashing liquid, etc. This enables the drive to be used in an enclosure where the maximum internal temperature reaches 50°C.

Recommended Wiring Diagram

3-Phase Power Supply

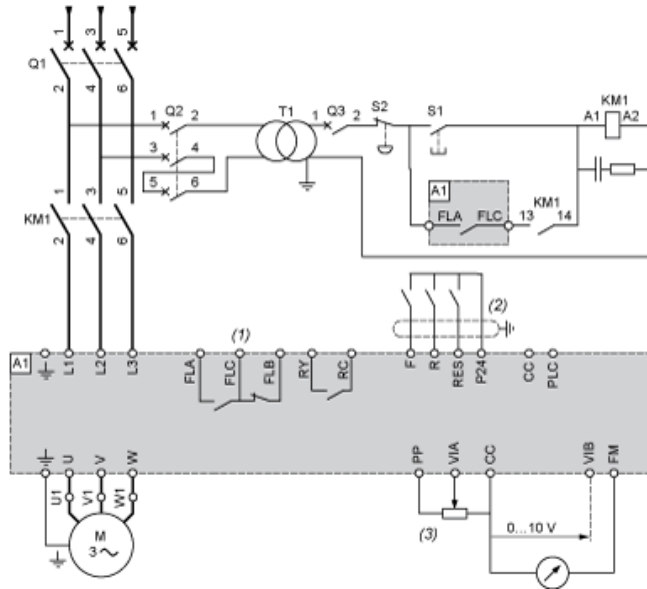

A1: ATV 212 drive

KM1: Contactor

Q1: Circuit breaker

Q2: GV2 L rated at twice the nominal primary current of T1

Q3: GB2CB05

S1, S2: XB4 B or XB5 A pushbuttons

T1: 100 VA transformer 220 V secondary

(1) Fault relay contacts for remote signalling of the drive status

(2) Connection of the common for the logic inputs depends on the positioning of the switch (Source, PLC, Sink)

(3) Reference potentiometer SZ1RV1202

All terminals are located at the bottom of the drive. Install interference suppressors on all inductive circuits near the drive or connected on the same circuit, such as relays, contactors, solenoid valves, fluorescent lighting, etc.

Switches (Factory Settings)

Voltage/current selection for analog I/O (VIA and VIB)



Voltage/current selection for analog I/O (FM)



Selection of logic type

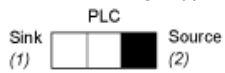

(1) negative logic

(2) positive logic

Other Possible Wiring Diagrams

Logic Inputs According to the Position of the Logic Type Switch

“Source” position

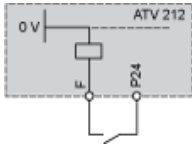

“Sink” position

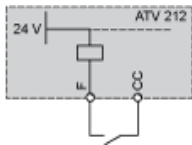

“PLC” position with PLC transistor outputs

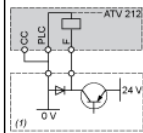

(1) PLC

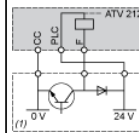

(1) PLC

2-wire control

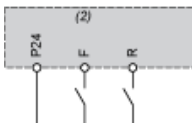

F: Forward
R: Preset speed
(2) ATV 212 control terminals

3-wire control

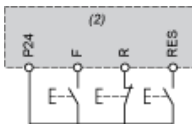

F: Forward
R: Stop
RES: Reverse
(2) ATV 212 control terminals

PTC probe

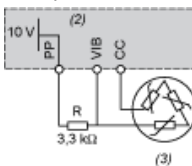

(2) ATV 212 control terminals
(3) Motor

Analogue Inputs

Voltage analog inputs

External +10 V



Analogue input configured for current: 0-20 mA, 4-20 mA, X-Y mA

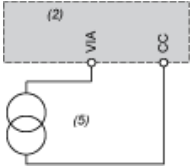

- (2) ATV 212 control terminals
- (5) Source 0-20 mA, 4-20 mA, X-Y mA

Analogue input VIA configured as positive logic input ("Source" position)



- (2) ATV 212 control terminals

Analogue input VIA configured as negative logic input ("Sink" position)

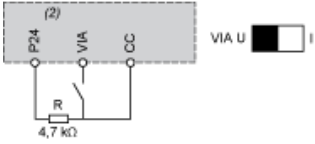

- (2) ATV 212 control terminals

Derating Curves

The derating curves for the drive nominal current (I_n) depend on the temperature, the switching frequency and the mounting type (A, B or C). For intermediate temperatures (45°C for example), interpolate between 2 curves.

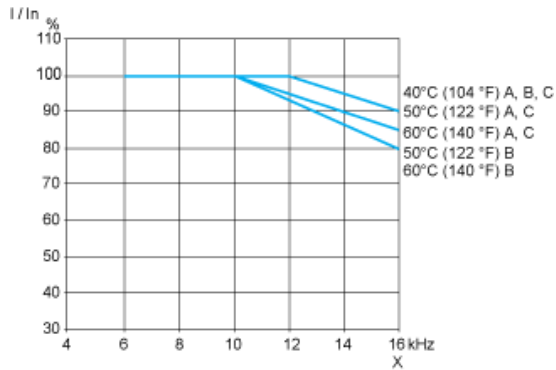

X Switching frequency

<!-- File : MPC-ATV212HU55M3X-BOM.xml , Range ID : 60162, Reference ID :
ATV212HU55M3X -->

Our Proposal: Circuit Breaker + Contactor + Drive for Motor Power 5,5 kW and 200 VAC

<!-- DataBOM 1 Template BEGIN -->

| Motor Power (kW) | Icu (kA) | Breaker | Contactor (*) | Motor Starter |
|------------------|----------|---|---|--|
| 5.5 | 50 |  GV2L22 |  LC1D09P7 |  ATV212HU55M3X |

Non contractual pictures.

<!-- DataBOM 1 Template END --> <!-- Templates For Variants BEGIN -->

(*) You can select the contactor proposed or variants. Please consider examples hereafter or follow the link to the complete offer.

<!-- VARIANT 1 -->

| Motor Power kW | Coil voltage VAC - 50/60 Hz | 24 | 48 | 110 | 115 | 220 | 230 | 400 | Other |
|----------------|-----------------------------|----|----|-----|-----|-----|-----|-----|----------------|
| 5.5 | LC1D09 .. | - | E7 | F7 | FE7 | M7 | P7 | V7 | Complete Offer |

<!-- VARIANT 1 END --> <!-- VARIANT 2 -->

| Motor Power kW | Coil voltage VDC - U 0.75...1.25 Uc | 24 | 48 | Other |
|----------------|-------------------------------------|----|----|----------------|
| 5.5 | LC1D09 .. | BD | ED | Complete Offer |

<!-- VARIANT 2 END --> <!-- VARIANT 3 -->

| Motor Power kW | Coil voltage Low Consumption VDC - U 0.8...1.25 Uc | 24 | 110 | Other |
|----------------|--|----|-----|----------------|
| 5.5 | LC1D09 .. | BL | FL | Complete Offer |

<!-- VARIANT 3 END --> <!-- Templates For Variants END -->