

WAGOBX XL

Part No. 60339091

Installation Instructions

For BS En 60670-22 Accessory
(see overleaf for Maintenance Free installation.)

The WAGOBX XL is simple to install just follow these steps:

1. Decide on the arrangement of connectors for the circuit to be installed using either the left or right side of the WAGOBX XL. In this example the right side is being used to connect a switch to a lighting circuit.

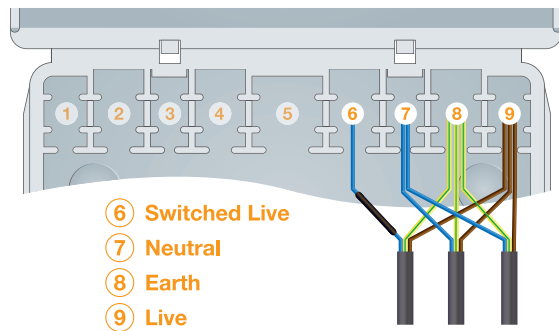

2. Prepare the cables by stripping back 70 - 80mm of the outer sheath.

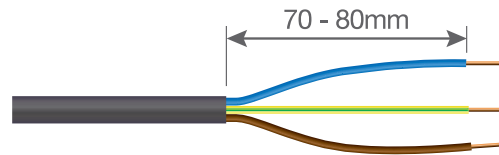

3. Select the appropriate 2273 or 221 series connectors for the circuit.

4. Connect up the circuit:

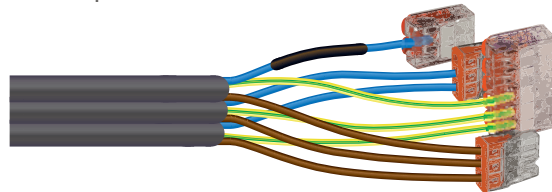

5. If there are cross connections between the two sides of the WAGOBX XL these connections should be made before the connectors are slid into place. These consist of single core wires cut to length.

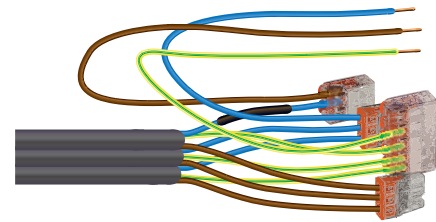

6. Next set up the cable grippers to suit the cable diameter. The grippers are designed to work with cable diameters between 3mm and 15.5mm. There are 6 gripper positions available, with each position altering the clamp diameter by +/- 2.5mm.

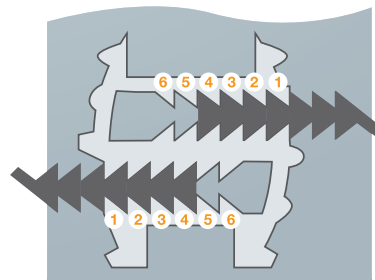

Typical gripper selections:

Position	Cable Diameter
1	3mm
2	5.5mm
3	8mm
4	10.5mm
5	13mm
6	15.5mm

7. Note: It is possible to install cables of different sizes into the same gripper. Cut the gripper along the flat section into two or three parts depending on the different sizes being fitted. We suggest keeping similar cable sizes together in the same slot.

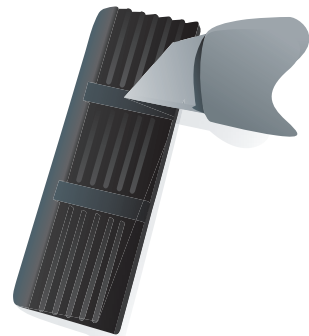

8. Install the largest cable at the bottom of the gripper slot first. Then the next size on top and the smallest last. Fit the gripper first, then each section of cable in turn to prevent the cables moving up the gripper slot.

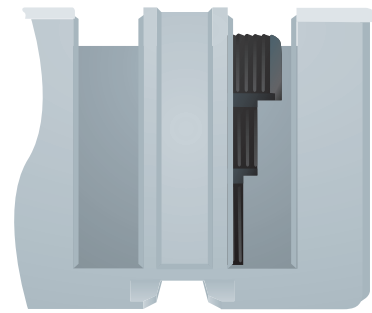

9. Where cables are the same diameter, put the grippers into place first, then put the connectors in position leaving the cables projecting out of the enclosure.

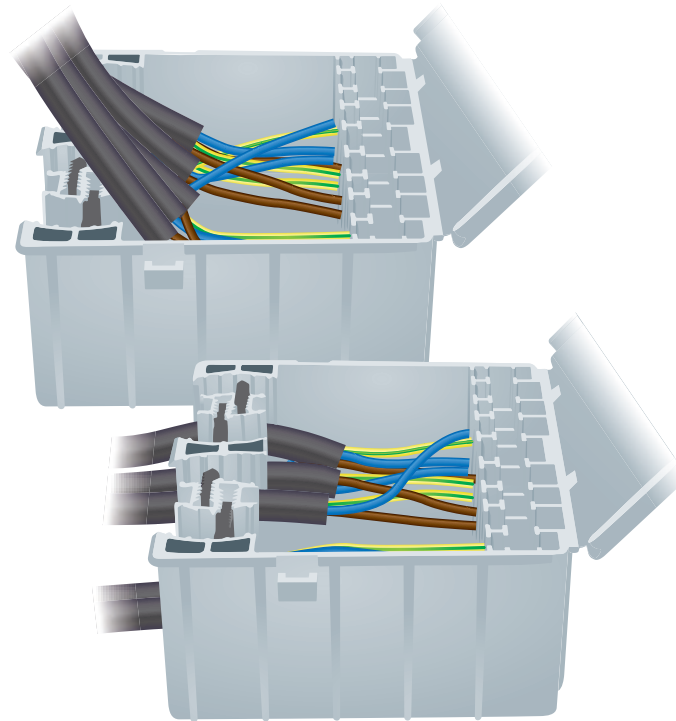

10. Then simply slide the cables down into the gripper slots.

11. Repeat installation process for left hand side of the WAGOBX XL. The example below illustrates how the WAGOBX XL can be used to connect a switching circuit (right side) to four light fittings (left side).

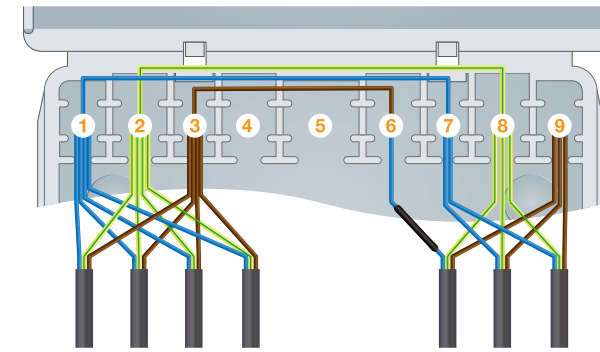

12. Once cable installation is complete, the WAGOBX XL lid can be closed and secured using the cable-tie locking points.

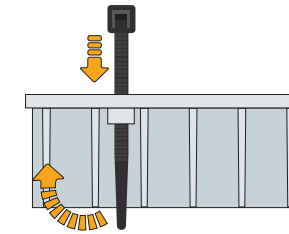

13. If required the WAGOBX can be fixed to a surface using the fixing button feature. Simply fix the button in the required position and slide the WAGOBX into place using one or both of the fixing slots in the base.

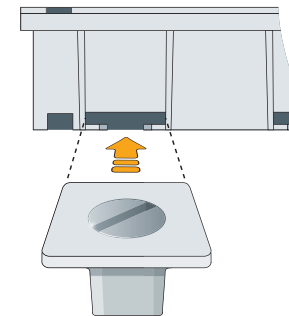

WAGO Limited

Tel: 01788 568 008 Fax: 01788 568 050
info@wago.ltd.uk www.wago.ltd.uk

WAGO is a registered trademark of WAGO Verwaltungsgesellschaft mbH.

WAGOBX XL A Junction Box Innovation

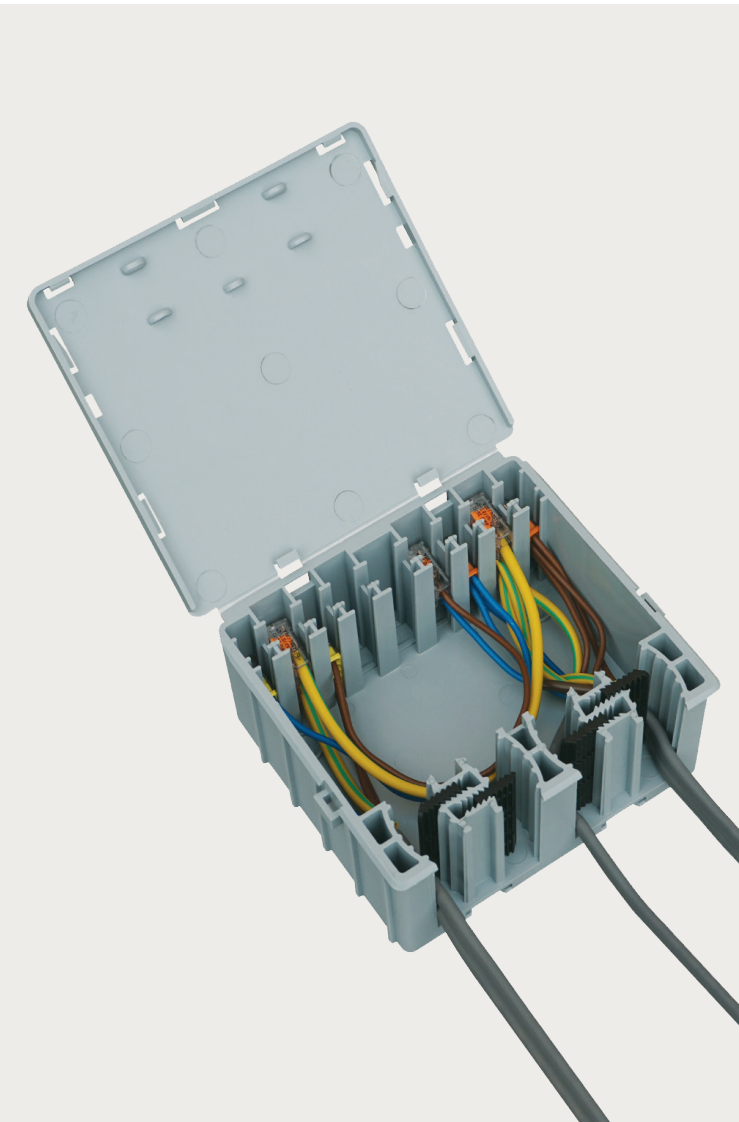

WAGOBOX XL

Connectors

The WAGOBOX XL general purpose electrical enclosure is designed to be used with the WAGO 221 and 2273 series connectors.



221 Series	2273 Series
Compact Lever Connectors	PUSH WIRE® Connectors
Conductor sizes: 0.2 - 4mm ² solid/stranded 0.14 - 4mm ² fine stranded	Conductor sizes: 0.5 - 2.5mm ² solid
Current rating: 32A	Current rating: 24A
Voltage rating: 450V/4kV	Voltage rating: 450V/kV

Overview

The WAGOBOX XL is rated up to 450V and can support conductor sizes from 0.14mm² to 4mm².

The maximum permitted number of separately supplied individual circuits is 2.

The maximum number of individual conductor connections is 36, based on the installation of twelve 3-core cables of 1mm².

The maximum number of 4mm² connections is 24, based on installation of six 4-core cables.

The cable clamps can grip up to 12 cables with an overall diameter between 3mm and 15mm.



Familiarisation

1. **The internal layout of the WAGOBOX XL** can be considered as two halves, a left and right side with a larger central connector receptacle between the two.

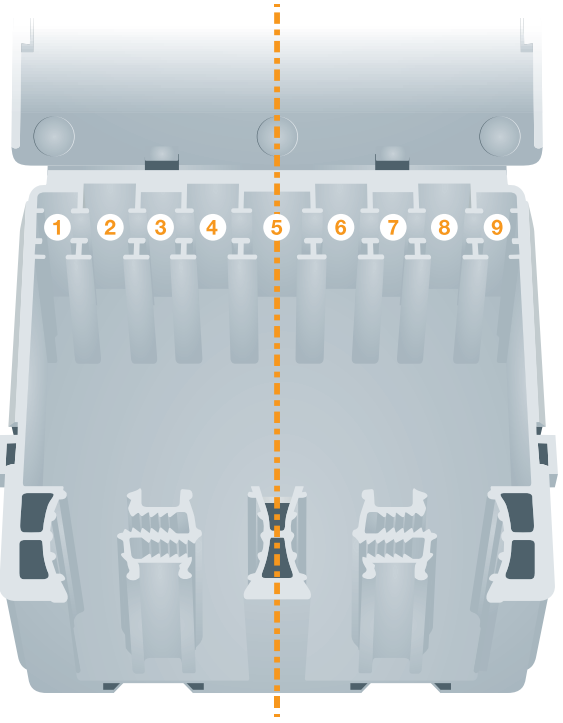

2. There are nine connector receptacles inside the WAGOBOX XL. The centre receptacle (5) is designed to fit the 221 & 2273-108 connectors. This connector can connect 8 wires together or a pair can be joined to provide a 14 way terminal block. It is expected that this connector position is used to connect earth wires when 8 or more cables on a single circuit are installed.

3. Both the left and right side of the WAGOBOX XL have 2 slots for 2273 connectors (numbered 1, 3, 7 & 9) and 2 slots for 221 connectors (numbered 2, 4, 6 & 8).

4. The WAGOBOX XL is designed to support either one or two circuits that can be supplied together or separately. It is important to ensure that this is indicated on the lid using permanent marker or labels.



5. When two separate circuits are being supported no connections between the left and right side are permitted. Each side must be dedicated to one circuit only.

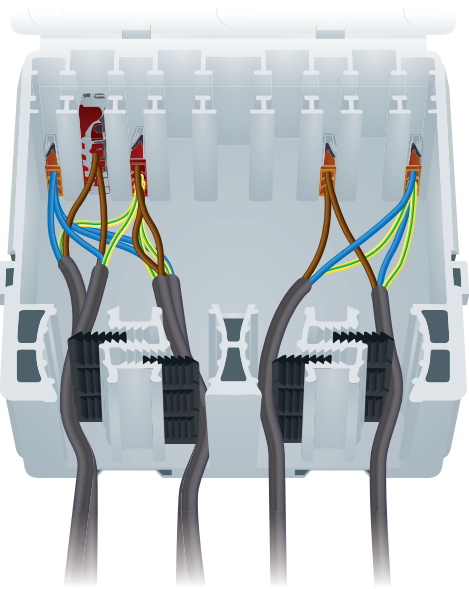

When a single circuit is being supported then cross linking between each side of the enclosure is permitted.

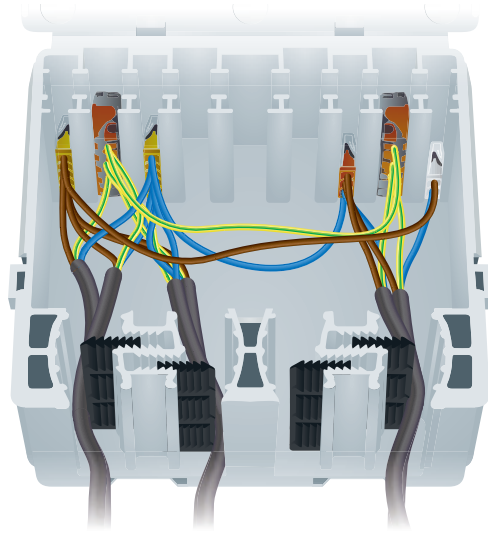

6. When a large number of cables need to be connected on a single circuit then the central receptacle can be used to connect the cable earth wires together using the 2273-108 PUSH-WIRE® connectors and jumper bar 862-482.

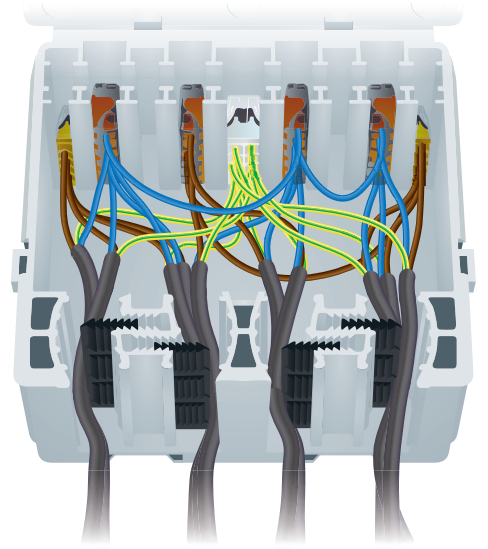

Maintenance Free Installation Instructions

Instructions for BS 5733-MF Accessory

In situations where you need to install a WAGOBOX XL in an inaccessible location then the following instructions must be followed. This will ensure your completed accessory complies with the requirements of BS 5733 for a maintenance free accessory.

1. Only WAGO **2273 or 221 series** connectors are permitted for use with a WAGOBOX XL in maintenance free locations.
2. BS 5733 only permits **single circuits** to be terminated into a maintenance free accessory.
3. Apply BS 5733 Rating Requirements. Please note the terminal ratings in the table below are different to the published ratings. These terminal ratings must be used when selecting appropriate terminals to assemble a BS 5733 maintenance free accessory.

Part No.s	Max. Current Rating	Max. Cable csa mm ²	Single Side Max. Aggregate Current (I _{ag})
2273-102 2273-103 2273-104 2273-105 2273-108	20A	2.5	50A
221-412 221-413 221-415	20A	4	50A

The Single Side Max Aggregate current (I_{ag}) is the sum of all the possible currents through either the left or right side of the WAGOBOX XL in normal use. This limit must not be exceeded. Usually the max I_{ag} equals the number of phase terminals multiplied by the rating of the Overcurrent Protective Device for the circuit. There are some exceptions to this rule so if you are in anyway unsure how to calculate the maximum I_{ag} please consult a qualified electrician or contact Connexbox Ltd for support.

4. Follow the BS EN 60670-22 installation instructions ensuring all the phase terminals are neatly fitted into the receptacles in the WAGOBOX XL.
5. Secure the WAGOBOX XL lid using the cable-tie locking points.