



CY3686

EZ-USB[®] NX2LP-Flex[™]
Development Kit Guide

Doc. # 001-61287 Rev. *A

Cypress Semiconductor
198 Champion Court
San Jose, CA 95134-1709
Phone (USA): 800.858.1810
Phone (Intl): 408.943.2600
<http://www.cypress.com>

Copyrights

© Cypress Semiconductor Corporation, 2010-2012. The information contained herein is subject to change without notice. Cypress Semiconductor Corporation assumes no responsibility for the use of any circuitry other than circuitry embodied in a Cypress product. Nor does it convey or imply any license under patent or other rights. Cypress products are not warranted nor intended to be used for medical, life support, life saving, critical control or safety applications, unless pursuant to an express written agreement with Cypress. Furthermore, Cypress does not authorize its products for use as critical components in life-support systems where a malfunction or failure may reasonably be expected to result in significant injury to the user. The inclusion of Cypress products in life-support systems application implies that the manufacturer assumes all risk of such use and in doing so indemnifies Cypress against all charges.

Any Source Code (software and/or firmware) is owned by Cypress Semiconductor Corporation (Cypress) and is protected by and subject to worldwide patent protection (United States and foreign), United States copyright laws and international treaty provisions. Cypress hereby grants to licensee a personal, non-exclusive, non-transferable license to copy, use, modify, create derivative works of, and compile the Cypress Source Code and derivative works for the sole purpose of creating custom software and or firmware in support of licensee product to be used only in conjunction with a Cypress integrated circuit as specified in the applicable agreement. Any reproduction, modification, translation, compilation, or representation of this Source Code except as specified above is prohibited without the express written permission of Cypress.

Disclaimer: CYPRESS MAKES NO WARRANTY OF ANY KIND, EXPRESS OR IMPLIED, WITH REGARD TO THIS MATERIAL, INCLUDING, BUT NOT LIMITED TO, THE IMPLIED WARRANTIES OF MERCHANTABILITY AND FITNESS FOR A PARTICULAR PURPOSE. Cypress reserves the right to make changes without further notice to the materials described herein. Cypress does not assume any liability arising out of the application or use of any product or circuit described herein. Cypress does not authorize its products for use as critical components in life-support systems where a malfunction or failure may reasonably be expected to result in significant injury to the user. The inclusion of Cypress' product in a life-support systems application implies that the manufacturer assumes all risk of such use and in doing so indemnifies Cypress against all charges.

Use may be limited by and subject to the applicable Cypress software license agreement.

NX2LP is a trademark and EZ-USB is a registered trademark of Cypress Semiconductor Corp. All other trademarks or registered trademarks referenced herein are property of the respective corporations.

Flash Code Protection

Cypress products meet the specifications contained in their particular Cypress PSoC Data Sheets. Cypress believes that its family of PSoC products is one of the most secure families of its kind on the market today, regardless of how they are used. There may be methods, unknown to Cypress, that can breach the code protection features. Any of these methods, to our knowledge, would be dishonest and possibly illegal. Neither Cypress nor any other semiconductor manufacturer can guarantee the security of their code. Code protection does not mean that we are guaranteeing the product as 'unbreakable'.

Cypress is willing to work with the customer who is concerned about the integrity of their code. Code protection is constantly evolving. We at Cypress are committed to continuously improving the code protection features of our products.

Contents



1. Introduction	5
1.1 CY3686 EZ-USB NX2LP-Flex DVK Features	5
1.2 CY3686 EZ-USB NX2LP-Flex DVK Contents	6
1.3 System Requirements	6
1.4 Additional Learning Resources	6
1.5 Technical Support	7
1.6 References	7
1.7 Acronyms	7
1.8 Document History	8
1.9 Documentation Conventions	8
2. Getting Started	9
2.1 Kit Installation	9
2.2 Installing the CY3686 DVK Device Drivers	14
2.2.1 Driver Installation	16
3. Kit Operation	21
3.1 Quick Start	21
3.2 Board Configuration	21
3.3 NX2LP Utilities	24
3.3.1 CyConsole Utility	24
3.3.2 NAND FW Packaging Utility	27
3.3.3 NAND Programming Utility	27
3.4 Debugging using Keil uVision	31
4. Hardware	37
4.1 Overview	37
4.1.1 FX2LP Base Board	37
4.1.2 FX2LP Prototyping Board	39
4.1.3 The NX2LP Flex Board	40
4.2 NX2LP Flex Board Details	42
4.2.1 Jumper Settings and Switch Configurations	42
4.2.2 NX2LP-Flex Board Header Configurations	44
4.2.3 NX2LP-Flex Board Hardware Configuration	45
5. NAND Manufacturing Utility	47
5.1 Operation Overview	47
5.2 Vendor Parameters	48
5.3 Options Menu	49
5.4 Device Menu	51
5.5 CTRL Key Commands	52
5.6 Programming Devices	52

5.7	Reprogramming Devices	54
5.8	Support for NAND Parts	55
Appendix		57
	Firmware Design Notes	57
A.2	USB Mass Storage Testing	57
	Handling SOP Sockets	57
	DVK Board Schematics	59
	DVK Board Layout	61
	Frequently Asked Questions.....	64

1. Introduction



The Cypress Semiconductor EZ-USB[®] NX2LP-Flex[™] Controller chip (CY7C68033) is a programmable USB NAND controller based on the FX2LP (CY7C68013A) silicon. The NX2LP-Flex architecture enables USB data transfer rates of over 53 MB for every second. This is the maximum allowable USB 2.0 bandwidth, while still using a low-cost 8051 microcontroller in a small 56-pin QFN package. While both CY7C68033 and CY7C68034 are functionally similar, the latter is more appropriate for battery-powered applications because of its low standby power consumption.

The CY3686 EZ-USB NX2LP-Flex Development Kit (DVK) is provided to customers for evaluating and developing NAND Flash USB mass storage applications using the NX2LP-Flex controller. The CY3686 NX2LP-Flex DVK is a combination of two development platforms:

- The **CY3684** EZ-USB FX2LP-DVK, based on Cypress's most popular USB 2.0 general purpose microcontroller, the EZ-USB FX2LP
- The NX2LP-Flex development board, based on Cypress's NAND flash controller EZ-USB NX2LP-Flex

This enables users to integrate their custom application with NAND flash solutions.

This chapter gives an overview of the DVK. Chapter 2 describes the installation of the CY3686 NX2LP-Flex DVK kit and drivers. Chapter 3 describes the utilities provided with the kit and firmware debugging with Keil uVision. Chapter 4 describes the kit hardware. Chapter 5 describes the NX2LP NAND Programming utility. The Appendix chapter describes firmware design notes, USB Mass Storage testing, handling SOP sockets, schematics and layout, and frequently asked questions associated with the CY3686 NX2LP-Flex DVK.

1.1 CY3686 EZ-USB NX2LP-Flex DVK Features

This kit provides:

- NAND flash firmware source code with the following features:
 - 512-page, 2K-page, and 4K-page NAND type support
 - Composite device class (that is, USB Mass Storage Class combined with HID Class)
 - Removable/unremovable device configuration
 - USB BULK only mass storage device class support
 - Windows boot support
 - Autorun support
 - 2-NAND chips select and 8-NAND chips select support
- The CY3686 EZ-USB NX2LP-Flex DVK debugging platform, which includes:
 - C-level single-step debugging capability with breakpoints using the FX2LP base board
 - NAND flash programming tool for developing and manufacturing support
 - Prototyping board for user add-on hardware
 - NX2LP-Flex board with sockets and NAND flash chips
- Basic 4K Keil C Compiler (evaluation compiler for the Cypress EZ-USB family)

- NAND flash manufacturing utility programs
 - NandMfg.exe (NAND flash programming tool)
 - BldNx2.exe (Build configuration file)
- GPIF designer tool
- MAC OS 9.x drivers available at <http://www.cypress.com/?rID=14396>

1.2 CY3686 EZ-USB NX2LP-Flex DVK Contents

The development kit includes:

- EZ-USB advanced development board (FX2LP base board)
- EZ-USB prototyping board ("Breadboard")
- NX2LP-Flex board populated with two NAND flash devices
- USB cable
- RS-232 cable
- CY7C68033 sample chips
- NAND manufacturing utility
- CY3686 firmware and BldNx2 utility
- GPIF Designer
- Kit CD/DVD with documentation

1.3 System Requirements

The CY3686 EZ-USB NX2LP-Flex DVK has the following system requirements:

- Microsoft Windows XP/Windows Vista/Windows 7
- Microsoft .NET Framework v2.0 or later
- Administrative privileges on the system
- 64 MB RAM (256 MB recommended)
- Pentium IV-class PC (1 GHz or higher recommended)
- Super VGA display (resolution 800 × 600 or higher)
- USB Host Controller (full-speed or high-speed)

The NAND development tools (such as, NANDMfg.exe, BldNx2.exe, and so on) are supported on Windows XP, Windows Vista, and Windows 7 and not on Mac or Linux OS. However, after the NAND flash is programmed, the Cypress EZ-USB NX2LP development board and the EZ-USB NX2LP NAND flash Controller operate in a Mac and Linux environment if the OS supports USB mass storage devices.

1.4 Additional Learning Resources

- CY3686 NX2LP Development Kit (<http://www.cypress.com/?rID=14320>)
- NX2LP Compatible NAND list (<http://www.cypress.com/?docID=21757>)
- CY3684 FX2LP Development Kit (<http://www.cypress.com/?rID=14321>)
- USB 2.0 to ATA/CF Reference Design – CY4611B (<http://www.cypress.com/?rID=14406>)
- Interfacing Cypress CY3686 DVK to NAND Flash Memory with Four Chip Selects - AN41299 (<http://www.cypress.com/?rID=12958>)
- Getting Started With NX2LP-Flex™ - AN64408 (<http://www.cypress.com/?rID=46712>)
- NX2LP-Flex™ USB to NAND Flash Firmware Design Notes - AN61347 (<http://www.cypress.com/?rID=43431>)

1.5 Technical Support

For feedback or technical support for the CY3686 EZ-USB NX2LP-Flex DVK, contact Cypress at <http://www.cypress.com> > Technical Support > Create a Case.

1.6 References

- USB Mass Storage Class - Bulk Only Transport, USB Mass Storage DWG. (http://www.usb.org/developers/devclass_docs/usbmassbulk_10.pdf)
- USB Mass Storage Class - Specification Overview, USB Mass Storage DWG (http://www.usb.org/developers/devclass_docs/Mass_Storage_Specification_Overview_v1.4_2-19-2010.pdf)
- USB Specification - Revision 2.0, USB Implementers Forum. (<http://www.usb.org/developers/docs>)
- EZ-USB Technical Reference Manual for FX2LP, Revision 1.2, Cypress (<http://www.cypress.com/?riD=38232>)
- NX2LP-Flex data sheet (<http://www.cypress.com/?riD=14187>)
- SCSI-3 Specification (<http://t10.org/scsi-3.htm>)

1.7 Acronyms

Acronym	Description
2K-NAND	Nand flash with page size = 2112
4K-NAND	NAND flash with page size ≥ 4224
512-NAND	NAND flash with page size = 528
CBW	Command block wrapper. A packet containing a command block and associated information.
CSW	Command status wrapper. A packet containing the status of a command block.
ECC	Error correcting code. Logic designed to detect and correct memory errors
GPIO	General purpose I/O
SCSI	Small computer system Interface

1.8 Document History

Revision	PDF Creation Date	Origin of Change	Description of Change
**	05/04/10	SHAH	Initial version of kit guide
*A	08/10/2012	VKKN/NMMA	Updates from review/audit, NAND utility software upgrade

1.9 Documentation Conventions

Table 1-1. Document Conventions for Guides

Convention	Usage
Courier New	Displays file locations, user entered text, and source code: C:\ ...cd\icc\
<i>Italics</i>	Displays file names and reference documentation: Read about the <i>sourcefile.hex</i> file in the <i>PSoC Designer User Guide</i> .
[Bracketed, Bold]	Displays keyboard commands in procedures: [Enter] or [Ctrl] [C]
File > Open	Represents menu paths: File > Open > New Project
Bold	Displays commands, menu paths, and icon names in procedures: Click the File icon and then click Open .
Times New Roman	Displays an equation: $2 + 2 = 4$
Text in gray boxes	Describes cautions or unique functionality of the product.

2. Getting Started



This chapter describes the installation and configuration of the CY3686 EZ-USB NX2LP-Flex DVK.

2.1 Kit Installation

To install the kit software, follow these steps:

1. Insert the kit CD/DVD in the CD/DVD drive of your PC. The CD/DVD is designed to auto-run and the kit installer startup screen appears.
Download the latest kit installer ISO file from <http://www.cypress.com/go/CY3686>. Create an installer CD/DVD or extract the ISO using Winrar and install the executable.
2. Click **Install CY3686 NX2LP-FLEX DVK** to start the installation.

Figure 2-1. Kit Installer Startup Screen



If auto-run does not execute, double-click *cyautorun.exe* in the root directory of the CD/DVD.

Figure 2-2. CD/DVD Root Directory



3. On the startup screen, click **Next** to start the installer.
4. The **InstallShield Wizard** screen appears. Click **Change** to modify the default setup location shown on the InstallShield Wizard screen.
5. Click **Next** to launch the kit installer.

Figure 2-3. InstallShield Wizard



6. In the **Product Installation Overview** screen, select the installation type that best suits your requirement. The drop-down menu has three options: Typical, Complete, and Custom.

Figure 2-4. Installation Type Options

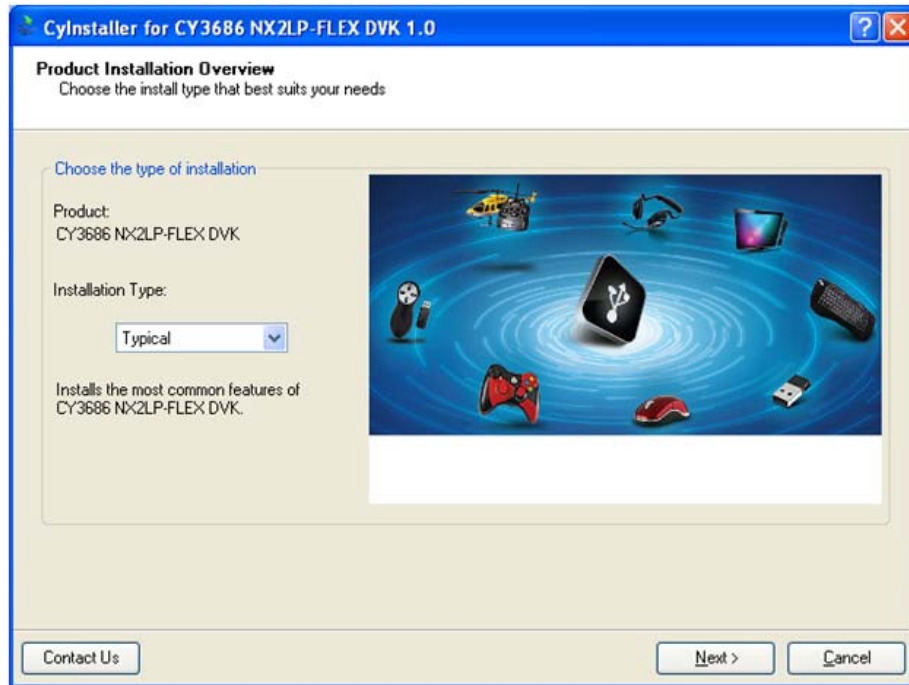

7. Click **Next** to start the installation.
8. Accept the license agreement.

Figure 2-5. License Agreement

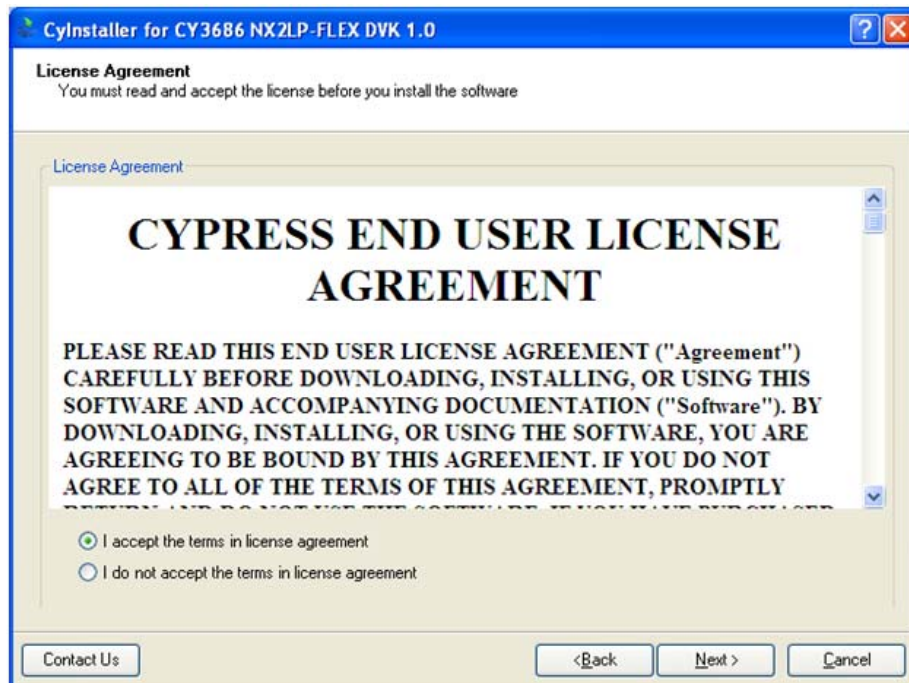

9. When the installation begins, a list of packages appears on the **Installation Page**. A green check mark appears next to every package you download and install.
10. Wait until all the packages are downloaded and installed successfully.

Figure 2-6. Installation Page

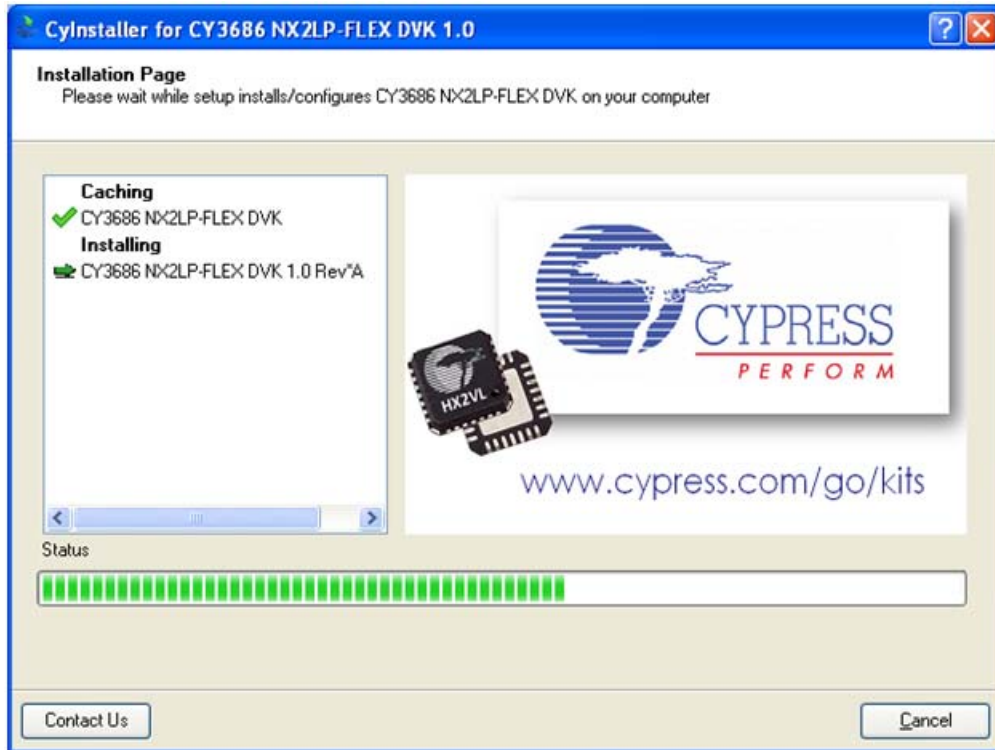

11. The CY3686 kit contains Keil uVision2 evaluation version with a code limit of 4K. The Keil uVision2 Welcome screen pops up. Click **Next**.

Figure 2-7. Keil uVision2 Welcome Screen

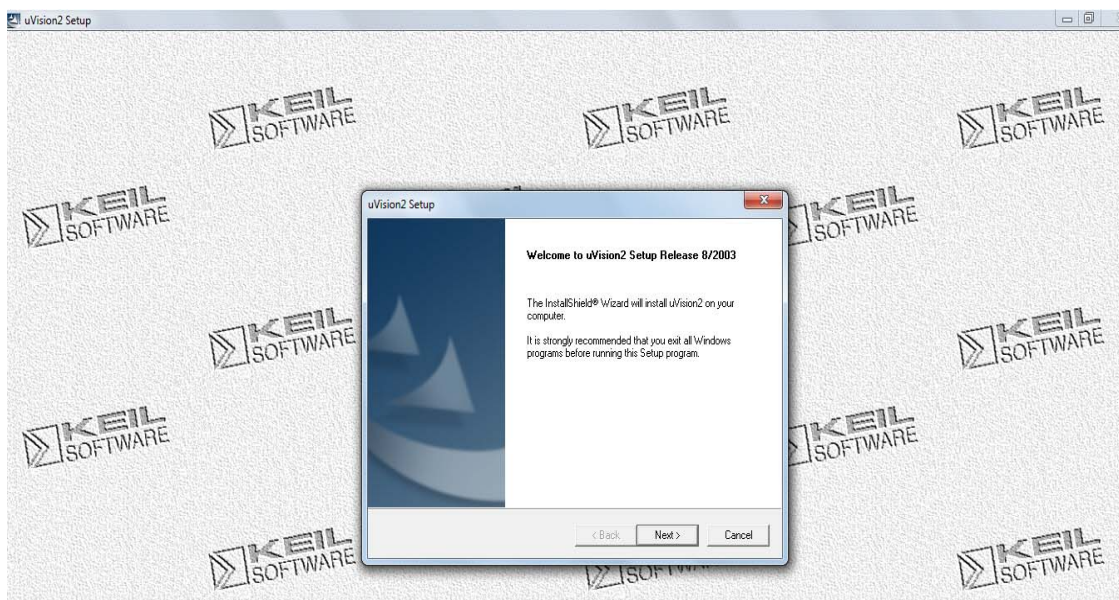

12. In the subsequent windows, select **Next** until the Keil install screen prompts for the 'User Name' and 'Company Name'. Enter the details (the following screenshot has a sample).

Figure 2-8. Customer Information Page

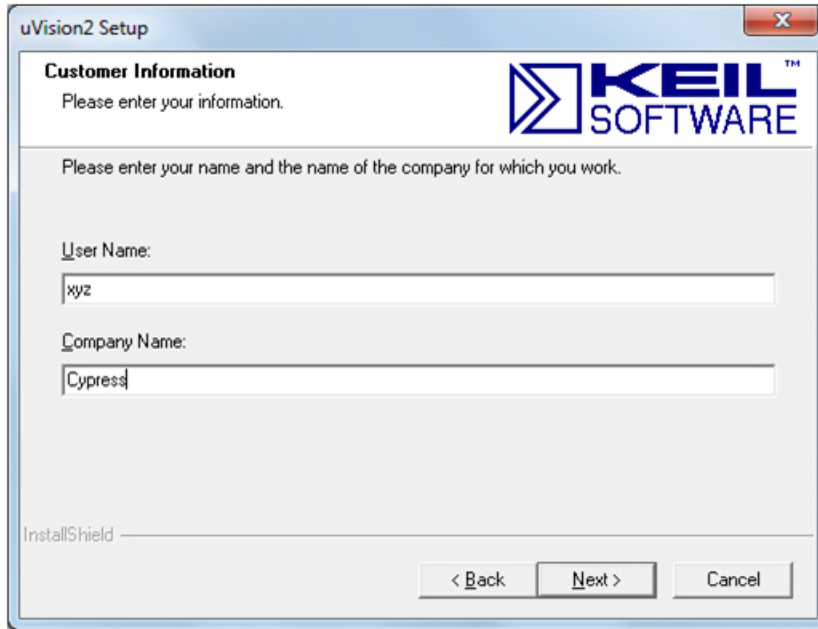

13. In subsequent windows, click **Next** until the Keil Installer displays the **Finish** window. Click on **Finish** to complete the entire Keil uVision2 installation process.

Note The Keil uVision 2 is installed only if it is a fresh install. If it was installed earlier, then only the DVK contents are installed. This is an evaluation version of Keil uVision2 and is only useful for opening the Keil project (CY3686fw.Uv2). To edit and compile the CY3686 NX2LP-Flex firmware source files, purchase a full version of the Keil 8051 software from Keil Software at www.keil.com.

Figure 2-9. Keil Installation Completion Page

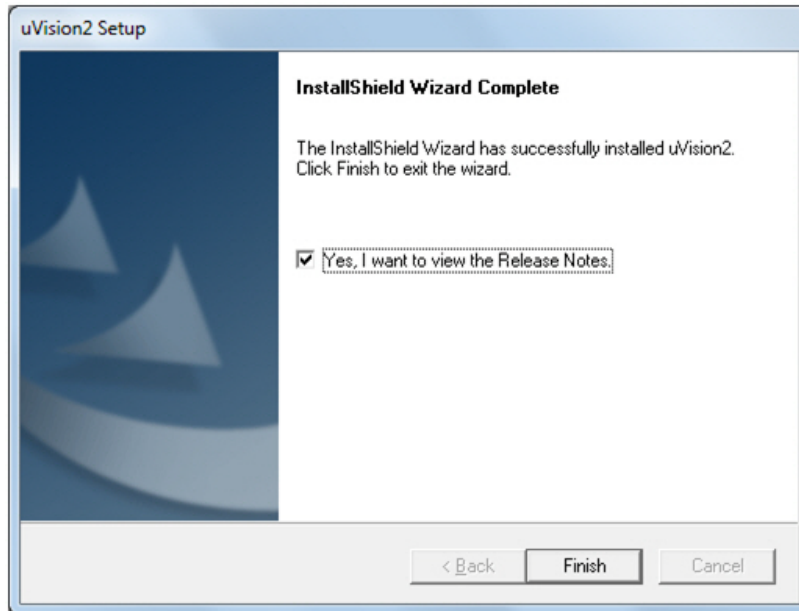

14. Click **Finish** to complete the kit installation.

Figure 2-10. Installation Completion Page



Note Download and install the GPIF designer tool from www.cypress.com/go/CY3686.

2.2 Installing the CY3686 DVK Device Drivers

The FX2LP base board, the prototype board, and the NX2LP-Flex board can be stacked up with different settings to create different configurations as described in section 3.2, [Board Configuration](#). While each of them has different purposes and debug capabilities, only five of them are unique from the host PC's point of view and require installation of drivers when connected to the host for the first time. Following are the five unique settings:

■ Configuration 1

The EEPROM switch settings on the FX2LP base board are as follows:

1. SW1 – Not applicable
2. SW2 – No EEPROM

In this configuration, only the FX2LP board is recognized by the host PC. The device appears as 'Cypress EZ-USB FX2LP No EEPROM (3.4.5.000)' in the Device Manager with VID = 0x04B4 and PID = 0x8613.

■ Configuration 2

The EEPROM switch settings on the FX2LP base board are as follows:

1. SW1 – Large EEPROM (programmed with "loader.iic")
2. SW2 – EEPROM
3. NANDMfg.exe utility is not open

The NX2LP Flex board is set with nothing connected on Pad U1 and U2. The switches and jumpers are left in their default setting. The FX2LP board (with the NX2LP Flex board stacked on top) is connected to the host PC. When there is no NAND flash populated in the NAND sockets or when an unprogrammed NAND part (no NX2LP user firmware image) is mounted on the NAND socket of the NX2LP-Flex board, the device appears as 'Cypress EZ-USB NX2LP-Flex BootLoader(3.4.5.000)' in the Device Manager with VID = 0x04B4 and PID = 0x6823.

■ Configuration 3

The EEPROM switch settings on the FX2LP base board are as follows:

1. SW1 – Large EEPROM (programmed with "loader.iic")
2. SW2 – EEPROM
3. NANDMfg.exe utility is open

The NX2LP Flex board is set with nothing connected on Pad U1 and U2. The switches and jumpers are left in their default setting. The FX2LP board (with the NX2LP Flex board stacked on top) is connected to the host PC. When there is no NAND flash populated in the NAND sockets or when an unprogrammed NAND part (no NX2LP user firmware image) is mounted on the NAND socket of the NX2LP-Flex board, the device appears as 'Cypress EZ-USB NX2LP-Flex Unprogrammed NAND(3.4.5.000)' in the Device Manager with VID = 0x04B4 and PID = 0x4617.

■ Configuration 4

The EEPROM switch settings on the FX2LP base board are as follows:

1. SW1 – Large EEPROM (programmed with "loader.iic")
2. SW2 – EEPROM

The NX2LP Flex board is set with nothing connected on Pad U1 and U2. The switches and jumpers are left in their default setting. The FX2LP board (with the NX2LP Flex board stacked on top) is connected to the host PC. When a NAND flash, programmed with CY3686FW, is mounted on the NAND socket of this board, the device appears as a 'USB Mass Storage Device' in the Device Manager with VID = 0x04B4 and PID = 0XXXXX (enter the PID using the NANDMfg utility while programming). A removable drive appears in **My Computer**.

■ Configuration 5

The EEPROM switch settings on the FX2LP base board are as follows:

1. SW1 – Small EEPROM (programmed with *NX2LP-Small EEPROM.iic*)
2. SW2 – EEPROM

The NX2LP Flex board is set with nothing connected on Pad U1 and U2. The switches and jumpers are left in their default setting. The FX2LP board (with the NX2LP-Flex board stacked on top) is connected to the host PC. The host recognizes the device as 'Cypress EZ-USB FX2LP Board Keil monitor (3.4.5.000)', with VID = 0x04B4 and PID = 0x0082.

2.2.1 Driver Installation

The drivers for the configurations' (mentioned in the previous section) VID/PID are signed by Microsoft. Driver installation is required only the first time. To install the CY3686 NX2LP-Flex DVK driver, follow this procedure:

1. Connect USB A-to-B cable between the PC USB Host controller port and the Type-B connector on the FX2LP base board.
2. The Hardware Update wizard window pops up. Select **No, not this time** and click **Next**.

In Windows Vista and Windows 7 systems, the Found New Hardware wizard pops up. Select **Locate and install driver software (recommended)**. Select **Continue** when asked for administrator permission.

Figure 2-11. New Hardware Found



3. In the next window, select **Install from a list or a specific location (Advanced)** and click **Next**. In Windows Vista and Windows 7, select **Browse my computer for driver software (Advanced)**.

Figure 2-12. Hardware Update Wizard



4. Select **Don't search. I will choose the driver to install** and click **Next**.

Figure 2-13. Choose Installation Options

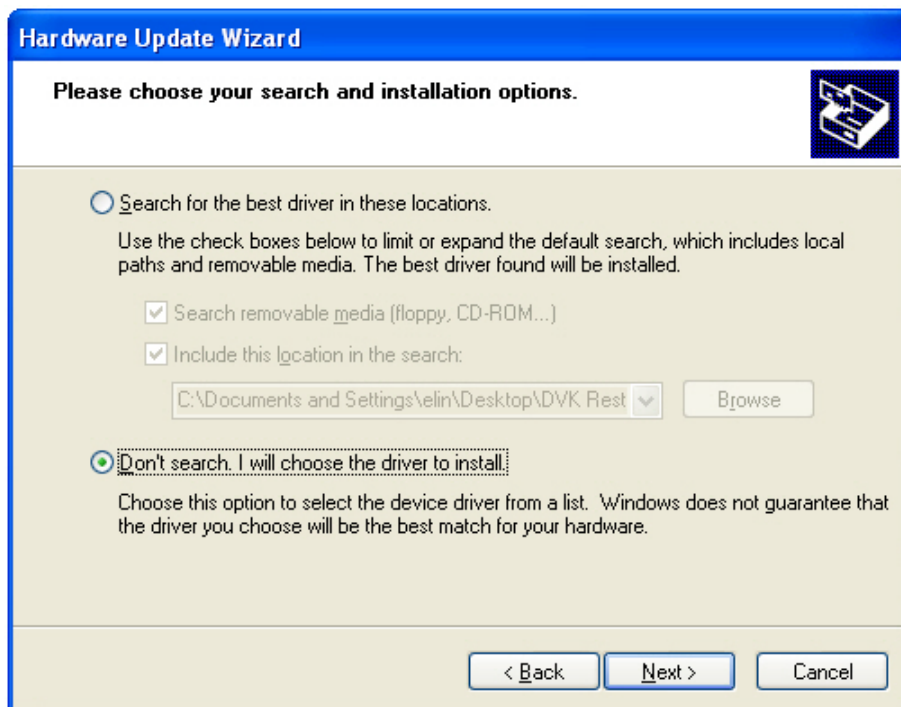

Note In Windows Vista and Windows 7, step 4 is not needed.

5. Select "Universal Serial Bus Controllers" from the list of devices and click on **Have Disk** in the next window. A new window appears on top of the existing window.
6. Click **Browse** and point to the driver path for each OS and select the driver information file (*cyusb3686dvc.inf*) as mentioned in the following paths. The USB driver path varies depending on the Windows OS to which the CY3686 DVC is connected. Following are relative paths with reference to the directory, <install directory>\CY3686 NX2LP-FLEX DVC\<ver>\Drivers
 - a. Windows XP 32-bit: wxp\x86
 - b. Windows XP 64-bit: wxp\x64
 - c. Windows Vista 32-bit: wlh-vista\x86
 - d. Windows Vista 64-bit: wlh-vista \x64
 - e. Windows 7 32-bit: wlh-win7\x86
 - f. Windows 7 64-bit: wlh-win7\x64

Note For configurations 1 to 4 use the *cyusb3686dvc.inf* file in the cyusb3686dvc folder. For configuration 5, use the *CyMonfx1_fx2lp.inf* file in the CyMonfx1_fx2lp directory.

Figure 2-14. Select the .inf file

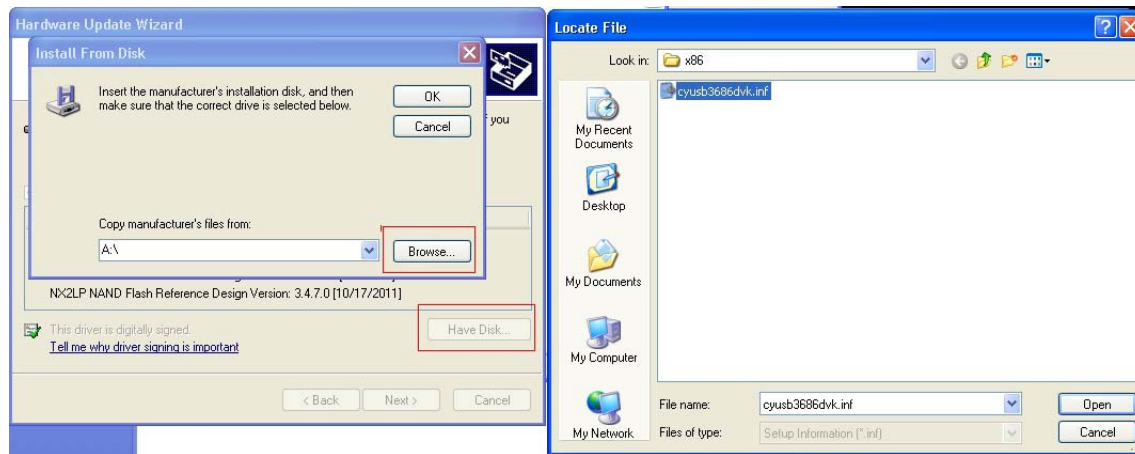

7. Click **Next** and then complete the installation.

Figure 2-15. Driver Installation Complete

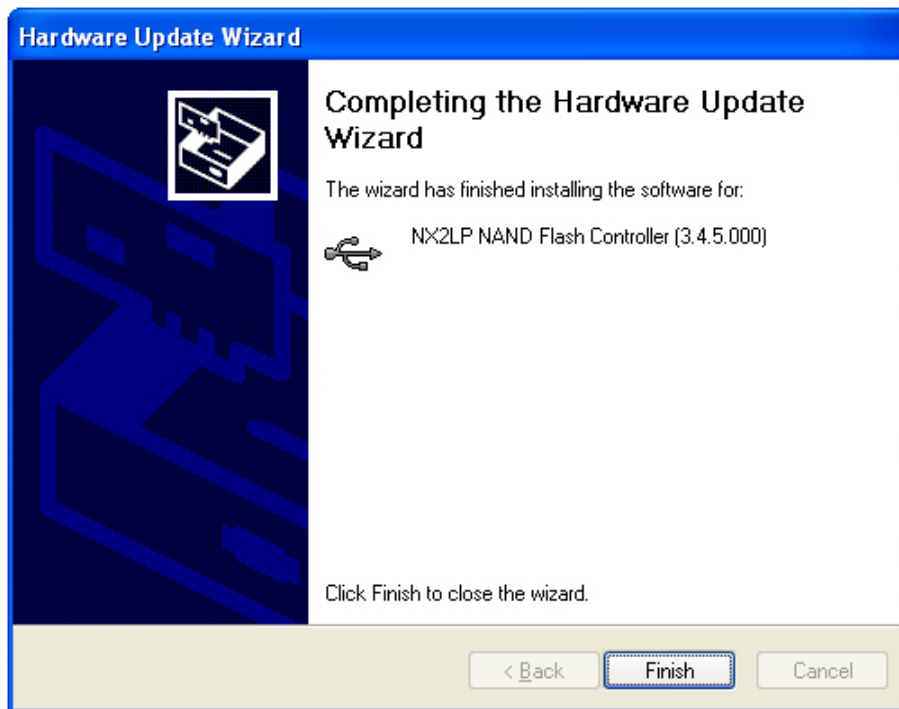

3. Kit Operation



This chapter explains the CY3686 NX2LP-Flex DVK operation.

3.1 Quick Start

The CY3686 EZ-USB NX2LP-Flex DVK default configuration is detected as a USB mass storage device when connected to the host PC for the first time. The NX2LP-Flex board comes with two programmed NAND flashes populated in the NAND slots. The FX2LP base board Large EEPROM is pre-loaded with *loader.iic*, which causes the FX2LP to emulate as an NX2LP-Flex.

1. Stack the FX2LP base board, FX2LP prototype board (optional), and the NX2LP-flex board
2. Verify if the settings on the FX2LP base board for switches SW1 and SW2 are identical to [Figure 4-2 on page 39](#).
3. For more information on the jumper settings, refer to [Table 4-1 on page 43](#).
4. Using the USB A-B cable provided, connect the FX2LP base board USB-B port to the Host PC.
5. The device now enumerates as a USB mass storage device and a removable disk appears on **My Computer**

3.2 Board Configuration

One of the following two combinations of board stackup is used:

1. FX2LP base board + FX2LP prototype board (Optional) + NX2LP-flex board

Figure 3-1. Board Stackup for NX2LP Emulation using FX2LP

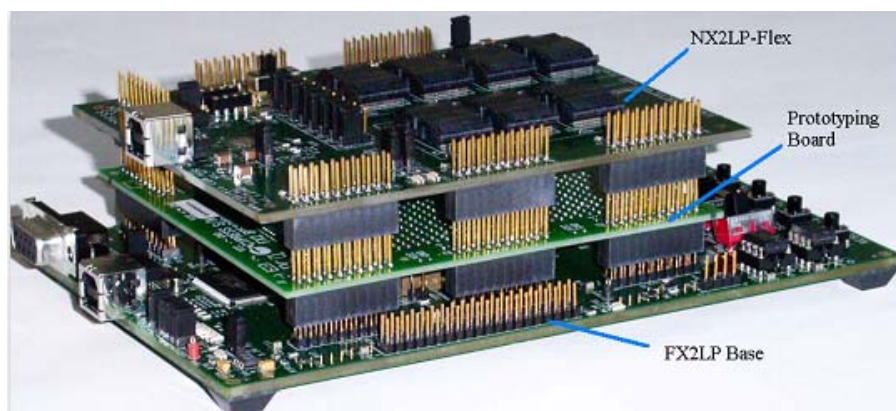

2. NX2LP-Flex board + FX2LP prototype board (optional)

Figure 3-2. NX2LP-Flex DVK Standalone Operation

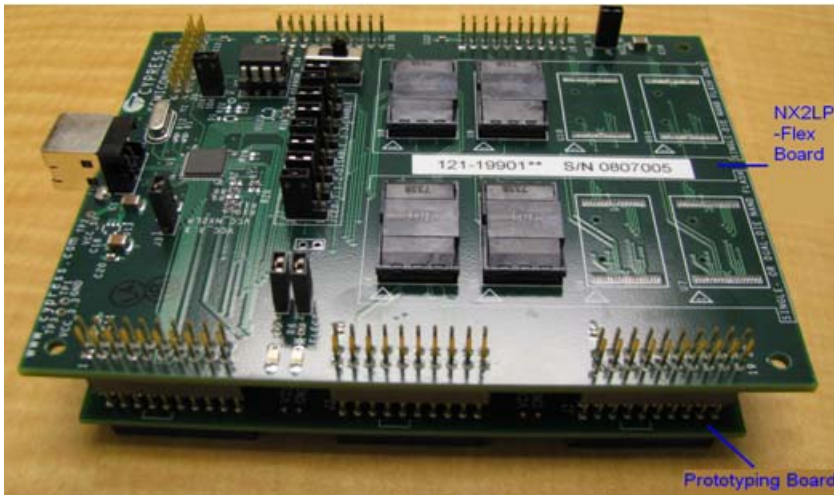

The following table lists useful configurations with CY3686 boards.

Table 3-1. Useful Board Configurations

Board Stackup	Board Settings*		Board Function		Tools and function
	FX2LP Base	NX2LP-Flex	FX2LP Base	NX2LP-Flex	
FX2LP Base Board+ Prototyping Board + NX2LP-Flex Board	SW1 : Small EEPROM SW2: EEPROM UART cable between PC and SIO-I USB A-B cable between host PC and connector on board	Pad U1: NC (unpopulated) Pad U2: NC Unprogrammed NAND flash device	FX2LP running NAND user firmware in debug mode	Housing for NAND flash device	Keil tool for compiling and debugging firmware EZUSB FX2LP DVK Keil monitor driver for handling USB communication.
FX2LP Base Board+ Prototyping Board + NX2LP- Flex Board	SW1 : Large EEPROM SW2: EEPROM USB A-B cable between host PC and connector on board	Pad U1: NC (unpopulated) Pad U2: NC Unprogrammed NAND flash device	FX2LP + "loader.iic" on large EEPROM emulating NX2LP programs flash with image LED's and push buttons for limited debug	Housing for NAND flash device. NAND flash device stores user firmware image	Keil tool for compiling firmware NAND firmware packager- packaging firmware to .Nx2 NAND programming utility to program firmware image into flash Nand controller Keil monitor driver for handling USB communication.
FX2LP Board+ Prototyping Board + NX2LP- Flex Board	SW1 : Large EEPROM SW2: EEPROM USB A-B cable between host PC and connector on board	Pad U1: NC Pad U2: NC Programmed NAND flash device	Power and housing for FX2LP part and the large EEPROM that emulate NX2LP USB-flash controller	Housing for NAND flash device. Firmware image is loaded from programmed NAND flash device	Mass Storage USB drivers to perform data transfers between host PC and NAND flash

Table 3-1. Useful Board Configurations

Board Stackup	Board Settings*		Board Function		Tools and function
	FX2LP Base	NX2LP-Flex	FX2LP Base	NX2LP-Flex	
NX2LP- Flex Board+ Prototyping Board	-	Pad U1: CY7C68013 (FX2LP) Pad U2: large EEPROM with "loader.iic" Unprogrammed NAND flash device	-	FX2LP + "loader.iic" on large EEPROM emulating NX2LP programs flash with image Housing for NAND flash device NAND flash device stores user firmware image	Keil tool for compiling firmware NAND firmware packager- packaging firmware to .Nx2 NAND programming utility to program firmware image into flash Nand controller device driver for handling USB communication
NX2LP- Flex Board+ Prototyping Board	-	Pad U1: CY7C68013 (FX2LP) Pad U2: large EEPROM with "loader.iic" Programmed NAND flash device	-	FX2LP + "loader.iic" on large EEPROM emulating NX2LP USB-flash controller Housing for NAND flash device Firmware image is loaded from programmed NAND flash device	Mass Storage USB drivers to perform data transfers between host PC and NAND flash
NX2LP- Flex Board+ Prototyping Board		Pad U1: CY7C68033/34 (NX2LP) Pad U2: NC Unprogrammed NAND flash device		NAND controller NX2LP programs the attached NAND flash device NAND flash device also stores user firmware image	Keil tool for compiling firmware NAND firmware packager- packaging firmware to .Nx2 NAND programming utility to program firmware image into flash Nand controller device driver for handling USB communication
NX2LP- Flex Board+ Prototyping Board		Pad U1: CY7C68033/34 (NX2LP) Pad U2: NC Programmed NAND flash device		NAND controller NX2LP provides USB-flash management Firmware image is loaded from programmed NAND flash	Mass Storage USB drivers to perform data transfers between host PC and NAND flash

***Note** The prototyping board is optional and is required only if the user wants to add hardware that draws input and feeds output to any of the signals on any of the six 20-pin headers.

3.3 NX2LP Utilities

This section describes the various DVK utilities.

3.3.1 CyConsole Utility

The Large EEPROM on the FX2LP base board comes pre-loaded with the *loader.iic*, which is available at <Installed_directory>\CY3686 NX2LP-FLEX DVK\<Ver>\Bootloader. If the EEPROM image is corrupted, you can reprogram the EEPROM using the CyConsole utility. Use the following procedure to program the EEPROM:

1. Connect the FX2LP base board and NX2LP-Flex board stackup to the host PC. Make sure the SW2 switch on the FX2LP base board is in the **No EEPROM** position.
2. Launch the utility from <install directory>\CY3686 NX2LP-FLEX DVK\<ver>\Bin\CyConsole.exe

Figure 3-3. CyConsole

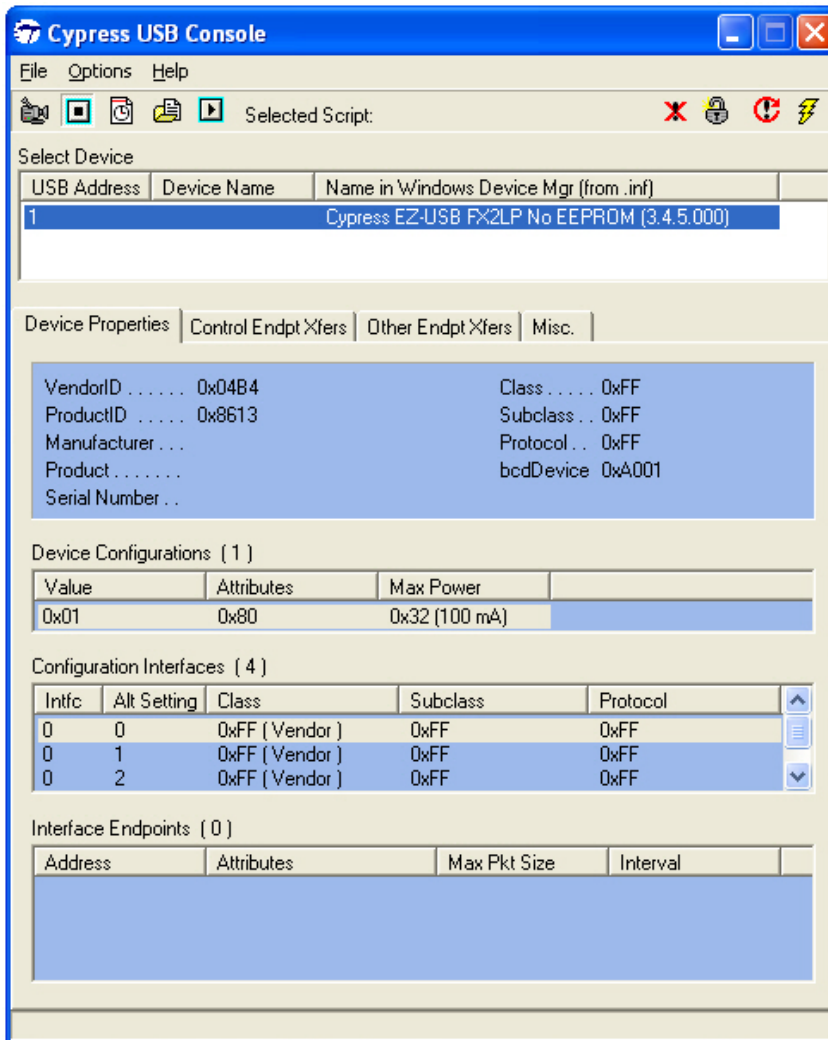

3. Go to **Options > EZ-USB Interface**

Figure 3-4. EZ-USB Interface

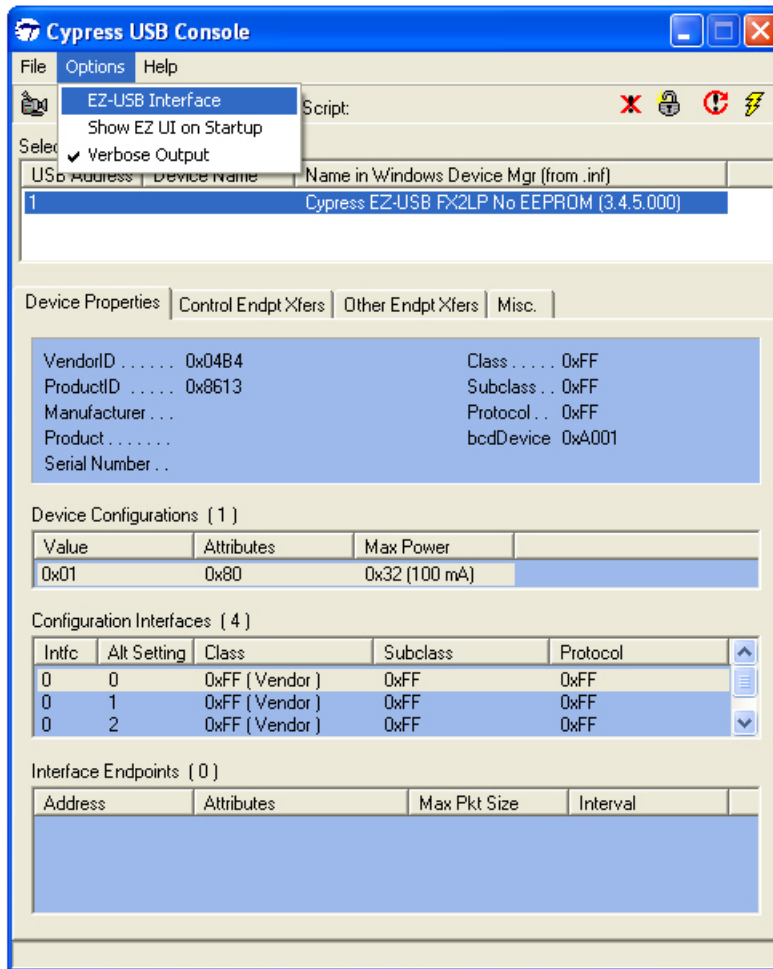

4. Click on **Lg EEPROM** and select the *loader.iic* file to be programmed from `<Installed_directory>\CY3686 NX2LP-FLEX DVK\<Ver>\Bootloader`. Make sure the SW2 switch on the FX2LP base board is in the 'EEPROM' position and SW1 to LARGE EEPROM position.

Figure 3-5. Select File

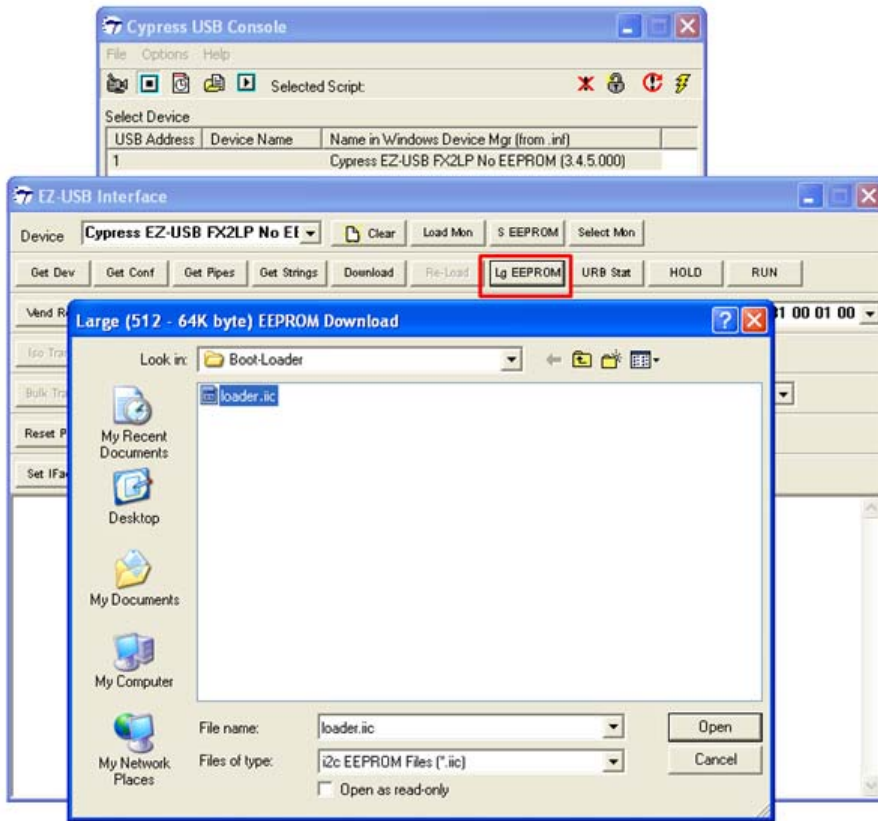

5. When programming is complete, the **Download Successful** message appears in the display area.

Figure 3-6. Programming Complete

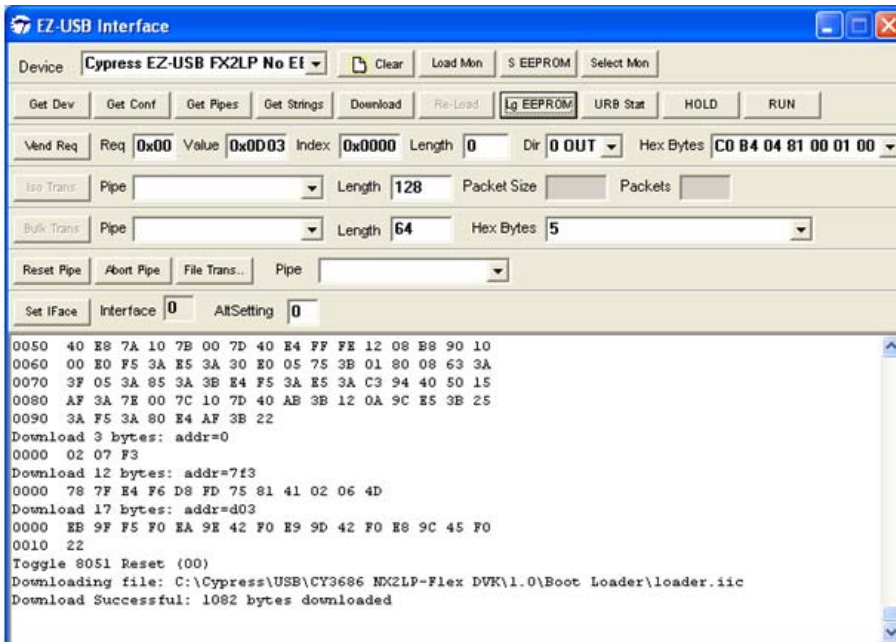

3.3.2 NAND FW Packaging Utility

When the firmware is stable, use the NX2LP firmware packaging utility to package it by selecting from `<install directory>\CY3686 NX2LP-FLEX DVK\<ver>\Bin\BldNx2.exe`. The following figure shows the NX2LP Firmware Packager (NX2LP configuration utility) window.

Figure 3-7. NAND FW Packaging Utility

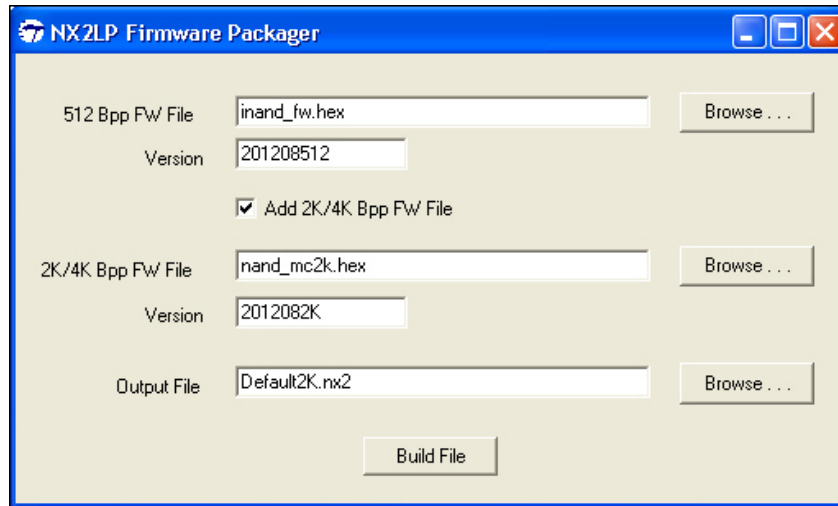

This utility is used to convert a `.hex` file to a `.nx2` file. Follow this procedure to package the firmware using the `BldNX2.exe` utility:

1. Click **Browse** and go to the *512 Bpp FW* file; select the following file:
`<install directory>\CY3686NX2LP-FLEX DVK\<ver>\CY3686FW\inand_fw.hex`
2. Provide a firmware version, such as "201001512", in the version box.
3. In the slot adjacent to the *2K Bpp FW* file, select the `nand_mc2k.hex` for a 2K-page NAND from the directory mentioned in step 1. Enter the output file name `Default2K.nx2`. Set the version (for example, 2010012K).
 Click **Build File** to generate the file. The output file contains NAND firmware in both the 512-byte and 2-K page sizes and the relevant firmware for a specific NAND is downloaded by the NAND-MFG tool.
4. For the 4-K page NAND device, select `nand_mc4k.hex` from the same folder. Also select `inand_fw.hex`. Enter the output file name, `Default4K.nx2`. Set the version (for example, 2010014K). Click **Build File** to generate the file. The output file contains NAND firmware in both 512-byte and 4-K page sizes and the relevant firmware for a specific NAND is downloaded by the NANDMFG tool.
5. Verify that the output file is created in the desired directory.

3.3.3 NAND Programming Utility

The NX2LP NAND Programming Utility is an application specifically designed to download vendor configuration parameters to an NX2LP NAND memory device and automatically initialize it with FAT32 formatting.

The utility can be used to program previously unprogrammed (that is, "raw") NAND devices or to reprogram preconfigured NAND devices and enumerate as Windows Mass Storage Class devices.

The NAND flash can be programmed using the `NANDMfg.exe` tool by following this procedure:

1. Launch the utility either from the shortcut on the desktop or from <install directory>\CY3686 NX2LP-FLEX DVK\<ver>\MfgTool\NandMfg.exe. Ensure that the tool is not locked. The **File > Lock** option must not be checked.

Figure 3-8. NAND Programming Utility

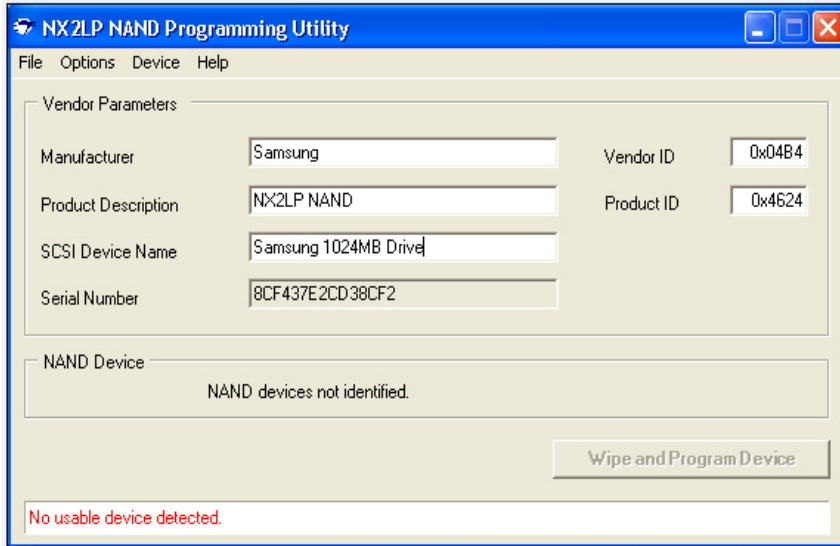

Note In Windows 7, the utility may not recognize the device and the status bar on the bottom of the utility remains blank. If this occurs, launch the utility from <install directory>\CY3686 NX2LP-FLEX DVK\<ver>\MfgTool\ only. Right click on the exe and select the '**Run as administrator**' option.

2. Connect the NX2LP-Flex DVK to the host PC. When an unprogrammed NAND device is detected by the Programming Utility, the message displayed on the status bar at the bottom of the utility changes as shown in the following screenshot. If **Add New Part** pops up, follow the instructions given in section 5.7.

Figure 3-9. Unprogrammed USB Device

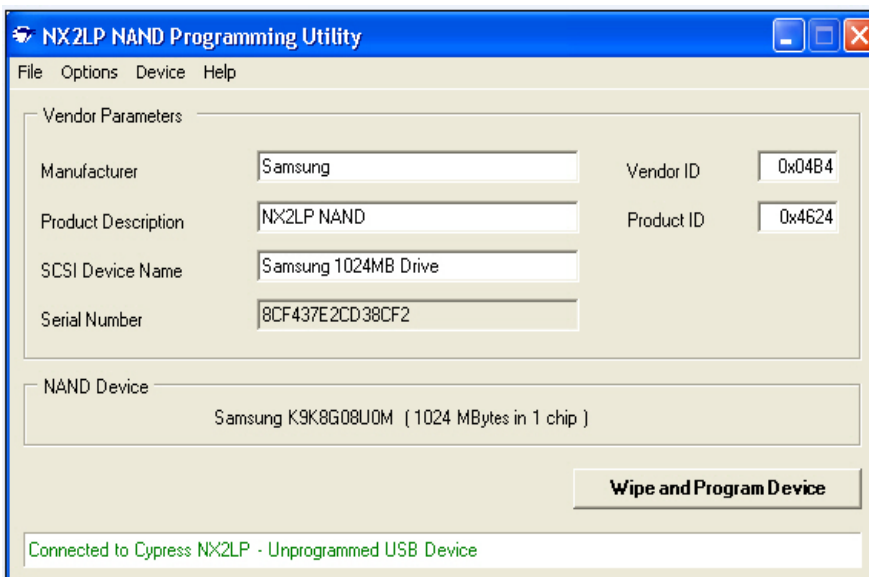

3. Select the configuration file from **File > Select Configuration**. The configuration files are in the folder, <install directory>\CY3686 NX2LP-FLEX DVK\<ver>\MfgTool\.

Figure 3-10. Select Configuration File

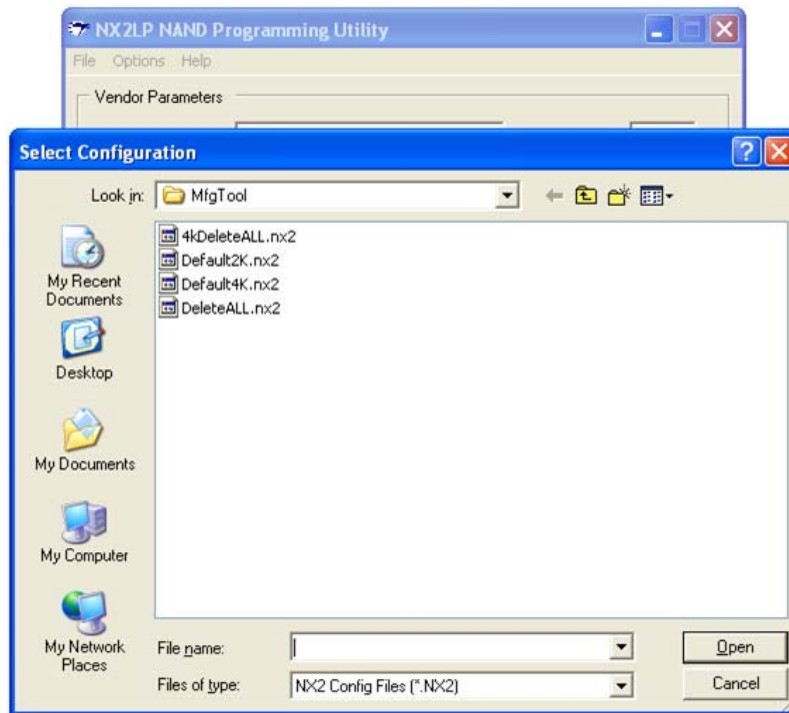

- Default4K.nx2 – Default firmware package for 4K-page NAND
- Default2K.nx2 – Default firmware package for 512 or 2K-page NAND
- DeleteAll.nx2 – The firmware package for 512/2k page flashes, which erase all of the blocks irrespective of the block status (that marks it good or bad). When the **CTL + W** command is issued using the NandMfg utility, with this firmware running, it erases all the blocks, including the ‘Bad’ blocks. Note that this also erases the Bad block information marked by the vendor.
- 4kDeleteALL.nx2 – The firmware package for 4k page flashes, which erase all the blocks irrespective of the block status (that marks it good or bad). When the **CTL + W** command is issued using the NandMfg utility, with this firmware running, it erases all the blocks, including the ‘Bad’ blocks. Note that this also erases the Bad block information marked by the vendor.

Note The default firmware packages (Default2k.nx2 and Default4k.nx2) erase only the good blocks on issuing the **CTL + W** command. The **DeleteAll** firmware packages command must be used only for debugging or recovery, if you corrupt the flash causing the blocks to be incorrectly marked as bad.

4. To program the vendor parameters and configuration settings to the device, click **Wipe and Program Device**. Clicking this button erases the NAND, programs the firmware to it, and formats it. Press RESET button S1 on the FX2LP board after this to observe the NAND flash device enumerate as a removable disk.
5. You can also perform the process mentioned in step 4 in different stages. Press CTRL + W for erase and then press the RESET button S1 on the board. Click **Device > Program** in the NAND-MFG tool to program and format the NAND device. Note that the NANDMFG tool does not activate the **Program** option unless you erase and RESET the board. This step is optional and the same can be achieved in a single step using the **Wipe and Program Device** button click (see

step 4). Do not program a formatted NAND unless it is erased earlier; not following this corrupts the device.

Note NandMfg supports formatting only for flashes with 2k-/512-byte page size. It relies on the host to format 4k page flashes.

Figure 3-11. Program Device

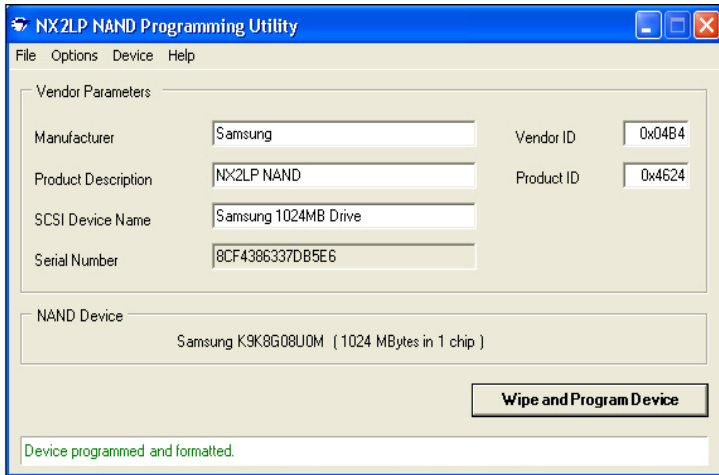

5. At this point, the device is configured as a fully-functional USB Mass Storage Class device. More details on the use of the manufacturing utility are given in Chapter 5.

Note While programming the NAND flash using the *NANDMfg.exe*, ensure that the PID displayed on the utility is not 0x4617/0x8613/0x6823/0x0082. If it displays any of the mentioned PIDs in the Product ID field, then manually change the value in the utility (see the following image) to any value of your choice other than the above mentioned PIDs. The PIDs mentioned in this section are signed by Microsoft for the cyusb.sys driver. When programmed with these PIDs, the programmed NAND flash does not enumerate as a USB Mass Storage Device.

Figure 3-12. Product ID (PID) Value

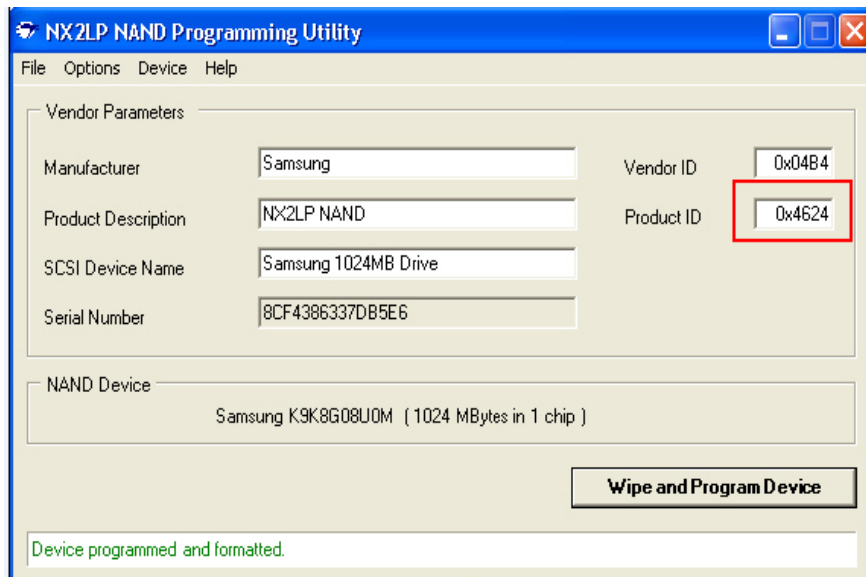

For more details on using the utility, refer to [NAND Manufacturing Utility](#) on page 47.

3.4 Debugging using Keil uVision

The CY3686 NX2LP-Flex DVK firmware is located at <install directory>\CY3686 NX2LP-FLEX DVK\<ver>\CY3686FW. The description of the firmware files is given in the following table.

Filename	Purpose
Dscr.a51	Descriptor table containing PID/VID, endpoint descriptions, and other information reported to the host on startup.
reset.a51	Assembly routine used to branch to 0 on USB reset.
Startup.a51	Modified Keil startup file that does not initialize any variables.
USBjmntbl.a51	USB interrupt vector table for FX2LP and NX2LP-Flex: When the NX2LP flag is defined, it selects the NX2LP interrupt vector
inand.c	NAND flash subroutines that handle SCSI reads and writes. The subroutines are: InitNand: NAND hardware/software initialization nGetFreeBlk: Search the gLog2Phy table to get free block nEraseBlock: Erase the used block memset16: Fill data nReadPages: CBW SCSI Read command ECCSetup: ECC setup to store to internal ram buffers CheckECC: Verify ECC Log2Phy: Get Physical block based on the LBA nCopyPages: Copy NAND data nSearchFreeBlock: Wear-leveling search for free block from gLog2Phy table nWritePages: CBW SCSI Write command CorrectData/CorrectDataX: ECC correction in the EP6 Buffer nNandMove: Internal move command for 2K NAND type
vend_cbw.c	Support for the NAND flash Manufacturing Utility command interface via the CBW. The subroutines are: Fifo6In: Setup EP6 for transfer data from NAND to FIFO6 Buffer NandSendCmd: General send a command to NAND NandRead: General read a page data from NAND GetNandType: Get 4-byte NAND ID and 2-byte of status NandSetAdd: General send address to the NAND nReadCfgPage: Reading NAND configuration pages nCopyBlock: Perform ECC correction while copying NAND data GetNandCfg: Get NAND configuration information CheckSignature: Check for special signature for the NAND configuration handleVendorCBW: <i>NandMfg.exe</i> commands interface loadEP2BC: Enpoint2 Control
fw.c	Frameworks based main routine: main: main program for this firmware SetupCommand: handle all chapter 9 commands via interrupt ISR_Sudav resume_isr: Resume ISR sendDescriptor: general sending descriptors
Globals.c	Global variable definitions.
ide.c	Handles SCSI commands. The subroutines are: IDECommand: Handles most of the UFI commands cMedia: Check Media waitForInBuffer: general polling endpoint 4 for IN buffer available loadEP4BC: endpoint 4 control

Filename	Purpose
periph.c	Hooks required to implement the USB peripheral functions TD_Init: Hardware/Software initialization TD_Poll: Task Dispatcher hook for USB Mass Storage Class ChkErr: ECC handler stallEP2OUT: force STALL on endpoint 2 sendUSBS: send SCSI CBS failedIn: force STALL on endpoint 4 mymemmovexx: general memory move subroutine
Globals.h	Global variable references
gpif.c and gpif.h	Header files containing hardware GPIF wave form.
scsi.h	SCSI command set
CY3686fw.Opt	Options for UV2 project
inand_fw.hex nand_fw512.hex nand_mc2k.hex nand_fw2k.hex nand_mc4k.hex nand_fw4k.hex	Output file from the linker inand_fw.hex: is the firmware file for NX2LP-Flex chip that support 512-NAND type nand_fw512.hex: is the firmware file for FX2LP chip that support for 512-NAND type nand_mc2k.hex: is the firmware file for NX2LP-Flex chip that support for 2K-NAND type nand_fw2k.hex: is the firmware file for FX2LP chip that support for 2K-NAND type nand_mc4k.hex: is the firmware file for NX2LP-Flex chip that support for 4K-NAND type nand_fw4k.hex: is the firmware file for FX2LP chip that support for 4K-NAND type
CY3686fw.Uv2	UV2 project file
ezusb.lib	FX2LP library file
fx2_intreg.inc	Include the definition for NX2LP-Flex interrupt vectors definitions and FX2LP interrupt vectors definitions

The following steps illustrate the CY3686 firmware debugging with the FX2LP Base board + NX2LP-Flex board stackup configuration using Keil uVision.

Note The CY3686 kit contains the Keil uVision2 evaluation version with a 4K code limit. To debug and compile the modified code, customers must purchase a full version from <http://www.keil.com/>

1. On the FX2LP base board, ensure the following:
 - a. SW1 is set to 'Small EEPROM' and SW2 is set to 'EEPROM'. If the Small EEPROM image is corrupted, program it using the CyConsole utility with *NX2LP-SmallEEPROM.iic* located at <install directory>\CY3686 NX2LP-FLEX DVK\<ver>\ Boot Loader\. Follow the programming steps given in [NAND FW Packaging Utility on page 27](#), but select the 'S EEPROM' button now.
 - b. The RS232 cable is connected from SIO-1 to the PC COM port
 - c. The USB cable is connected from J1 to the PC USB port
 - d. LED D7 is ON (green).
2. Uncheck the "Read Only" attribute in all the firmware files. The default location of the firmware directory is: <install directory>\CY3686 NX2LP-FLEX DVK\<ver>\CY3686FW
3. Browse and click the *CY3686fw.uv2* project file in the firmware directory to launch the uVision2 tool.

4. The CY3686 NX2LP-Flex is shipped with the 2K-NAND type; select the **NAND_FW2K** option.

Figure 3-13. Selecting NAND FW for 4K Page Device

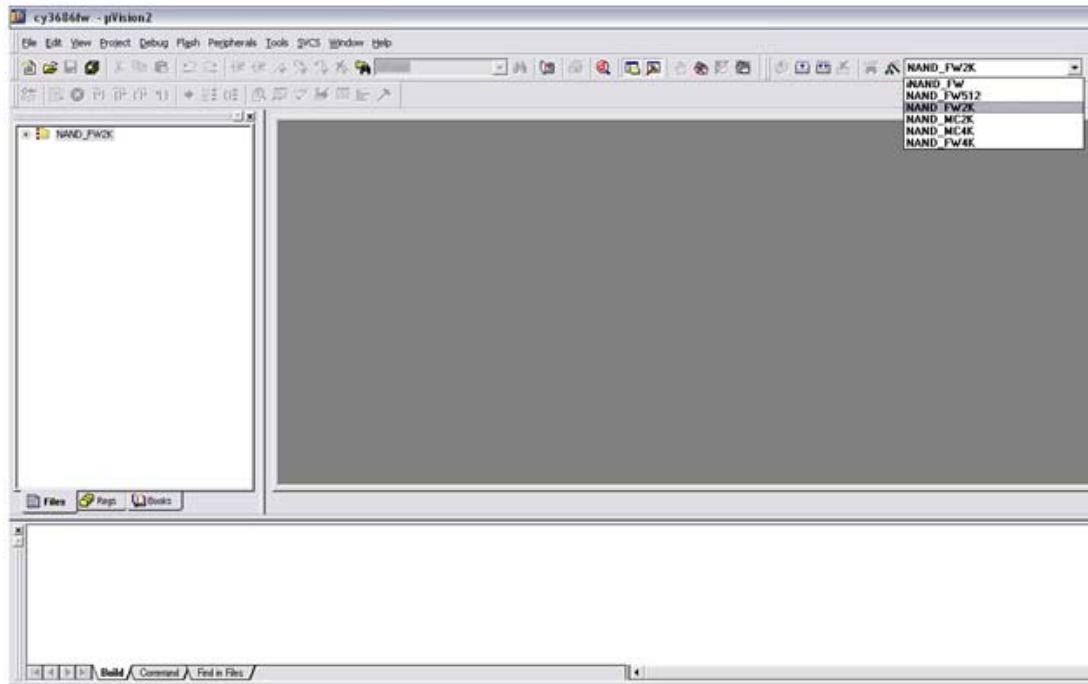

5. The "CY3686fw.uv2" setup assumes "COM1" is used; if the PC has an RS232 cable attached to a different COM port, perform these steps:
 - a. Right-click the NAND_FW4K project in the Files tab.
 - b. Select **Options** for Target 'NAND_FW4K'.
 - c. Click the **Debug** tab. Click the **Settings** button; the following window is displayed.
 - d. Using the drop-down menu, change the COM port and click **OK**.
 - e. Click **OK** until you exit all menus.

Figure 3-14. Setting up the COM Port for in Circuit Debugging

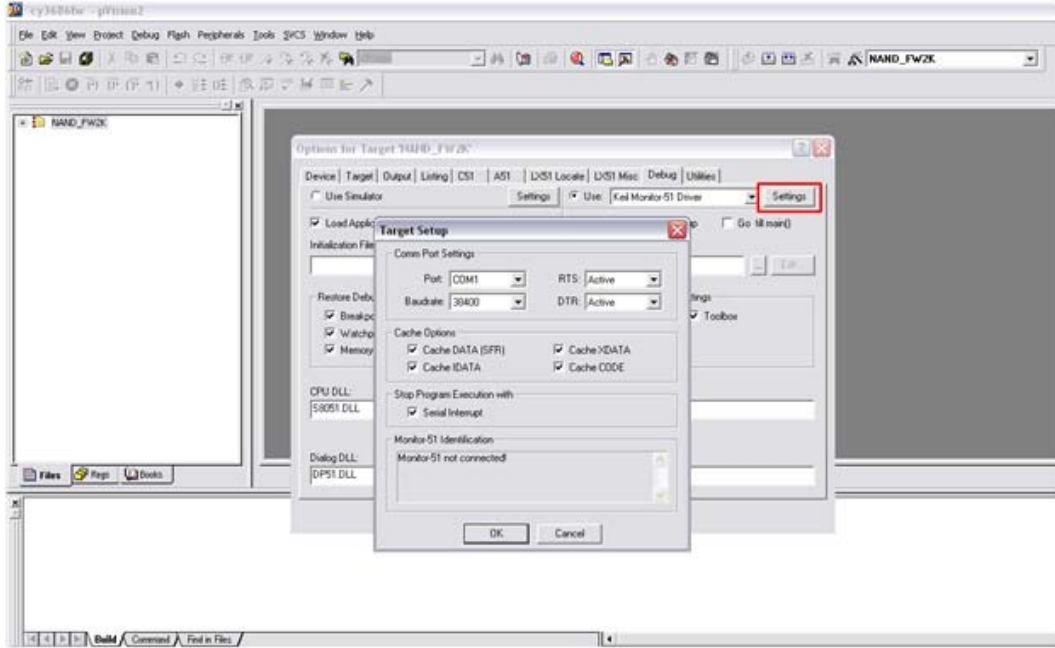

9. Press F7 to recompile the code. If successful, a window similar to the following is displayed.

Figure 3-15. Compiling NAND FW

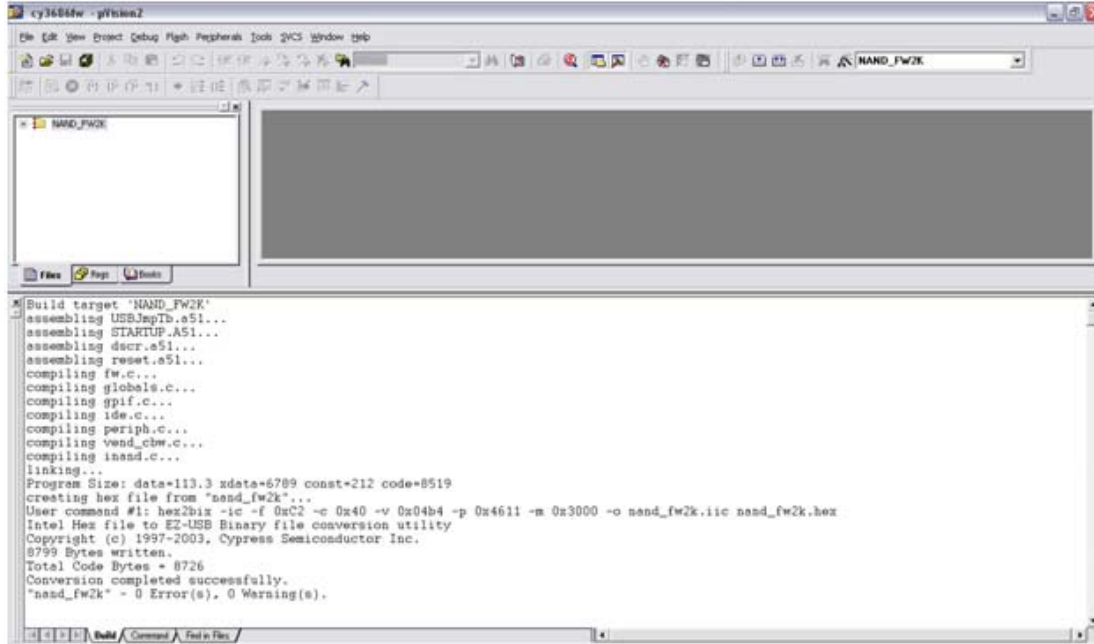

10. Download and run the firmware in debug mode.

11. Click **Download** to download the code; then click the **Reset** button . If successful, a window similar to the following is displayed.

Figure 3-16. Downloading and Debugging NAND FW

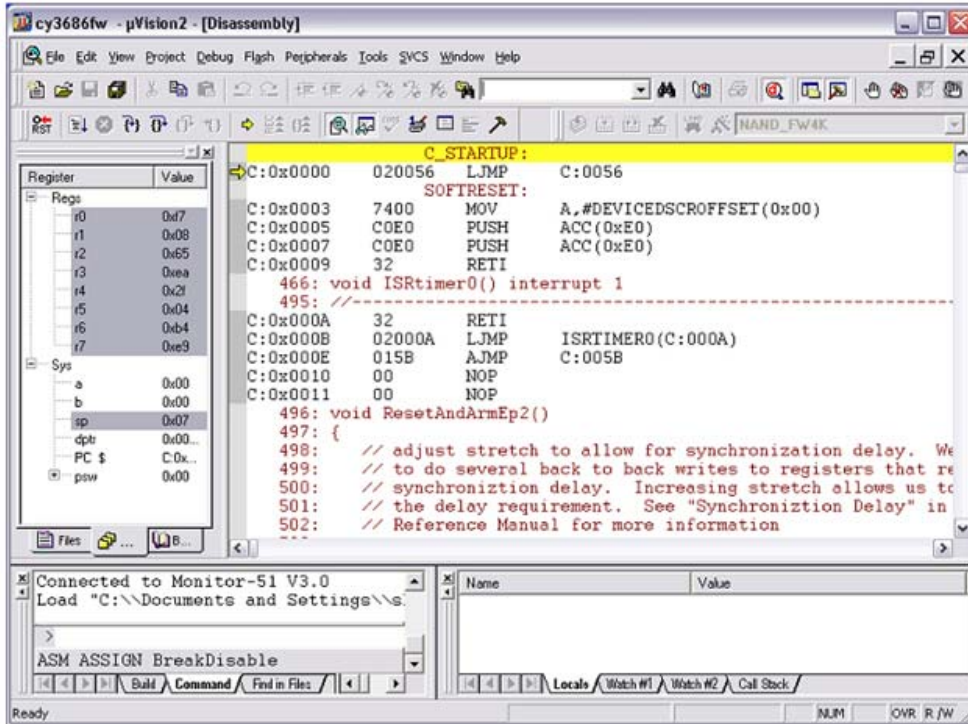

12. Press F5 to run the firmware; it enumerates as a USB Mass Storage device and the PC desktop mounts the "Drive" letter if there is a programmed NAND device on-board the NX2LP-Flex DVK. You can start transferring files between the local drive to this "Removable Disk".

4. Hardware



4.1 Overview

The CY3686 EZ-USB NX2LP-Flex DVK contains the following boards:

- The FX2LP base board
- The FX2 prototyping board
- The NX2LP Flex board

4.1.1 FX2LP Base Board

This is the same board that is shipped with the [CY3684 EZ-USB FX2LP DVK](#). This EZ-USB Advanced Development Board provides a compact evaluation and design vehicle for the EZ-USB FX2 family. The board provides expansion and interface signals on six 20-pin headers. Besides, the board provides a set of GPIO push button switches, GPIO LEDs, an I²C seven segment LED, and UART ports which enable users to quickly develop and test firmware for their applications.

NX2LP-Flex is derivative of FX2LP enabled by the latter's flexible GPIF interface and the highly configurable bootloader. Being the parent device, FX2LP can run the firmware targeted for a NX2LP device.

Using the standard RS-232 port available on FX2LP, the debugger interface of the Keil uvision tool can be used to connect, download, and debug your custom firmware image on the target hardware. This means the user can set break points and step through the code. LEDs and buttons on the FX2LP board provide additional debug functionality.

When booted from the attached I2C-EEPROM preloaded with a special NAND loader image (*loader.iic*), the FX2LP looks for the custom NX2LP NAND firmware from an attached NAND flash device just like any other NX2LP device.

[Figure 4-1](#) shows the FX2LP base board highlighting the key elements. The board is described in detail in the EZUSB FX2LP DVK (CY3684) and only the sections relevant to the NX2LP - Flex DVK are explained in this section.

Figure 4-1. FX2LP Base Board and Key Components

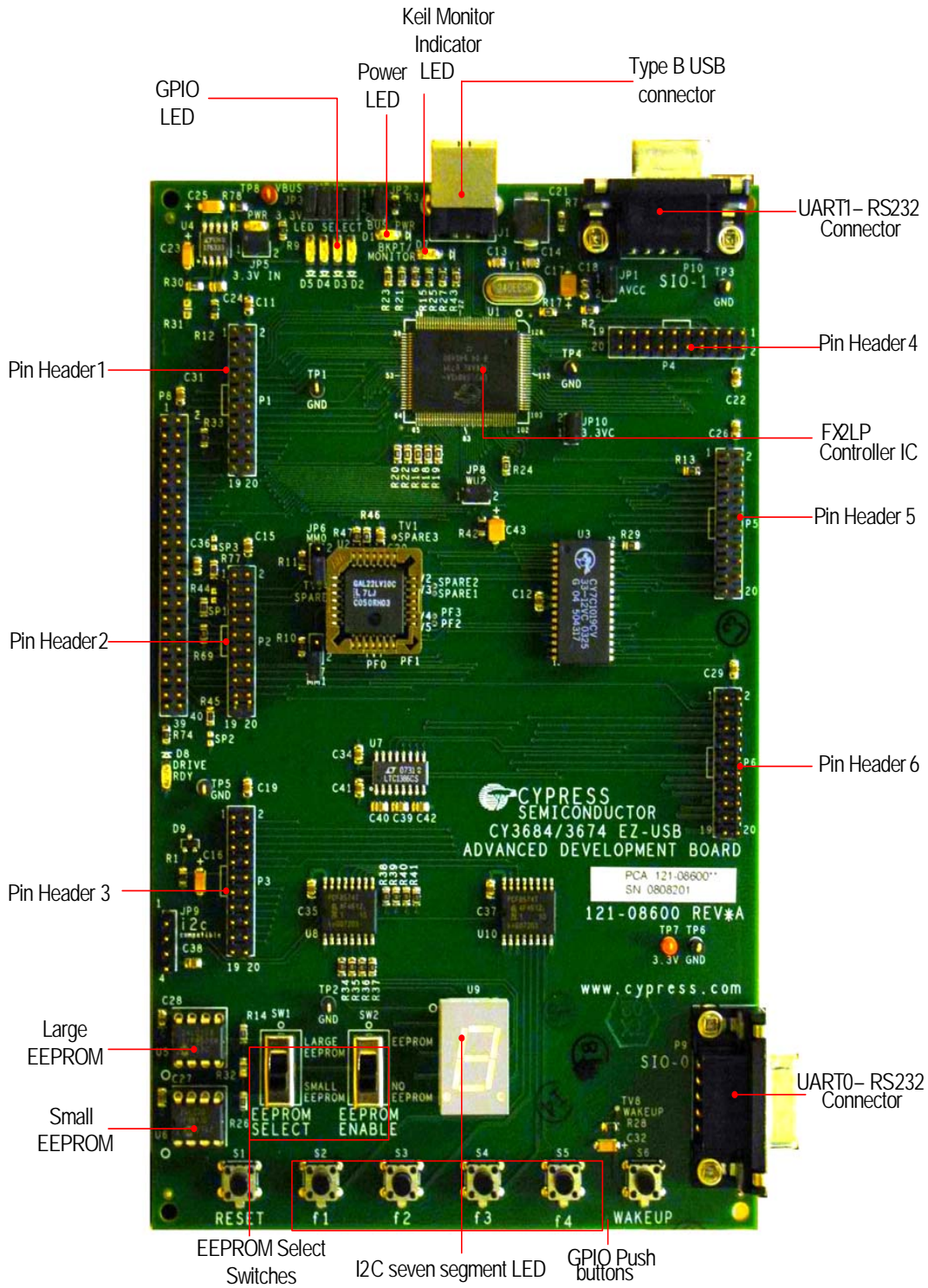

The default setting for the FX2LP Base board is shown in the following figure.

Figure 4-2. FX2LP Base Board Switch Settings

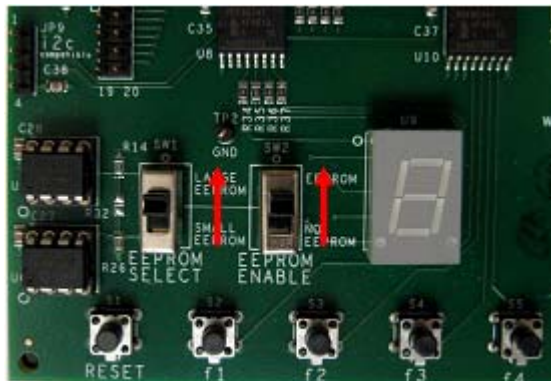

4.1.2 FX2LP Prototyping Board

The prototyping board, also known as the "FX2 breadboard", is provided to support additional hardware that the user may wish to add to the NX2LP flex DVK board and create prototypes for specific applications.

Figure 4-3. FX2LP Prototyping Board

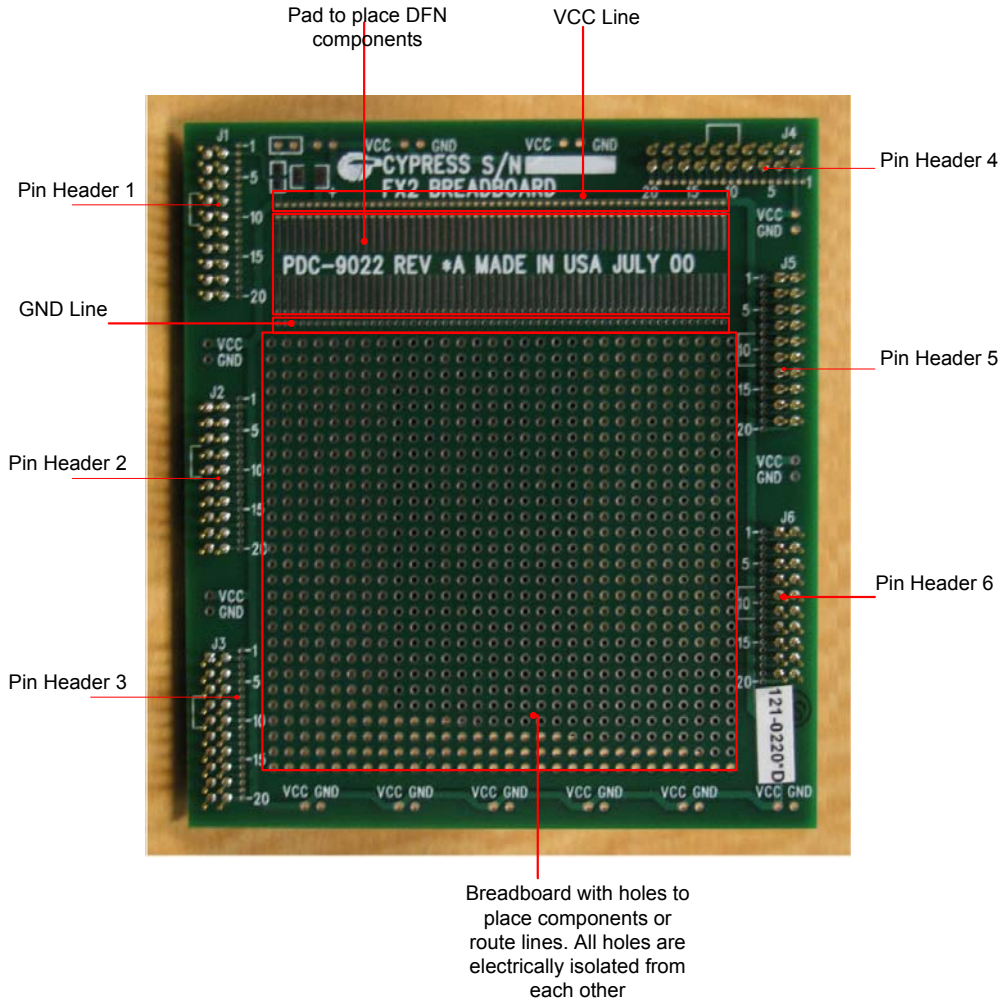

4.1.3 The NX2LP Flex Board

The NX2LP-Flex board is designed to support interfacing the CY7C68013, CY7C68033, and CY7C68034 with standard NAND flash devices. Pad U1 provides a mount for the FX2LP/NX2LP Flex controller chip while pad U2 enables loading an optional EEPROM. By default, these pads are not populated with the respective components in order to enable the user to explore the different options the NX2LP-Flex DVK provides to debug the NAND firmware. When U1 and U2 are populated, make sure that U12/D1 and U13 are populated. Refer to the schematics in [DVK Board Schematics chapter on page 59](#) for further details.

Figure 4-4. NX2LP Flex Board and Key Components

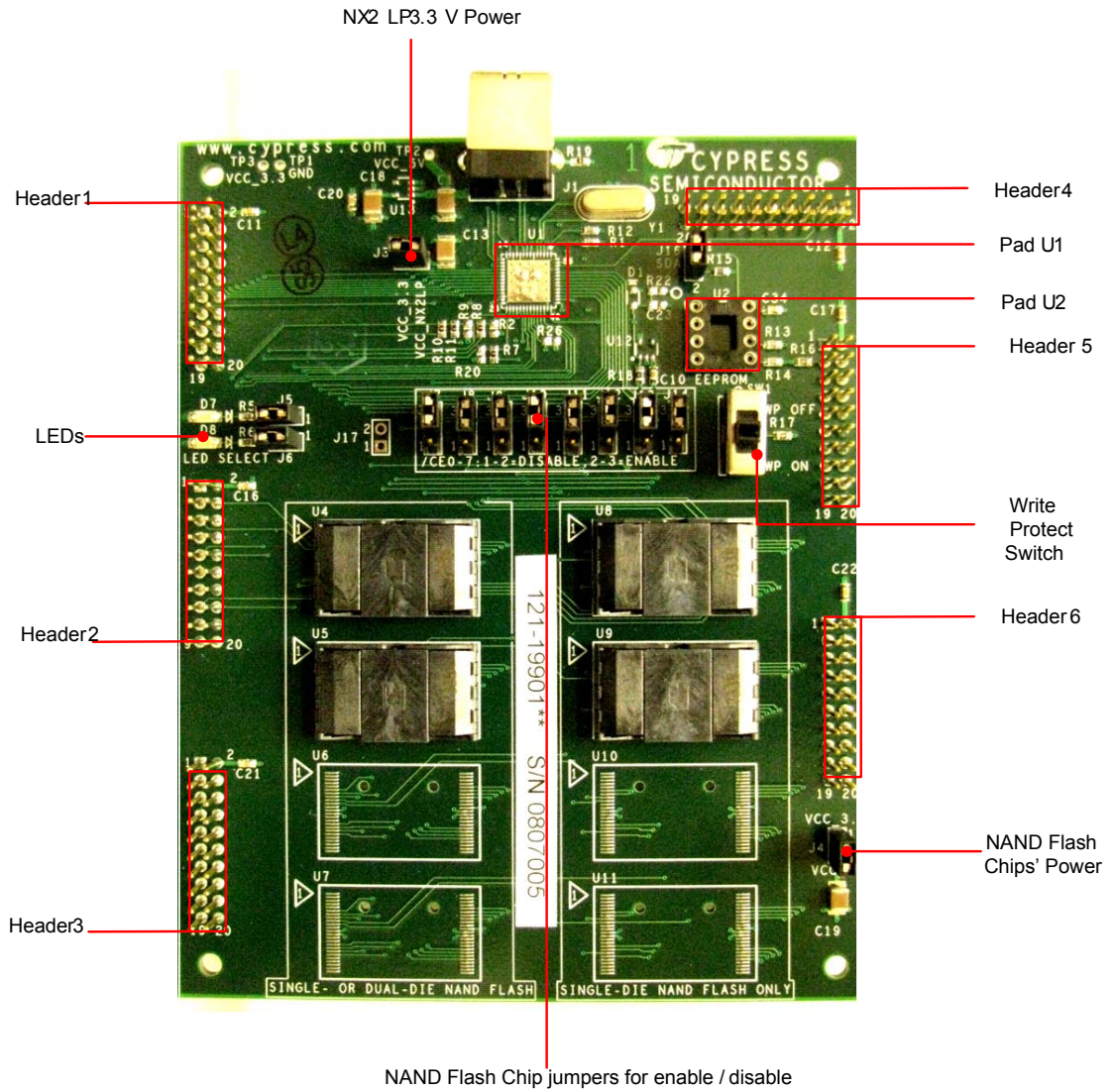

Note U4-U11 are NAND sockets.

The NX2LP-Flex board supports the following NAND flash features:

- 1-8 single-device or 1-4 dual-device NAND flash chips with ×8 organization
- 512-byte for each page (BPP), 2048 (2K) BPP, and 4096 (4K) BPP NAND flash devices
 - 512 BPP supports 512 MB to 1 GB NAND flash devices
 - 2 K BPP supports 1 GB to 8 GB NAND flash devices
- 4K BPP supports up to 32 GB NAND flash devices
- Jumper options for flexible testing and configuration
- Pin headers for easy debugging and signal analysis
- 48-pin TSOP NAND flash package support
- Write-protect switch
- Dual-LED operation and power control features
- Download-over-USB for device programming

4.2 NX2LP Flex Board Details

4.2.1 Jumper Settings and Switch Configurations

The NX2LP-Flex comes with the following jumper and switch settings.

Figure 4-5. NX2LP Flex Board-Default Switch Settings

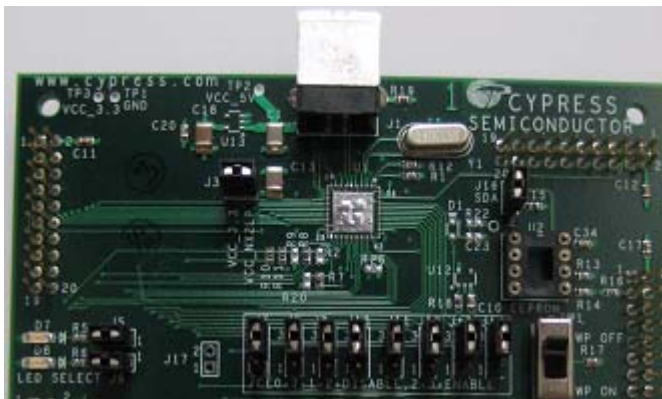

4.2.1.1 NX2LP-Flex Board Jumper and Switch Configurations

Table 4-1. NX2LP-Flex Board Jumper and Switch Configurations

Jumper/Switch Location	Jumper/Switch Descriptions	Default Jumper Install	Connection
J3	Power on/off to EZ-USB NX2LP	On	1-2
J4	Power on/off for all NAND flash devices	On	1-2
J5	LED D7 enable/disable. NAND flash activity indicator.	On	1-2
J6	LED D8 enable/disable (Spare)	On	1-2
J7	U4 enable/disable control	On	2-3
J8	U8 enable/disable control	On	2-3
J9	U5 enable/disable control	On	2-3
J10	U9 enable/disable control	On	2-3
J11	U6 enable/disable control	On	2-3
J12	U10 enable/disable control	On	2-3
J13	U7 enable/disable control	On	2-3
J14	U11 enable/disable control	On	2-3
J16	I2C enable/disable control	On	1-2
SW1	Write-protect Switch ON Write-protect Switch OFF	Switch OFF	

The default configuration and functionality of the jumpers is discussed in [NX2LP-Flex Board Hardware Configuration on page 45](#).

4.2.2 NX2LP-Flex Board Header Configurations

This design contains six logic analyzer headers. The functionality of these headers is described here. Refer to the NX2LP-Flex board [datasheet](#) for specific chip pin descriptions and functionality.

Table 4-2. NX2LP-Flex Board Header Configurations

Header Label	Header Pin	Pin Name	NX2LP-Flexboard signals
P1	1	NC	No connect
	2	VCC_3.3	3.3V Power
	3	NC	No connect
	4	nXCE7	Chip enable #7
	5	nXCE6	Chip enable #6
	6	nXCE5	Chip enable #5
	7	nXCE4	Chip enable #4
	8	nXCE3	Chip enable #3
	9	nXCE2	Chip enable #2
	10	nXCE1	Chip enable #1
	11	nXCE0	Chip enable #0
	12	D7	Data 7
	13	D6	Data 6
	14	D5	Data 5
	15	D4	Data 4
	16	D3	Data 3
	17	D2	Data 2
	18	D1	Data 1
	19	D0	Data 0
	20	GND	Ground
P2	1	NC	No connect
	2	VCC_3.3	3.3V Power
	3	NC	No connect
	4	R_nB2	Ready/Busy 2
	5	R_nB1	Ready/Busy 1
	6	NC	No connect
	7	NC	No connect
	8	NC	No connect
	9	nXRE1	Read enable 1
	10	nXRE0	Read enable 0
	11	nXWE	Write enable
	12	NC3	Unused GPIO pins for NX2LP-Flex
	13	NC2	Unused GPIO pins for NX2LP-Flex
	14	nWP_SW	Write-protect switch input
	15	nWP_NF	Write-protect NAND flash
	16	nLED2	Chip active LED sink
	17	nLED1	Data activity LED sink
	18	ALE	Address latch enable
	19	CLE	Command latch enable
	20	GND	Ground
P3		Unused header	
P4	3	NC1	Unused GPIO pins for NX2LP-Flex
P4	Other pins	Unused	
P5	3	NC1	Unused GPIO pins for NX2LP-Flex
P5	Other pins	Unused	
P6	10	SDA	I2C data
P6	11	SCL	I2C clock
P6	Other pins	Unused	

4.2.3 NX2LP-Flex Board Hardware Configuration

This section describes how to configure the NX2LP-Flex board. Sockets are provided on the NX2LP-Flex board for development convenience in testing a variety of NAND flash parts. Because of the many different NAND types available on the market, it is important to configure the NX2LP-Flex board properly to ensure correct operation. The following table provides four simple questions that assist in understanding how to configure your board.

Note All NAND configuration changes must be performed after disconnecting from the USB bus.

Table 4-3. NAND Flash Parameters

Questions
Q1: NAND flash vendor?
Q2: NAND flash part number?
Q3: Single- or dual-device part? (Note Single-device parts have one CE pin, dual-device parts have two CE pins.)
Q4: Total NAND flash devices (1-8 for single-device or 1-4 for dual-device)?

1. Insert NAND devices into sockets (U4-U11)

The NX2LP-Flex board supports up to eight single-device or four dual-device NAND flash chips. The same part type (vendor, part number) must be loaded in the NX2LP-Flex board for it to function correctly. Do not mismatch NAND flash devices as it can corrupt data.

Warning: The NAND flash sockets are rated by their manufacturer for 50 insertions and can be damaged by careless handling. However, with care, more insertions are possible. Use caution when inserting or removing NAND flash devices from the sockets. Be certain to install the parts so pin 1 is in the upper left corner. Pin 1 is clearly marked on the NX2LP-Flex board with a triangle at each socket.

Depending on the response to Question #3, follow these directions:

- Single-Device Parts - one CE pin
 - Install the NAND flash devices in the following order until you reach the total listed in response to Q4: U4, U8, U5, U9, U6, U10, U7, U11
- Dual-Device Parts - two CE pins
 - Install the NAND flash devices in the following order until you reach the total listed in response to Q4: U4, U5, U6, U7

2. Configure NAND flash jumpers J7-J14

It is possible to enable or disable individual NAND flash chips using jumpers J7-J14. The NX2LP-Flex device detects NAND flash in the following order:

- For single-device parts: U4, U8, U5, U9, U6, U10, U7, U11
- For dual-device parts: U4, U5, U6, U7

For example, for single-device parts, if U5 is disabled by shunting pins 1-2 of jumper J9 (see [Table 4-4](#). U5 and the parts after it (U9, U6, U10, U7, and U11) are not detected by the NX2LP-Flex at power on).

By default J7-J14 should be shunted across pins 2-3. The following tables show how to enable or disable NAND flash devices by configuring J7-J14. This is preferable to removing NAND flash devices and extends socket life.

4.2.3.1 Single-Device Parts

Individual NAND flash devices can be enabled and disabled as shown in the following table.

Table 4-4. Single-Device Parts Configuration of J7-J14

Jumpers	Jumper Settings	
	Shunt 1-2	Shunt 2-3
J7	Disable U4	Enable U4
J8	Disable U8	Enable U8
J9	Disable U5	Enable U5
J10	Disable U9	Enable U9
J11	Disable U6	Enable U6
J12	Disable U10	Enable U10
J13	Disable U7	Enable U7
J14	Disable U11	Enable U11

4.2.3.2 Dual-Device Parts

For dual-die NAND flash devices, the jumpers must be enabled or disabled in pairs as shown in the following table.

Table 4-5. Dual-Device Parts Configuration of J7-J14

Jumpers	Jumper Settings	
	Shunt 1-2	Shunt 2-3
J7 and J8	Disable U4	Enable U4
J9 and J10	Disable U5	Enable U5
J11 and J12	Disable U6	Enable U6
J13 and J14	Disable U7	Enable U7

5. NAND Manufacturing Utility



5.1 Operation Overview

The NX2LP NAND Programming Utility is an application designed to download vendor configuration parameters to an NX2LP NAND memory device and automatically initialize it with FAT32 formatting.

The utility can be used to program previously un-programmed (that is, "raw") NAND flash or to reprogram preconfigured NAND flash devices and enumerate as Windows Mass Storage Class devices.

The application automatically detects the presence of a usable NX2LP device on the USB. Connect the NX2LP device to the PC's USB and run the NX2LP NAND Programming Utility. The status bar at the bottom of the application window displays the identified device.

The current selections for all parameter fields are stored each time the program closes. These are then restored each time the program runs. The parameters presented by the application can be locked such that the operator only has the ability to view the parameters and to click the **Wipe and Program Device** button. This facilitates the configuration of the software parameters by one "administrator" while restricting the functionality to a one-button "program" operation for a manufacturing operator.

When the program is launched, the status bar indicates "No usable device detected" if no NX2LP-Flex devices are attached to the USB.

Figure 5-1. NX2LP NAND Programming Utility

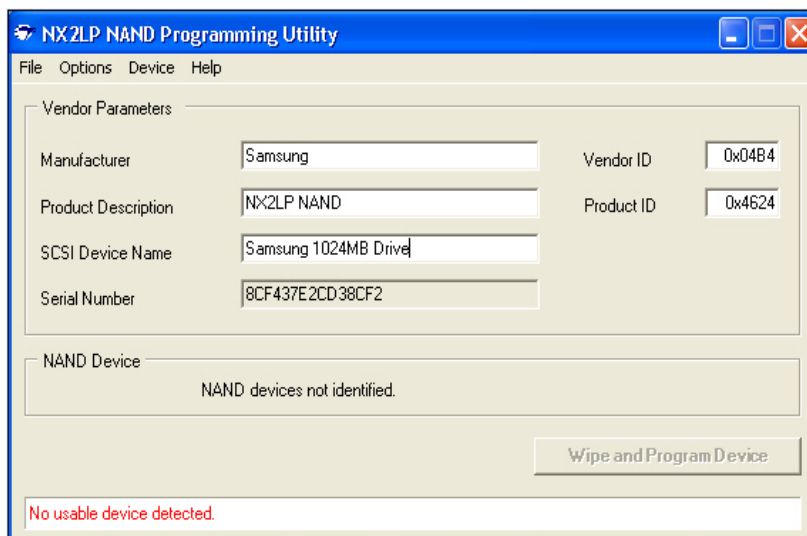

When you attach a NX2LP device with unprogrammed Nand flash to the USB the first time, Windows asks for a device driver. Refer to the section [Installing the CY3686 DVK Device Drivers on page 14](#) for further details.

After Windows finds the driver for the NX2LP device, NandMfg identifies the flash parts which populate the device and displays information about them in the NAND Device box. However, if “Add New Part” pops up, follow the instructions given in section 5.7.

Figure 5-2. Unprogrammed USB Device

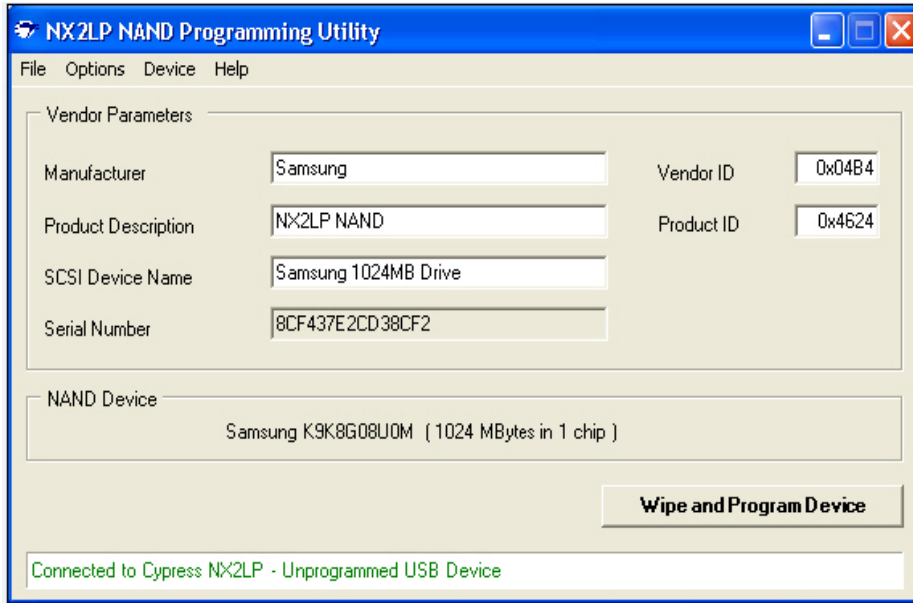

At this point, the NAND flash device is ready to be programmed with the parameters displayed. Select the appropriate config file and then click **Wipe and Program Device** to program the parameters into the device and format the media to FAT32.

5.2 Vendor Parameters

The Vendor Parameters are USB and SCSI parameters that are reported by the device to the operating system when the device is attached to the PC.

- Manufacturer

The manufacturer string can contain up to 23 characters. The entry field limits the length of the string for you.

- Product Descr

The product description string can contain up to 23 characters. The entry field limits the length of the string for you.

- SCSI Device Name

The SCSI device name string can contain up to 24 characters. The entry field limits the length of the string for you.

- Serial Number

All USB devices should report a unique serial number. This allows the operating system to track separate devices of the same type that are connected to the computer.

The NX2LP programmer programs each device with a serial number composed of 15 hexadecimal characters.

■ Vendor ID

The vendor ID is a two-byte value assigned to each USB device vendor by the USB Implementors' Forum (USBIF). The value should be entered as a hexadecimal value with a prefix of "0x". For example, the Cypress vendor ID is 0x04B4.

■ Product ID

The product ID is a two-byte hexadecimal value that the vendor assigns to a product. The value should be entered as a hexadecimal value with a prefix of "0x". While programming the NAND flash, using the *NANDMfg.exe*, ensure that the PID displayed on the utility is not 0x4617, 0x8613, 0x6823, or 0x0082. If it displays any of these PIDs in the PID field, then manually change the value in the utility to any value of your choice other than the PIDs mentioned here. These PIDs are signed by Microsoft for the cyusb.sys driver. When programmed with these PIDs, the programmed NAND flash does not enumerate as a USB Mass Storage Device.

Figure 5-3. Vendor Parameters

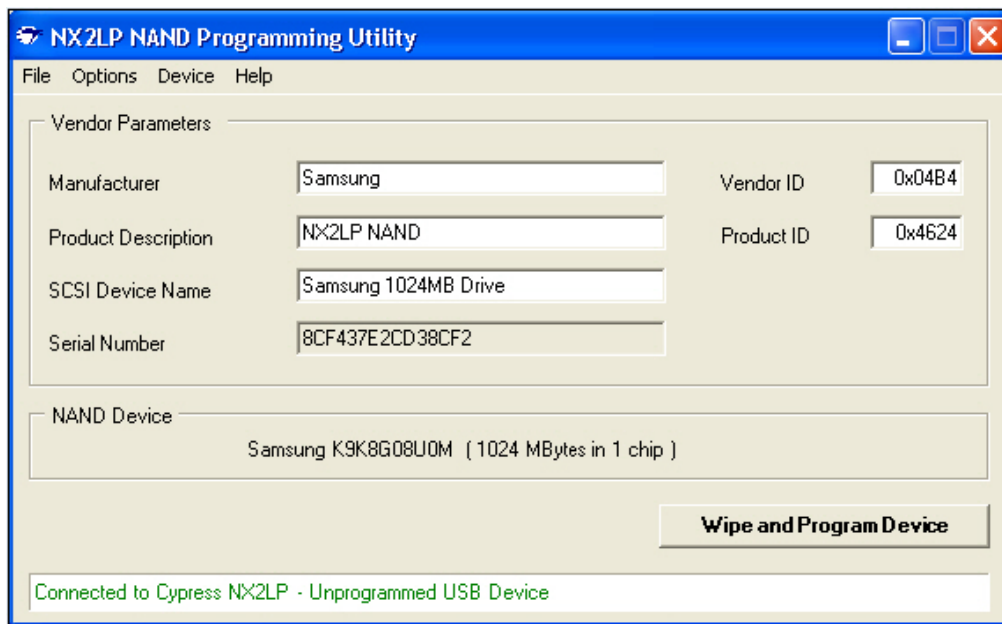

5.3 Options Menu

The Options menu has four settings, which should be configured before connecting any NX2LP device. Click on any of the items in the drop-down menu to check or uncheck it.

■ Auto Program on Device Connect

If this item is checked, the programming utility automatically begins programming the device when it is connected. The operator does not need to click the **Wipe and Program Device** button. Erase the NAND device using the short key, CTL + W, and then press the RESET button S1 on FX2LP. Then, the NANDMFG tool automatically downloads firmware and formats the NAND device. Press RESET again to observe a removable disk.

Note The utility does not automatically re-program a pre-configured device.

■ Enable Write Protect

If you check this item, your device implements a write-protect switch. If this item is checked, the utility does not attempt to format the media. If you enable the write protect bit from the tool, the device always enumerates as a removable disk. If you disable the write protect bit from the tool, the device

always enumerates as a hard disk. This feature is used in applications where you do not want to enumerate any removable device. If the device enumerates as a hard drive the first time, you must first initialize it and then format it for use.

Figure 5-4. Options Menu

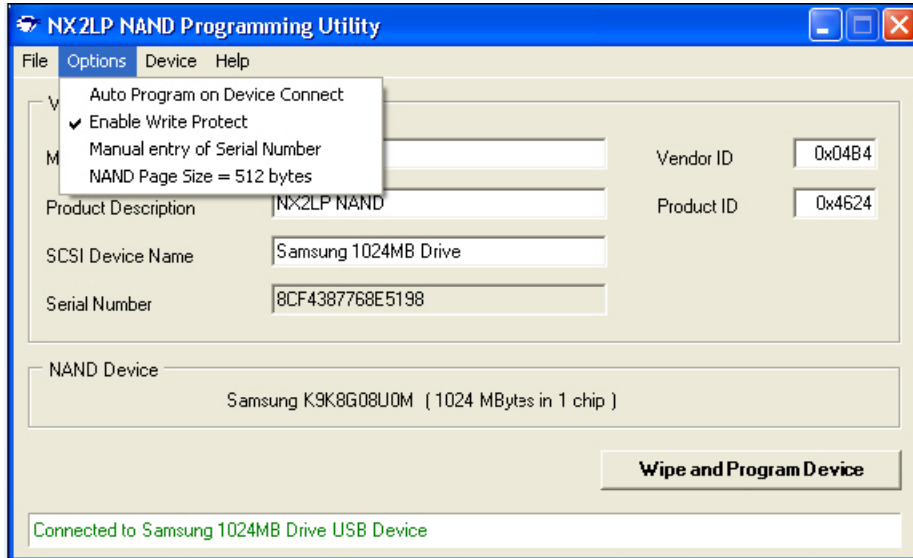

- Manual entry of Serial Number

By default, the NX2LP Programmer automatically generates a new 15-digit serial number after each successful programming of the device. The operator can enter the serial number manually by checking **Manual entry of Serial Number**.

Note Valid serial numbers are at least 12 characters in length and contain only hexadecimal digits. If the **Manual entry of Serial Number** item is not checked when the "Program Device" button is clicked, the displayed serial number is programmed to the device. Then, a new serial number is generated and displayed. Therefore, the displayed serial number is always the one that is about to be programmed and not the one that has already been used.

- NAND Page Size = 512 bytes

It is crucial that this item accurately reflects the type of NAND flash part that is being programmed. Check this item if the NAND flash parts in the device have a page size of 512 bytes. If the parts have a larger page size (typically 2048/4096 bytes), make sure this item is not checked.

5.4 Device Menu

This utility provides four functions that are invoked by clicking on them. Alternately, you can press down the CTRL key while pressing another key as a shortcut.

Figure 5-5. Device Menu Options

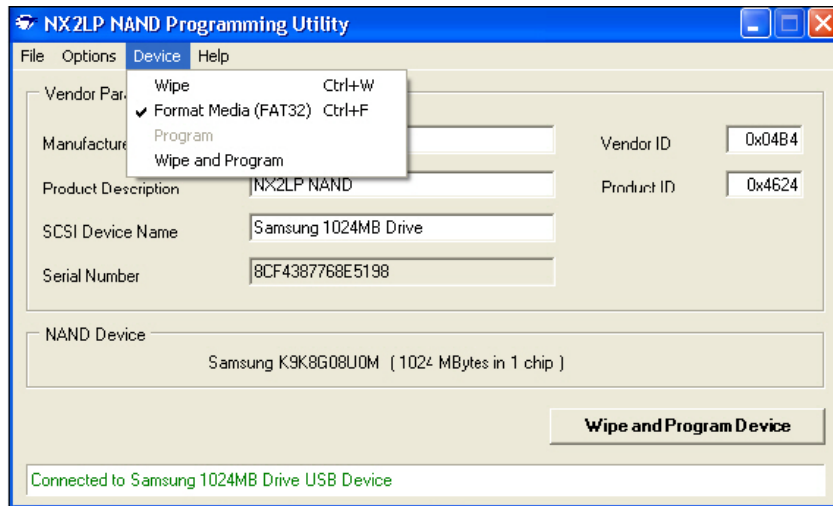

- Wipe (Ctrl + W)

This command completely erases the contents of all the NAND chips in the attached device.

- Format Media(FAT32) (Ctrl + F)

This command toggles formatting of the media ON and OFF. By default, the utility imposes a FAT32 format on the media at the conclusion of the programming process. If you do not want FAT32 formatting, this step can be disabled by pressing CTRL-F. The FAT32 format can be externally done from Windows PC by right-clicking the removable disk and selecting the **Format** option in the menu. After Format completion the removable disk can be accessed.

- Program

After erasing the NAND device press RESET button S1 on the EZ-USB FX2LP board. The NAND-MFG tool enables this button only after a proper Erase cycle, enabling you to program the NAND flash. Re-programming an already programmed NAND corrupts the NAND memory device.

- Wipe and Program

This option is provided to avoid NAND device corruption by re-programming an already programmed NAND device. The button "Wipe and Program Device" also serves the same purpose. You can either choose to erase and then program separately using the above options, or perform the entire operation in a single step using this feature.

5.5 CTRL Key Commands

This utility provides three functions that are invoked by holding down the Ctrl key while pressing another key. These functions are used occasionally and, therefore, not shown in the user interface of the utility.

- Lock: CTRL-I (L)

This command locks and unlocks the user interface. To prevent accidental changes to vendor parameters or options, access to these fields can be disabled by pressing Ctrl-I to lock the user interface.

- Wipe: CTRL-w

This command, CTRL-w, completely erases the contents of all the NAND chips in the attached device.

WARNING: This command results in permanent loss of all data and formatting in the device. It restores the device to the raw, pre-configured state.

- Formatting On/Off: CTRL-f

This command toggles formatting of the media ON and OFF. By default, the utility imposes a FAT32 format on the media at the conclusion of the programming process. If you do not want FAT32 formatting, this step can be disabled by pressing CTRL-f.

5.6 Programming Devices

The NX2LP NAND Programming Utility is used to configure a connected NAND flash device. Programming comprises downloading the displayed parameters along with a set of other configuration settings, and then formatting the drive media in the FAT32 format. The configuration in use can be displayed by clicking on **Help > About**.

The following figure shows that the default configuration is used. Other configurations, if provided, can be selected using **File > Select Configuration**.

Figure 5-6. Default Configuration in Use



When an un-configured NAND flash device is detected by the Programming Utility, the status bar at the bottom of the window displays "Connected to Cypress NX2LP - Unprogrammed USB Device".

Figure 5-7. Unprogrammed USB Device

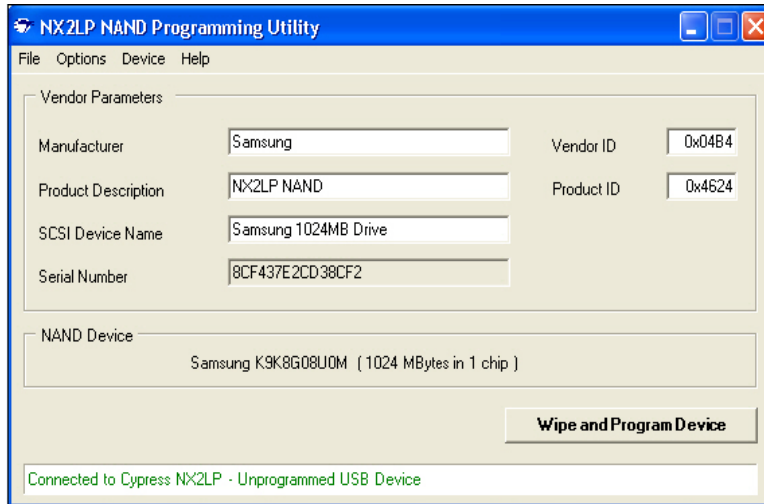

To program the Vendor Parameters and the Configuration Settings to the flash device, click **Program Device**. After successful programming and formatting, the status bar displays "Device programmed and formatted". NandMfg supports formatting only for flashes with 2k or 512-byte page sizes. It relies on the host to format 4-k page flashes.

Figure 5-8. Device Programmed and Formatted

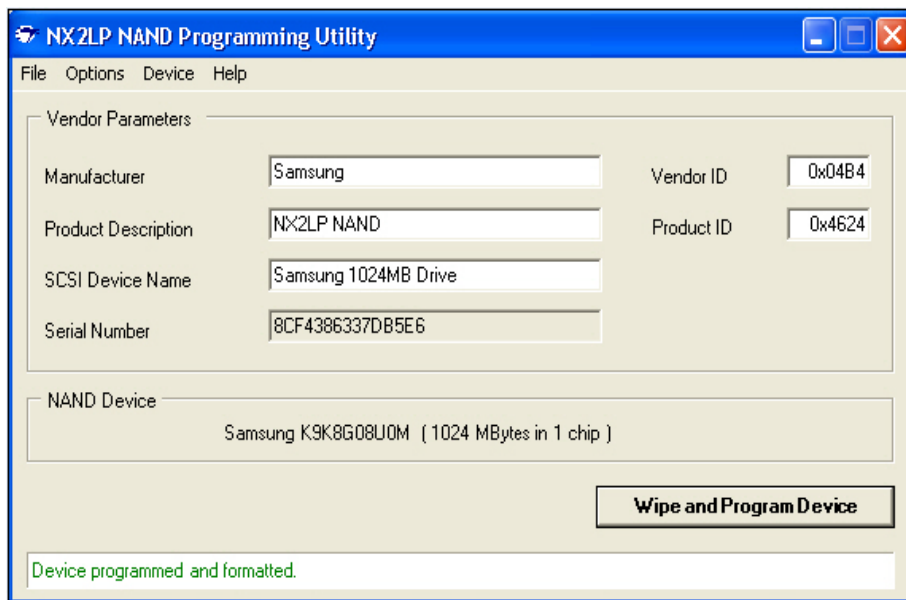

At this point, the device is configured as a fully functional USB Mass Storage Class device.

Figure 5-9. Programmed Device

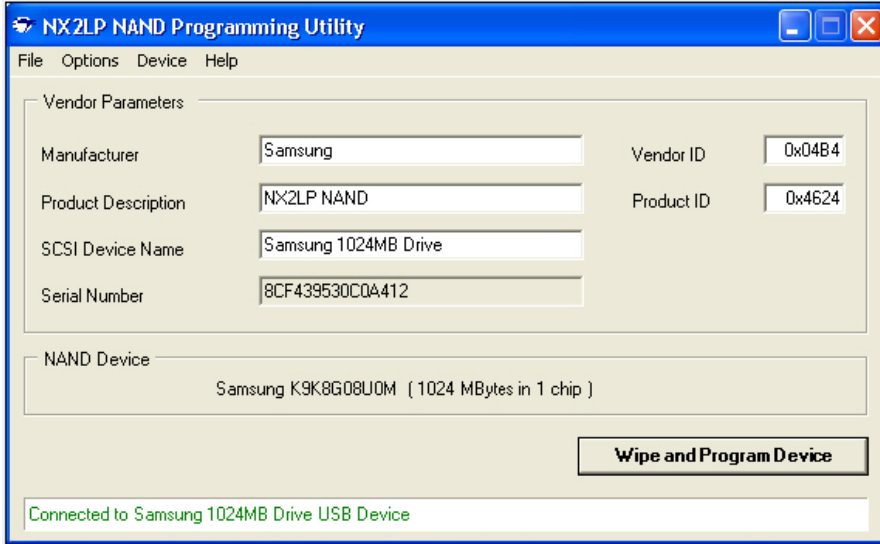

5.7 Reprogramming Devices

The NX2LP NAND Programming Utility can be used to update (that is, reprogram) an NAND flash device. When an NX2LP device is already programmed, Windows sees it as a USB Mass Storage Device. Because the NX2LP NAND Programming Utility can only program NAND flashes mounted on Cypress NX2LP devices, it needs a method to discern NX2LP storage devices from other (non-NX2LP) devices. This distinction is made based on the device's VID/PID.

Figure 5-10. Device Reprogramming

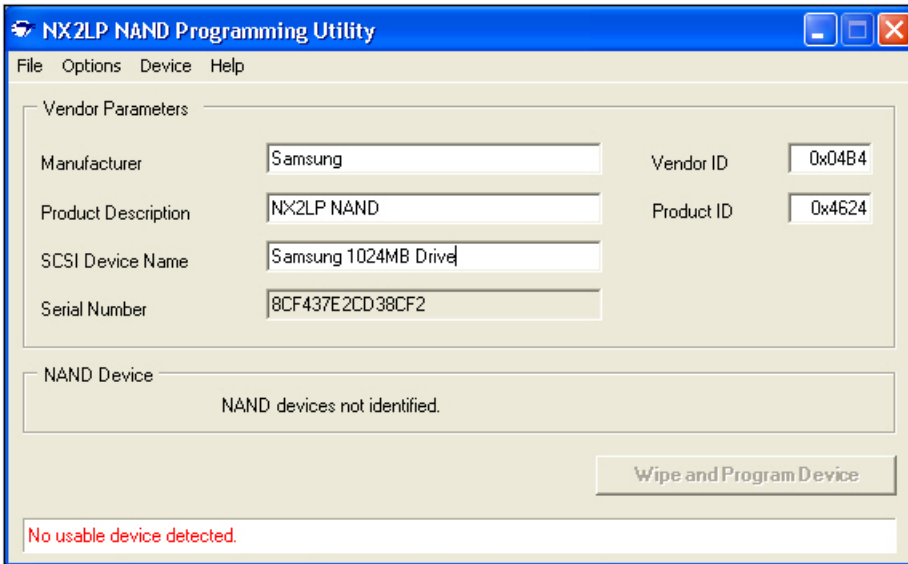

If you connect a programmed, functional, NX2LP-based storage device and the NX2LP NAND Programming Utility displays "No usable device detected" in the status bar, you must enter the VID/ PID of the connected device into the corresponding fields of the utility. When the cursor moves away from the PID field, the utility checks to see if the attached device matches the new VID/PID.

Figure 5-11. Device Detected after VID Change

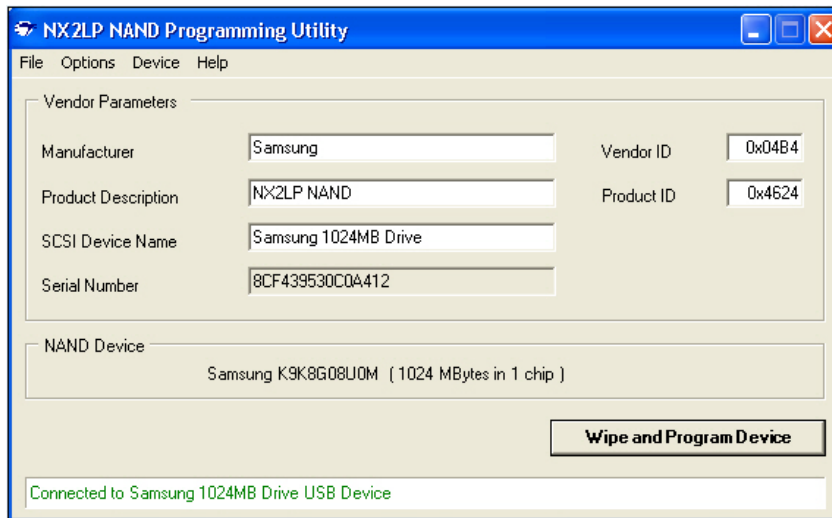

Note that you can reprogram a NAND device only after erasing the existing contents. Until the NAND device is erased and RESET (disconnected and reconnected), the **Device > Program** option is disabled. Cypress recommends using the **Wipe and program Device** button, which takes care of the entire process. If the NandMfg tool is stuck on reconnect with the status '**Identifying Device..**', then make sure that the Configuration file selected is correct before reconnecting.

5.8 Support for NAND Parts

The NX2LP Programming Utility needs to know several parameters about the actual NAND chips used in the NX2LP memory device. Rather than require user entry of these parameters, the utility searches for these parameters in the *NandParts.xml* file located at <install directory>\CY3686 NX2LP-FLEX DVK\<ver>\MfgTool.

If a part cannot be found in the lookup table is detected, the following dialog box pops up. For the NAND parts to function properly with the NX2LP, it is crucial that the parameters in the dialog are set accurately.

The Manufacturer ID and the PID are values that the NX2LP retrieved from the NAND parts themselves. The user cannot change these fields. They serve as the index into the lookup table. The other parameters should be obtained from the NAND device's datasheet, provided by the NAND device manufacturer.

Figure 5-12. New NAND Part

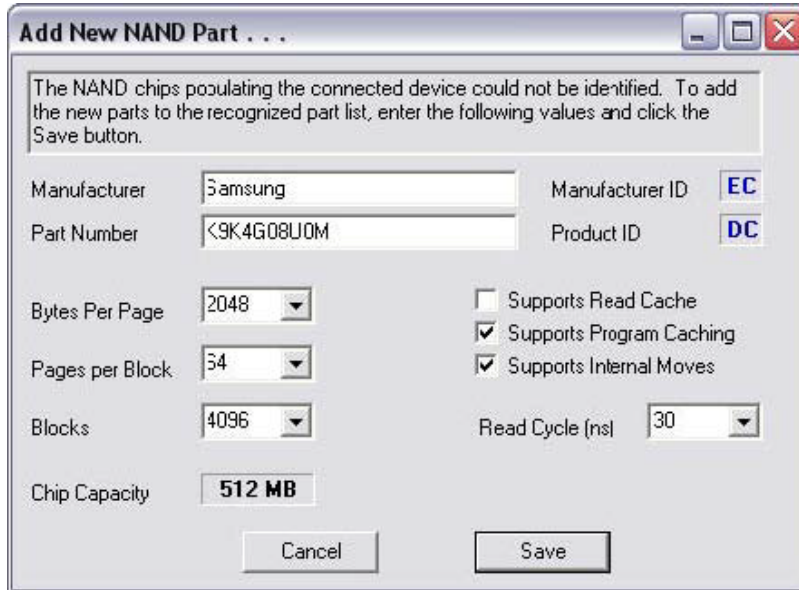

The NAND chips populating the connected device could not be identified. To add the new parts to the recognized part list, enter the following values and click the Save button.

Manufacturer	Samsung	Manufacturer ID	EC
Part Number	<9K4G08U0M	Product ID	DC
Bytes Per Page	2048	<input type="checkbox"/> Supports Read Cache	
Pages per Block	34	<input checked="" type="checkbox"/> Supports Program Caching	
Blocks	4096	<input checked="" type="checkbox"/> Supports Internal Moves	
Chip Capacity	512 MB	Read Cycle (ns)	30

Buttons: Cancel, Save

When you click **Save**, the parameters are saved in a second lookup table called *OtherParts.xml*, located at <install directory>\CY3686 NX2LP-FLEX DVK\<ver>\MfgTool. This table is always searched before *NandParts.xml* when the utility tries to identify a part.

OtherParts.xml is not distributed with the NX2LP Programming Utility because it does not yet exist and is created by the utility when a new part's parameters need to be saved. This means that, if wrong values are mistakenly saved using the dialog shown in the previous screenshot, the *OtherParts.xml* table can be manually deleted without breaking the tool.

(CAUTION: Deleting *OtherParts.xml* removes all parts whose parameters are manually entered through this dialog. If you added several new parts and decide to delete the file, you must make a backup copy first).

Finally, as indicated by the *.xml* file extension, *OtherParts.xml* is an XML file. It can be easily modified with a simple text editor. The structure of the XML elements that comprise the file is quite simple. With a little XML knowledge and a limited amount of pattern matching skill, the file can be manually modified to remove bad entries or add additional ones. *OtherParts.xml* and *NandParts.xml* use identical XML element structures).

A. Appendix



A.1 Firmware Design Notes

The CY3686 EZ-USB NX2LP-Flex DVK is a flexible NAND flash solution that provides additional features that can be added to a USB thumb drive solution. The Cypress EZ-USB NX2LP-Flex Mass Storage reference design connects the EZ-USB NX2LP-Flex to the following device types:

- 512 byte page, 2 KB page, and 4 KB page flash chips
- 25 ns - 90 ns access time chips
- Flash chips with single and multiple chip selects (maximum eight)

Refer to the document, "NX2LP-Flex™ USB to NAND flash Firmware Design Notes - AN61347", on <http://www.cypress.com/?rID=43431> for more information. It is also located in the installed directory at <install directory>\CY3686 NX2LP-FLEX DVK\<ver>\Documentation.

A.2 USB Mass Storage Testing

The USB mass storage device testing is done to verify if there are any failures when reading from or writing to the device. It includes a regression test, which transfers data to the USB Mass Storage device, reads back the data, and compares to check data integrity issues. The codes for Windows based systems and Linux based systems are different.

Refer to the USB Mass Storage Testing guide on <http://www.cypress.com/?docID=21890> for more information. It is also located in the installed directory at <install directory>\CY3686 NX2LP-FLEX DVK\<ver>\Documentation (assuming default installation).

A.3 Handling SOP Sockets

The NAND Flex DVK board includes eight 48-pin TSOP NAND sockets. These parts are delicate and, therefore, must be handled with care.

The SOP Sockets in this DVK have a positive locking lid design. The lock is attached to the left lid and slides back and forth in a direction parallel to the hinge pins. The sockets are shipped in the locked condition.

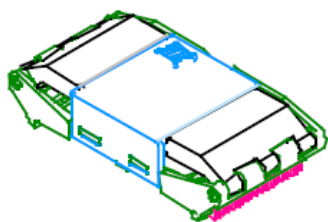

To open them, first slide the lock sideways (approximately 1 mm) to the unlocked position.

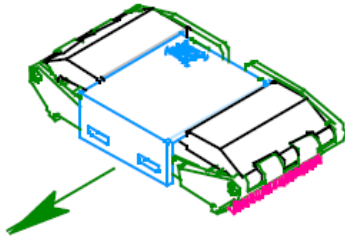

Both lids are now free to be opened by rotating them on their respective hinges.

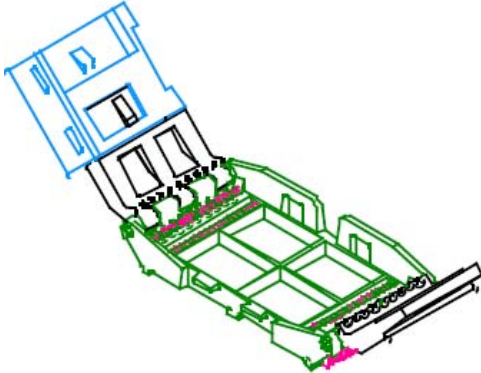

Place the SOP component into the socket.

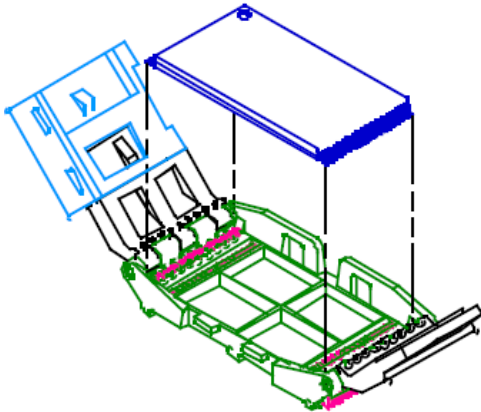

The lids must be closed simultaneously to assure proper seating of the SOP component. If this is not observed, the component shifts to the center of the socket resulting in an unsatisfactory electrical connection. Now, while maintaining a downward pressure on the lock, slide it sideways to it is in a locked position.

A.4 DVK Board Schematics

Figure A-1. FX2LP DVK Board Schematic

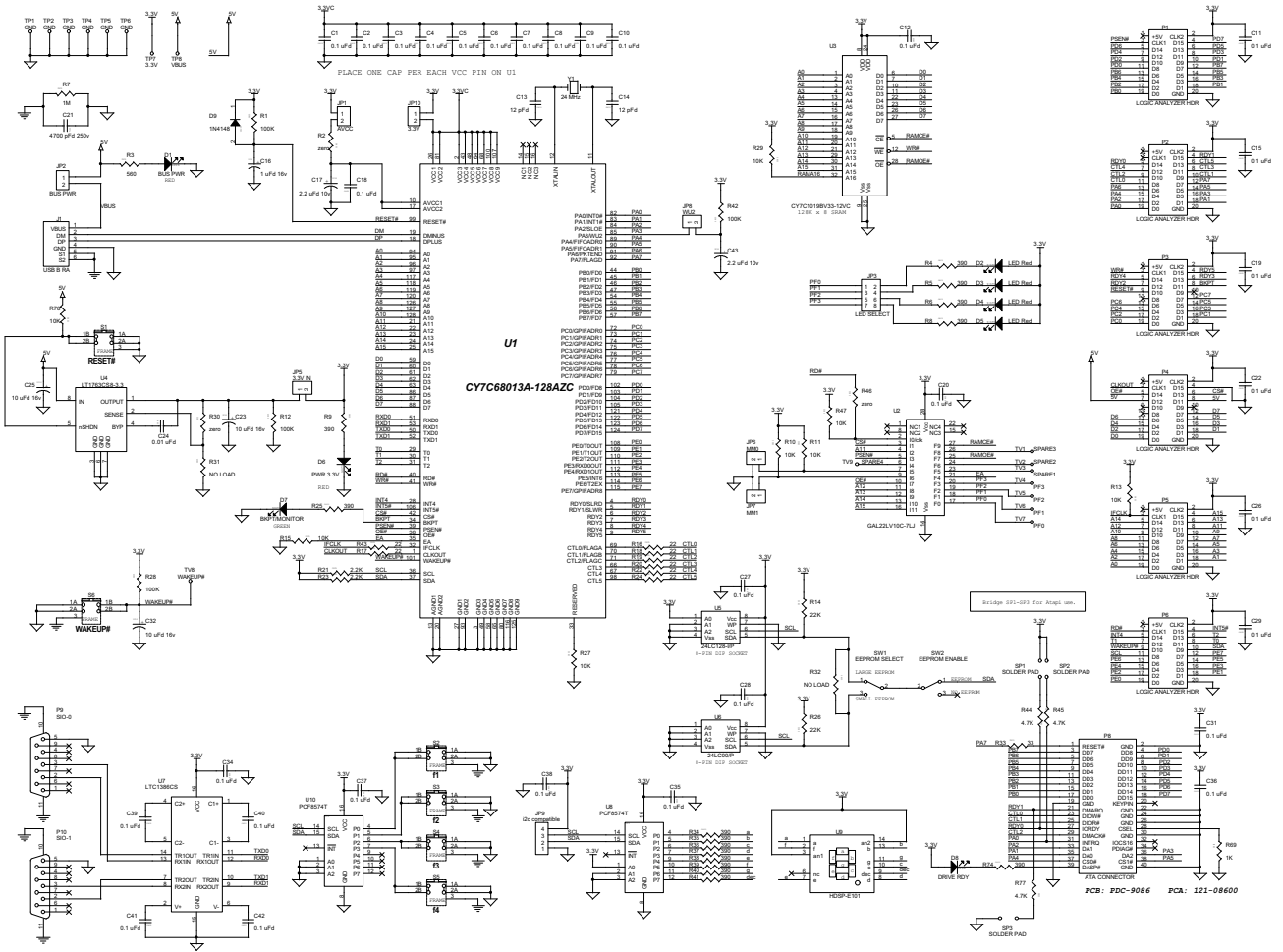
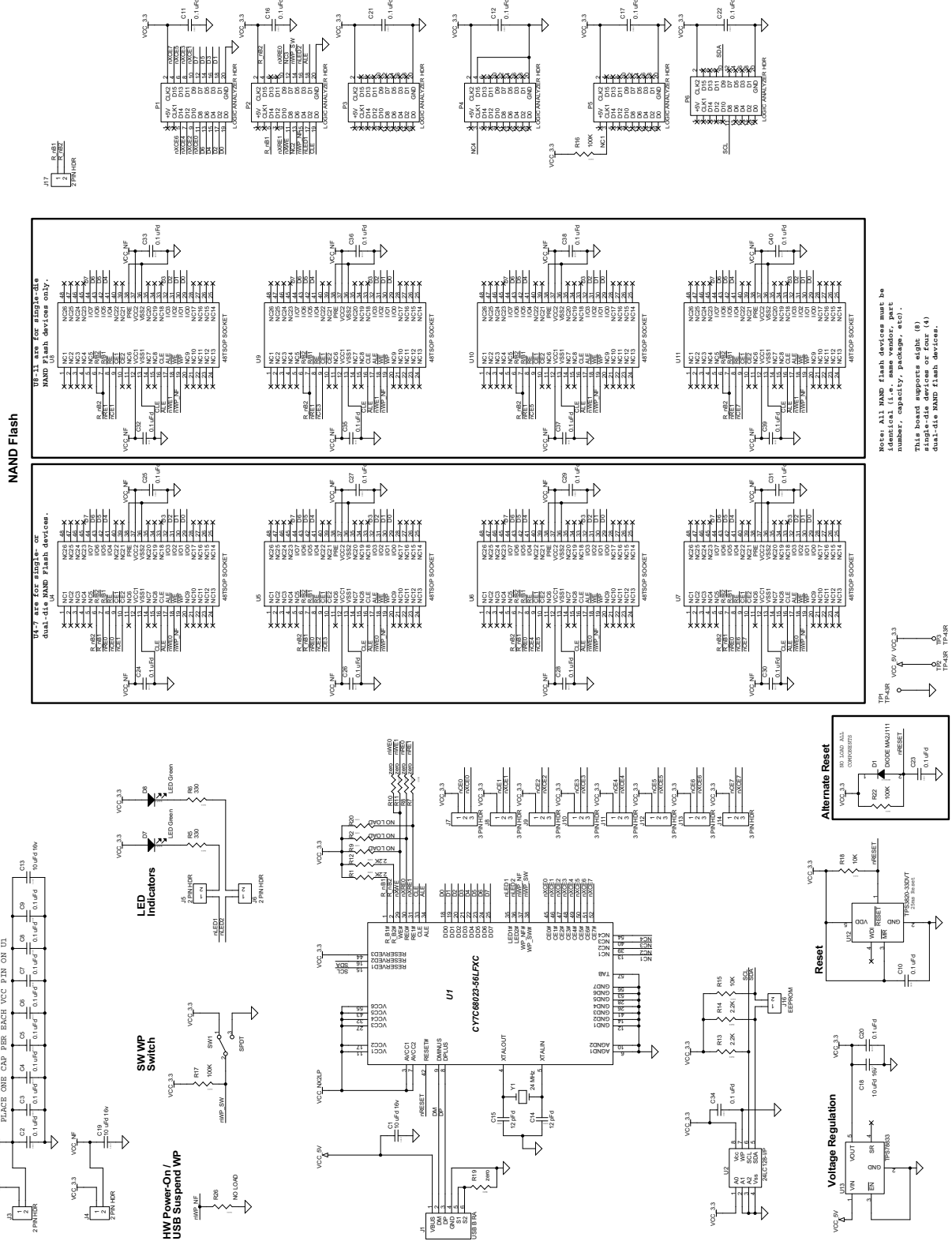
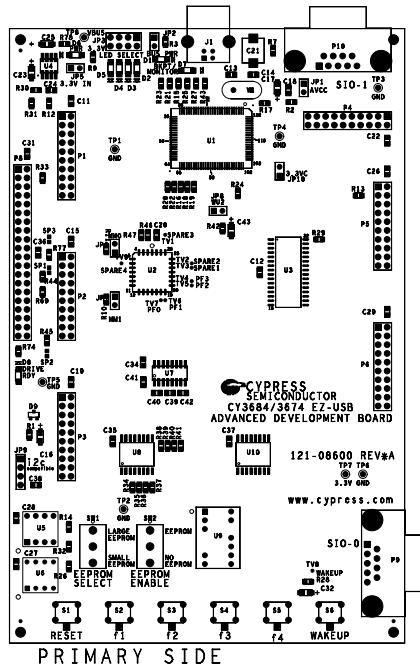

Figure A-2. NX2LP-Flex DVK Board Schematic



A.5 DVK Board Layout

Figure A-3. FX2LP DVK Board Layout



SHUNT PLACEMENT		
REF	DES	PINS
JP1		1-2
JP2		1-2
JP3		1-2
JP3		3-4
JP3		5-6
JP3		7-8
JP5		1-2
JP6		1
JP7		1
JP8		1-2
JP10		1-2

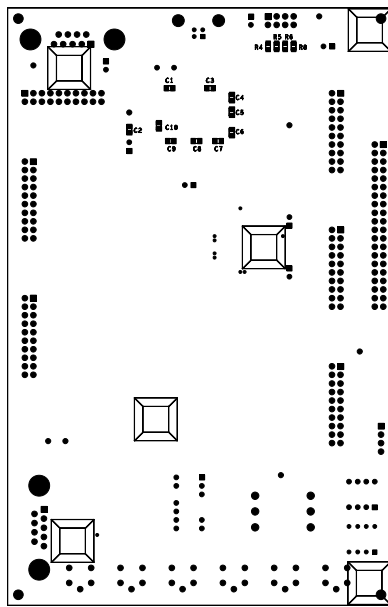

Figure A-4. FX2 Prototype Board Layout

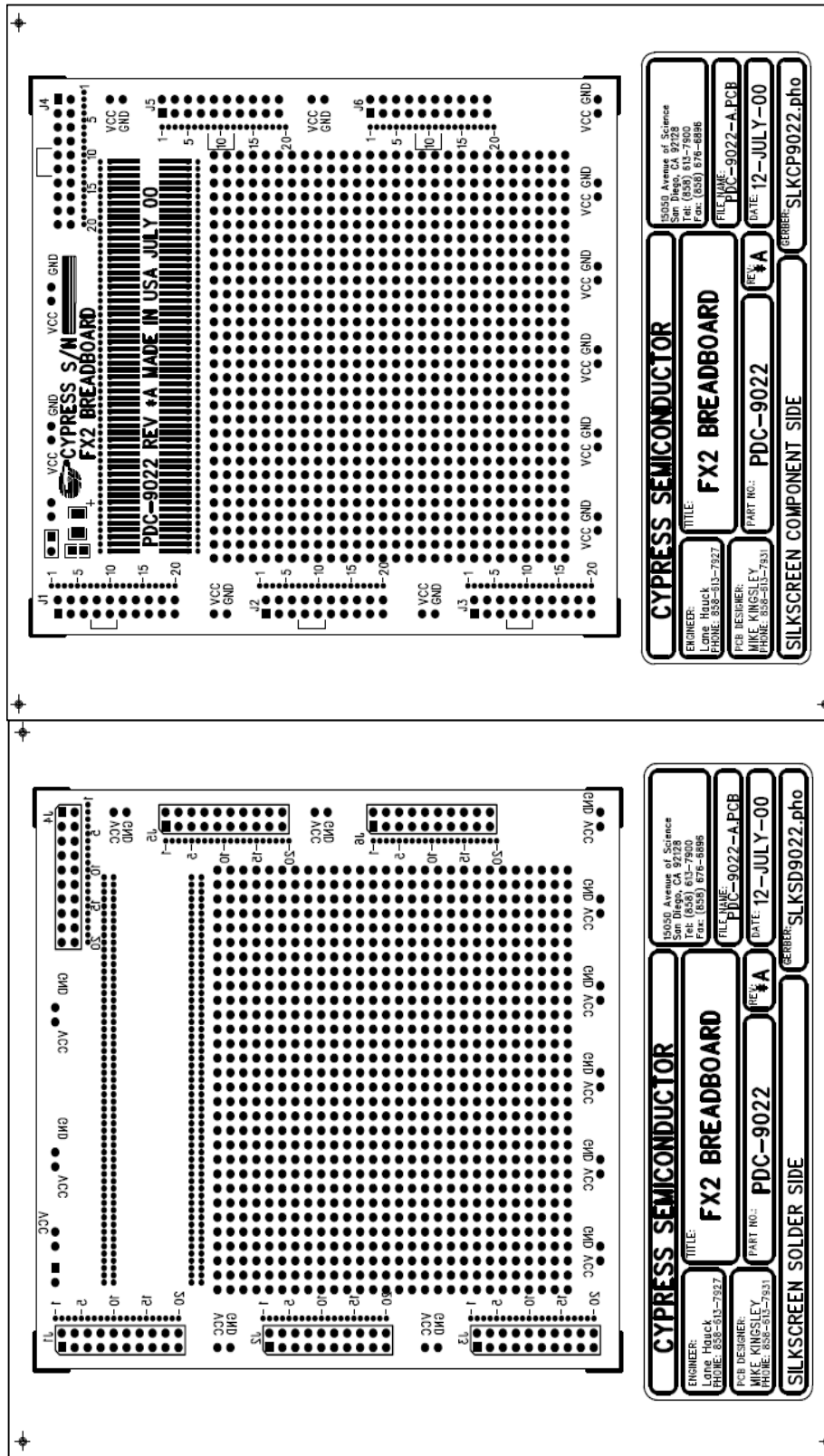
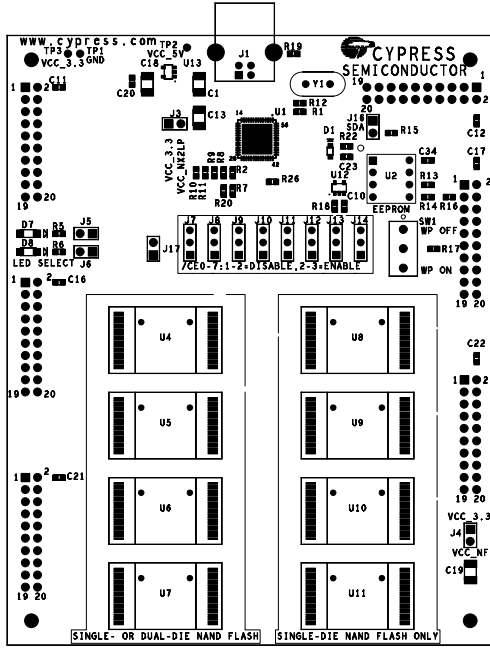
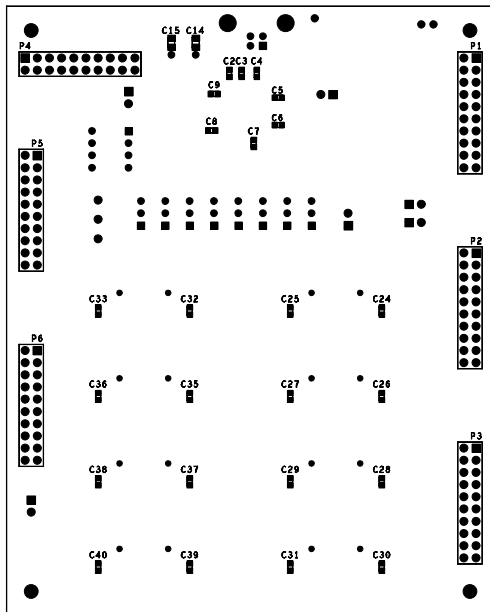

Figure A-5. NX2LP-Flex DVK Board Layout



PRIMARY SIDE



SECONDARY SIDE

A.6 Frequently Asked Questions

Q1: What is the maximum size of the hex file that can be programmed on to the NAND flash using the NX2LP programming utility?

A1: The NX2LP programming utility can only handle hex code files upto 16 KB in size (0x0000 - 0x3FFF), which is the internal RAM boundary of the NX2.

Q2: What does the *default.nx2* file contain?

A2: The *default.nx2* file packages different hex files built off the NX2LP code. The *default.nx2* file provided with the CD or that which is downloaded from the website, packages the hex file for a 512-byte page NAND flash chip and 2-K page NAND flash chip together. So, when the Program Device button is clicked in the NX2LP Programming Utility, upon checking the page size of the NAND flash chip, the pertinent code is downloaded onto the NAND flash chip. You can build your own *.nx2* files using the *buildnx2* application. The NX2 currently supports interface only with 512-byte and 2-K page sizes.

Q3: What is the functionality of the RB pins for the CY7C68023?

A3: The NX2LP has two R/B pins to support a protocol known as "interleave". This allows the NX2LP to work with a different NAND flash chip (or die in a chip) while another is busy. When interleave is not used (almost all cases), both of the R/B signals on the NX2LP need to be tied together so that the proper ready/busy operation is detected.

Q4: If there is an ECC error while reading data from the NAND, how does NX2LP/NX2LP-Flex inform the host about the error?

A4: If there is a ECC error while reading data from the NAND, NX2LP/NX2LP-Flex corrects the error. If it is a correctable error, it corrects the data and then sends the data to the host. If it is an uncorrectable error, it stalls the status phase of the mass storage read request to inform the host that there was an error. In both cases the data is copied to a new block and the old block is marked as a bad block. If there is an ECC error while reading data from the NAND, NX2LP/NX2LP-Flex corrects the error. If it is a correctable error, it corrects the data and then send the data to the host. If it is an uncorrectable error, it stalls the status phase of the mass storage read request to inform the host that there was an error. In both cases, the data will be copied to a new block and the old block will be marked a bad block.

Q5: How do you add new NAND flash parts to NX2LP Using the NX2LP Programming Utility?

A5: NX2LP is currently compatible with SLC NAND flash of 512-byte and 2K-byte page sizes only. The NX2LP Programming Utility needs to know several parameters about the actual NAND chips that are used in the NX2LP memory device. Rather than require entry of these parameters by the user, the utility looks these parameters up in a file called *NandParts.xml*. *NandParts.xml* file can be found in the path `<install directory>\CY3686 NX2LP-FLEX DVK\<ver>\` after the installation of CY3686 EZ-USB NX2LP-Flex Development Kit. If a part is detected that cannot be found in the lookup table, the dialog box added as an attachment pops up. For the NAND parts to function properly with the NX2LP, it is crucial to set the parameters in the dialog accurately. The Manufacturer ID and the Product ID are values that the NX2LP retrieved from the NAND parts themselves. When the Save button is clicked, the parameters are saved in a second lookup table called *OtherParts.xml*. This table is always searched first, before *NandParts.xml*, when the utility tries to identify a part. After the details have been entered and saved, the new NAND flash part will have been added to NX2LP and will be identified automatically when connected the next time.

Q6: How do you modify the parameters of a NAND flash part previously added to NX2LP?

A6: The files, *OtherParts.xml* and *NandParts.xml*, act as lookup tables to retrieve the information of a previously added NAND flash parts. Both these files can be found in the path `<install directory>\CY3686 NX2LP-FLEX DVK\<ver>\` after the installation of the CY3686 EZ-USB NX2LP-

Flex Development Kit. If the particular NAND flash part is present in the file, it shows up on the NX2LP programming utility. If a part that cannot be found in the lookup table is detected, the "Add New Nand Part" dialog box pops up. For the NAND parts to function properly with the NX2LP, it is crucial to set the parameters in the dialog accurately. After entering the parameters from the data-sheet correctly click on save. When the Save button is clicked, the parameters are saved in *OtherParts.xml*.

The parameters of NAND flash need to be modified if they have been wrongly entered the first time altering the memory density of the particular NAND flash part. Once the parameters are entered, the next time the device is connected to USB, it shows up with the same wrong memory density in the NX2LP programming utility. To modify the parameters, follow these steps:

- Right click on *OtherParts.xml* and select **Open with WordPad** option.
- Select the particular entry for the NAND flash part whose parameters have to be re-entered and delete it.
- Save the *OtherParts.xml* file after deleting the particular line and reset the NX2LP board.
- Open the NX2LP programming utility and the "Add New Nand Part" dialog box opens since the Nand Part cannot be found in the lookup table.
- Enter the parameters correctly and click **Save** to create a new entry in the *OtherParts.xml* file with the updated parameters.

Q7: FAT32 Formatting fails when I click on Program device in the NX2LP Programming Utility. What do I do to avoid successfully program the device.

A7: Check the following steps if using the CY3686 EZ-USB NX2LP-Flex Development Kit.

1. Reset the board, it should enumerate as an EEPROM missing device with PID of 8613.
2. Now, you can open the EZ-USB interface and download the bootloader hex file onto the large EEPROM. On resetting the board it should enumerate as a bootloader with PID of 6823.
3. Now you can disconnect the device, and then open the NX2LP programming utility.
4. Once you open the utility, reconnect the device.
5. If the NAND flash is not part of *NAND Parts.xml*, then enter the NAND flash details in the pop-up box that comes up.
6. You can now see that it is connected to NX2LP Unprogrammed with a PID of 4617. Now, if you click the Program Device button, it works fine.

After checking this, if you still have the same problem then ensure that you have disabled the Auto-program option. This ensures the file you are pointing to is the file that is downloaded to the flash. Then, try programming the flash after erasing all its contents using Ctrl+W. Sometimes, when this happens, just erasing the flash and reprogramming it usually works. If your device is being identified, but programming fails, then it mostly points to an error in the bootloader, that is, the *default.nx2* file. Ensure that you point to the correct *.nx2* file.

Check if the pins of the flash are all fine, as even that can cause a download failure at times.

You can obtain the bootloader hex file and the *.nx2* file from CY3686 EZ-USB NX2LP-Flex DVK contents, either with the CD/DVD or you can download it from the [website](#).

Q8: Why does the chip capacity reported by the utility not match with the device capacity seen in Mass storage drive properties, even after the device has been formatted?

A8: NX2LP firmware needs to implement wear leveling (causing the logical to physical translation). To do this, it exposes only 1000 logical blocks per 1024 physical blocks. The firmware internally organizes the NAND Flash into zones. Each zone is 1024 blocks. Only 1000 blocks can be used from each zone for storing data at a time to implement the wear-leveling. Based on this architecture,

we can calculate the logical reported size of the disk for a 512-MB NAND with 2K page size (assumption is 64 pages per block).

NandMfg.exe calculates the physical size of the device as 2048B (bytes per page) * 64 (pages per block) * 1024 (physical blocks per zone) * 4 (zones) = 512MB (M = 1024 * 1024). The firmware reports the logical size of the device to the OS as 2048B (bytes per page) * 64 (pages per block) * 1000 (logical blocks per zone) * 4 (zones) = 500MB (M = 1024 * 1024) = 512000KB (512MB in marketing terminology).

So, when you see 499 MB in the OS, this is expected as some space used up by the file system formatting is never reported.

Q9: Why does the NandMfg.exe utility get stuck when the status reads 'Identifying device...'? ?

A9: The user needs to choose appropriate configuration if not selected already before resetting the DVK or plugging in the DVK. Erase action is initiated from the *NandMfg.exe* as a simple vendor command implemented in the firmware. So it is important for this firmware to be correct as to the one selected in the *NandMfg.exe* (Help > About).

When there is no firmware stored on the NAND Flash, or if there is no NAND Flash connected, the configuration selected (shown in Help->About) will be downloaded to the FX RAM (there was a hard coded bootloader to do this on NX2LP Li-ROM and for NX2LP-Flex this bootloader sits on the I2C EEPROM of FX2LP DVK board). Now, this firmware will perform all actions as directed by the user via *NandMfg.exe*.