

Features

- 2.4-GHz direct sequence spread spectrum (DSSS) radio transceiver
- Operates in the unlicensed worldwide industrial, scientific, and medical (ISM) band (2.400 GHz to 2.483 GHz)
- 21-mA operating current (transmit at -5 dBm)
- Transmit power up to +4 dBm
- Receive sensitivity up to -97 dBm
- Sleep current less than 1 μ A
- DSSS data rates up to 250 kbps, Gaussian frequency-shift keying (GFSK) data rate of 1 Mbps
- Low external component count
- Auto transaction sequencer (ATS) - no MCU intervention
- Framing, length, CRC16, and auto acknowledge (ACK)
- Power management unit (PMU) for MCU
- Fast startup and fast channel changes
- Separate 16 byte transmit and receive FIFOs
- Dynamic data rate reception
- Receive signal strength indication (RSSI)
- Serial peripheral interface (SPI) control while in sleep mode
- 4-MHz SPI microcontroller interface
- Battery voltage monitoring circuitry
- Supports coin-cell operated applications

- Operating voltage from 1.8 V to 3.6 V
- Operating temperature from 0 °C to 70 °C
- Space saving 40-pin QFN 6 x 6 mm package

Applications

- Wireless sensor networks
- Wireless actuator control
- Home automation
- White goods
- Commercial building automation
- Automatic meter readers
- Precision agriculture
- Remote controls
- Consumer electronics
- Personal health and fitness
- Toys

Applications Support

The CYRF7936 CyFi™ transceiver is a radio IC designed for low power embedded wireless applications. It can be used only with Cypress's PSoC programmable system-on-chip. Combined with the PSoC and a CyFi network protocol stack, CYRF7936 can be used to implement a complete CyFi wireless system.

See www.cypress.com for development tools, reference designs, and application notes.

Logic Block Diagram

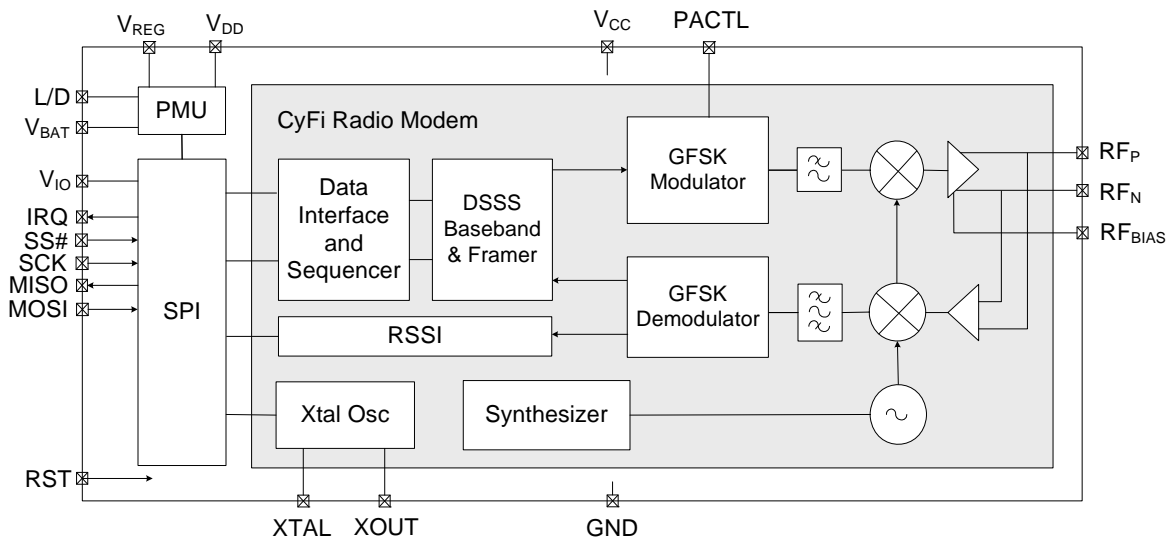

Contents

Pinouts	3	Operating Conditions	13
Functional Overview	4	DC Characteristics	13
Data Transmission Modes	4	AC Characteristics	14
Packet Framing	4	RF Characteristics	15
Packet Buffers	5	Typical Operating Characteristics	17
Auto Transaction Sequencer (ATS)	5	Ordering Information	19
Data Rates	5	Ordering Code Definitions	19
Functional Block Overview	6	Package Description	20
2.4-GHz CyFi Radio Modem	6	Acronyms	21
Frequency Synthesizer	6	Document Conventions	21
Baseband and Framer	6	Units of Measure	21
Packet Buffers and Radio Configuration Registers	6	Document History Page	22
SPI Interface	6	Sales, Solutions, and Legal Information	23
Interrupts	8	Worldwide Sales and Design Support	23
Clocks	8	Products	23
Power Management	8	PSoC® Solutions	23
Receiver Front End	8	Cypress Developer Community	23
Receive Spurious Response	9	Technical Support	23
Application Examples	9		
Absolute Maximum Ratings	13		

Pinouts

Figure 1. Pin Diagram - CYRF7936 40-Pin QFN

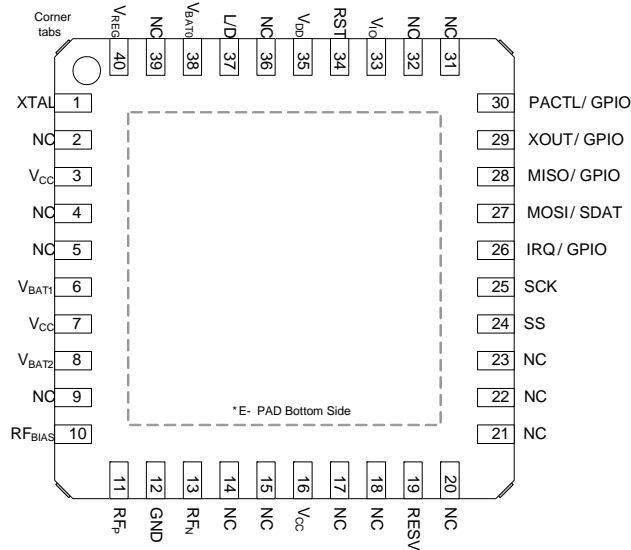

Table 1. Pin Description - CYRF7936 40-Pin QFN

Pin Number	Name	Type	Default	Description
1	XTAL	I	I	12-MHz crystal
2, 4, 5, 9, 14, 15, 17, 18, 20, 21, 22, 23, 31, 32, 36, 39	NC	NC		Connect to GND
3, 7, 16	V _{CC}	Pwr		V _{CC} = 2.4 V to 3.6 V. Typically connected to V _{REG} .
6, 8, 38	V _{BAT(0-2)}	Pwr		V _{BAT} = 1.8 V to 3.6 V. Main supply.
10	RF _{BIAS}	O	O	RF I/O 1.8 V reference voltage
11	RF _P	I/O	I	Differential RF signal to and from antenna
12	GND	GND		Ground
13	RF _N	I/O	I	Differential RF signal to and from antenna
19	RESV	I		Must be connected to GND
24	SS#	I	I	SPI enable, active LOW assertion. Enables and frames transfers.
25	SCK	I	I	SPI clock
26	IRQ	I/O	O	Interrupt output (configurable active HIGH or LOW), or GPIO
27	MOSI	I/O	I	SPI data input pin master out slave in (MOSI) or serial data (SDAT)
28	MISO	I/O	Z	SPI data output pin - master in slave out (MISO), or GPIO (in SPI 3-pin mode). Tristates when SPI 3PIN = 0 and SS# is deasserted.
29	XOUT	I/O	O	Buffered 0.75, 1.5, 3, 6, or 12 MHz clock, $\overline{\text{PACTL}}$, or GPIO. Tristates in sleep mode (configure as GPIO drive LOW).
30	PACTL	I/O	O	Control signal for external PA, T/R switch, or GPIO
33	V _{IO}	Pwr		I/O interface voltage, 1.8 V to 3.6 V
34	RST	I	I	Device reset. Internal 10-k Ω pull-down resistor. Active HIGH, typically connect through a 0.47- μ F capacitor to V _{BAT} . Must have RST = 1 event the first time power is applied to the radio. Otherwise, the radio control register state is unknown.
35	V _{DD}	Pwr		Decoupling pin for 1.8 V logic regulator, connect through a 0.47- μ F capacitor to GND.

Table 1. Pin Description - CYRF7936 40-Pin QFN (continued)

Pin Number	Name	Type	Default	Description
37	LVD	O		PMU inductor or diode connection, when used. If not used, connect to GND.
40	V _{REG}	Pwr		PMU boosted output voltage feedback
E-pad	GND	GND		Must be soldered to ground
Corner tabs	NC	NC		Do not solder the tabs and keep other signal traces clear. All tabs are common to the lead frame or paddle, which is grounded after the pad is grounded. While they are visible to the user, they do not extend to the bottom.

Functional Overview

The CYRF7936 IC is designed to implement wireless device links operating in the worldwide 2.4-GHz ISM frequency band. It is intended for systems compliant with worldwide regulations covered by ETSI EN 301 489-1 V1.41, ETSI EN 300 328-1 V1.3.1 (Europe), FCC CFR 47 Part 15 (USA and Industry Canada), and TELEC ARIB_T66_March, 2003 (Japan).

The CYRF7936 contains a 2.4-GHz CyFi radio modem, which features a 1-Mbps GFSK radio front-end, packet data buffering, packet framer, DSSS baseband controller, and RSSI. CYRF7936 features a SPI interface for data transfer and device configuration.

The CyFi radio modem supports 98 discrete 1-MHz channels (regulations may limit the use of some of these channels in certain jurisdictions).

The baseband performs DSSS spreading and despreading, start-of-packet (SOP), end-of-packet (EOP) detection, and CRC16 generation and checking. The baseband may also be configured to automatically transmit ACK handshake packets whenever a valid packet is received.

When in receive mode, with packet framing enabled, the device is always ready to receive data transmitted at any of the supported bit rates. This enables the implementation of mixed-rate systems in which different devices use different data rates. This also enables the implementation of dynamic data rate systems that use high data rates at shorter distances or in a low-moderate interference environment or both. It changes to lower data rates at longer distances or in high interference environments or both.

In addition, the CYRF7936 IC has a power management unit (PMU), which allows direct connection of the device to any battery voltage in the range 1.8 V to 3.6 V. The PMU conditions the battery voltage to provide the supply voltages required by the device, and may supply external devices.

Data Transmission Modes

The CyFi radio transceiver supports two different data transmission modes:

- In GFSK mode, data is transmitted at 1 Mbps, without any DSSS.
- In 8DR mode, DSSS is enabled and eight bits are encoded in each derived code symbol transmitted.

Both 64 chip and 32 chip pseudo noise (PN) codes are supported in 8DR mode. In general, lower data rates reduce packet error rate in any given environment.

Packet Framing

The CYRF7936 IC device supports the following data packet framing features:

SOP

Packets begin with a two-symbol SOP marker. The SOP_CODE_ADR PN code used for the SOP is different from that used for the “body” of the packet, and if necessary may be a different length. SOP must be configured to be the same length on both sides of the link.

Length

This is the first eight bits after the SOP symbol and is transmitted at the payload data rate. An EOP condition is inferred after reception of the number of bytes defined in the length field, plus two bytes for the CRC16.

CRC16

The device may be configured to append a 16-bit CRC16 to each packet. The CRC16 uses the USB CRC polynomial with the added programmability of the seed. If enabled, the receiver verifies the calculated CRC16 for the payload data against the received value in the CRC16 field. The seed value for the CRC16 calculation is configurable, and the CRC16 transmitted may be calculated using either the loaded seed value or a zero seed. The received data CRC16 is checked against both the configured and zero CRC16 seeds.

CRC16 detects the following errors:

- Any one bit in error.
- Any two bits in error (irrespective of how far apart, which column, and so on).
- Any odd number of bits in error (irrespective of the location).
- An error burst as wide as the checksum itself.

Figure 2 shows an example packet with SOP, CRC16, and lengths fields enabled and Figure 3 shows a standard ACK packet.

Figure 2. Example Packet Format

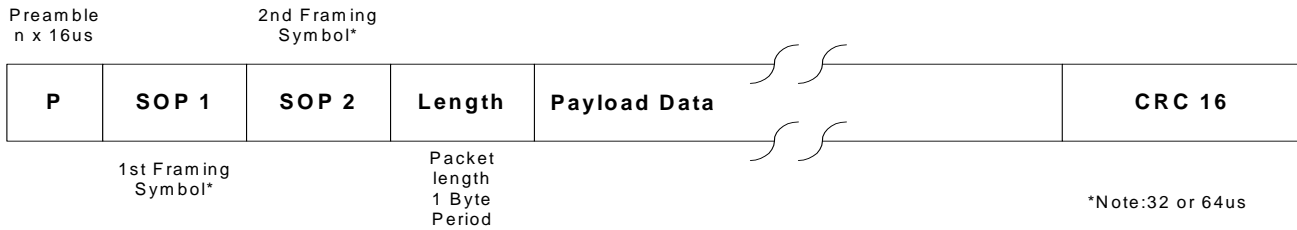
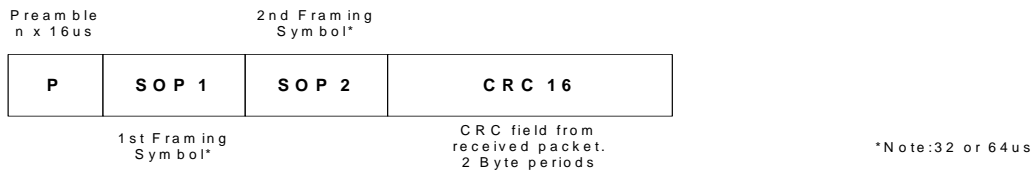

Figure 3. Example ACK Packet Format



Packet Buffers

All data transmission and reception use the 16-byte packet buffers: one for transmission and one for reception.

The transmit buffer allows loading a complete packet of up to 16 bytes of payload data in one burst SPI transaction. This is then transmitted with no further MCU intervention. Similarly, the receive buffer allows receiving an entire packet of payload data up to 16 bytes with no firmware intervention required until the packet reception is complete.

Maximum packet length depends on the accuracy of the clock on each end of the link. Packet lengths up to 40 bytes are supported when the delta between the transmitter and receiver crystals is 60 ppm or better. Interrupts are provided to allow an MCU to use the transmit and receive buffers as FIFOs. When transmitting a packet longer than 16 bytes, the MCU can load 16 bytes initially, and add further bytes to the transmit buffer as transmission of data creates space in the buffer. Similarly, when receiving packets longer than 16 bytes, the MCU must fetch received data from the FIFO periodically during packet reception to prevent it from overflowing.

Auto Transaction Sequencer (ATS)

The CYRF7936 IC provides automated support for transmission and reception of acknowledged data packets.

When transmitting in transaction mode, the device automatically:

- Starts the crystal and synthesizer
- Enters transmit mode
- Transmits the packet in the transmit buffer
- Transitions to receive mode and waits for an ACK packet
- Transitions to the transaction end state when an ACK packet is received or a timeout period expires

Similarly, when receiving in transaction mode, the device automatically:

- Waits in receive mode for a valid packet to be received
- Transitions to transmit mode, transmits an ACK packet
- Transitions to the transaction end state (receive mode to await the next packet, and so on.)

The contents of the packet buffers are not affected by the transmission or reception of ACK packets.

In each case, the entire packet transaction takes place without any need for MCU firmware action (as long as packets of 16 bytes or less are used). To transmit data, the MCU must load the data packet to be transmitted, set the length, and set the TX GO bit. Similarly, when receiving packets in transaction mode, firmware must retrieve the fully received packet in response to an interrupt request indicating reception of a packet.

Data Rates

The CYRF7936 IC supports the following data rates by combining the PN code lengths and data transmission modes described in the previous sections:

- 1000 kbps (GFSK)
- 250 kbps (32 chip 8DR)
- 125 kbps (64 chip 8DR)

Functional Block Overview

2.4-GHz CyFi Radio Modem

The CyFi radio modem is a dual conversion low IF architecture optimized for power, range, and robustness. The CyFi radio modem employs channel-matched filters to achieve high performance in the presence of interference. An integrated power amplifier (PA) provides up to +4 dBm transmit power, with an output power control range of 34 dB in seven steps. The supply current of the device is reduced as the RF output power is reduced.

Table 2. Internal PA Output Power Step Table

PA Setting	Typical Output Power (dBm)
7	+4
6	0
5	-5
4	-13
3	-18
2	-24
1	-30
0	-35

Frequency Synthesizer

Prior to transmission or reception, the frequency synthesizer must settle. The settling time varies depending on the channel; 25 fast channels are provided with a maximum settling time of 100 μ s.

The 'fast channels' (less than 100 μ s settling time) are every third channel, starting at 0 up to and including 72 (for example, 0, 3, 6, 9 69, 72).

Baseband and Framer

The baseband and framer blocks provide the DSSS encoding and decoding, SOP generation and reception, CRC16 generation and checking, and EOP detection and length field.

Packet Buffers and Radio Configuration Registers

Packet data and configuration registers are accessed through the SPI interface. All configuration registers are directly addressed through the address field in the SPI packet. Configuration registers allow configuration of DSSS PN codes, data rate, operating mode, interrupt masks, interrupt status, and so on.

SPI Interface

The CYRF7936 IC has an SPI interface supporting communication between an application MCU and one or more slave devices (including the CYRF7936). The SPI interface supports single-byte and multi-byte serial transfers using either 4-pin or 3-pin interfacing. The SPI communications interface consists of slave select (SS#), serial clock (SCK), MOSI, MISO, or SDAT.

SPI communication is described as follows:

- Command direction (bit 7) = '1' enables SPI write transaction. When it equals a '0', it enables SPI read transactions.
- Command increment (bit 6) = '1' enables SPI auto address increment. When set, the address field automatically increments at the end of each data byte in a burst access. Otherwise the same address is accessed.
- Six bits of address
- Eight bits of data

The device receives SCK from an application MCU on the SCK pin. Data from the application MCU is shifted in on the MOSI pin. Data to the application MCU is shifted out on the MISO pin. The active LOW SS# pin must be asserted to initiate an SPI transfer.

The application MCU can initiate SPI data transfers using a multibyte transaction. The first byte is the Command/Address byte and the following bytes are the data bytes as shown in [Table 3](#) through [Figure 6 on page 7](#).

The SPI communications interface has a burst mechanism, where the first byte can be followed by as many data bytes as required. A burst transaction is terminated by deasserting the slave select (SS# = 1).

The SPI communications interface single read and burst read sequences are shown in [Figure 4](#) and [Figure 5 on page 7](#), respectively.

The SPI communications interface single write and burst write sequences are shown in [Figure 6](#) and [Figure 7 on page 7](#), respectively.

This interface may be optionally operated in a 3-pin mode with the MISO and MOSI functions combined in a single bidirectional data pin (SDAT). When using the 3-pin mode, firmware must ensure that the MOSI pin on the MCU is in a high-impedance state except when MOSI is actively transmitting data.

The device registers may be written to or read from one byte at a time, or several sequential register locations may be written or read in a single SPI transaction using incrementing burst mode. In addition to single byte configuration registers, the device includes register files. Register files are FIFOs written to and read from using nonincrementing burst SPI transactions.

The IRQ pin function may be optionally multiplexed to the MOSI pin. When this option is enabled, the IRQ function is not available while the SS# pin is LOW. When using this configuration, firmware must ensure that the MOSI pin on the MCU is in a high impedance state whenever the SS# pin is HIGH.

The SPI interface is not dependent on the internal 12 MHz clock. Registers may therefore be read from or written to when the device is in sleep mode, and the 12 MHz oscillator disabled.

The SPI interface and the IRQ and RST pins have a separate voltage reference pin (V_{IO}). This enables the device to interface directly to MCUs operating at voltages below the CYRF7936 IC supply voltage.

Table 3. SPI Transaction Format

Parameter	Byte 1			Byte 1+N
Bit #	7	6	[5:0]	[7:0]
Bit Name	DIR	INC	Address	Data

Figure 4. SPI Single Read Sequence

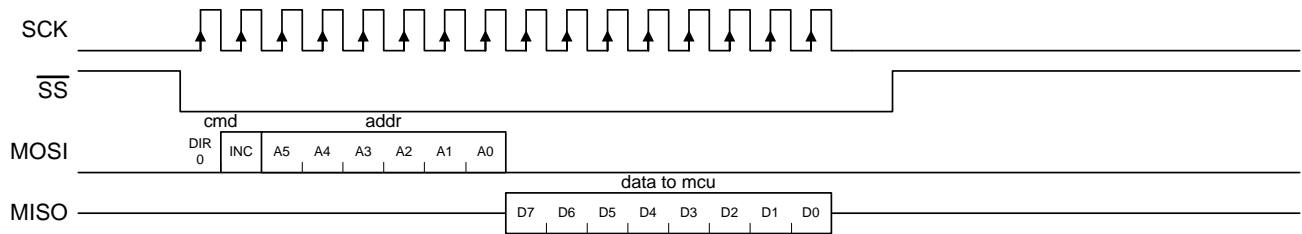

Figure 5. SPI Incrementing Burst Read Sequence

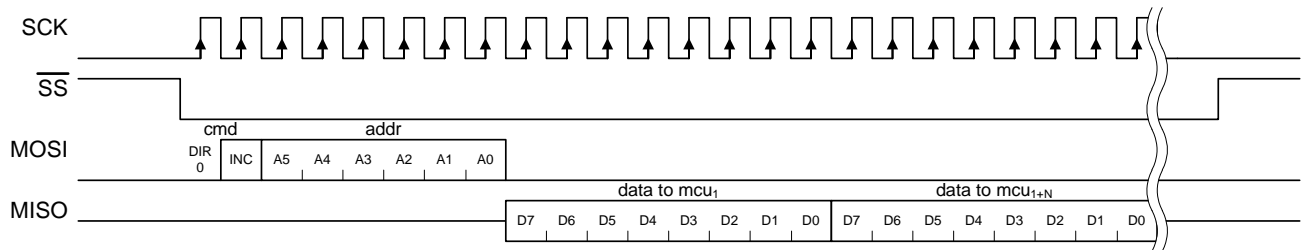

Figure 6. SPI Single Write Sequence

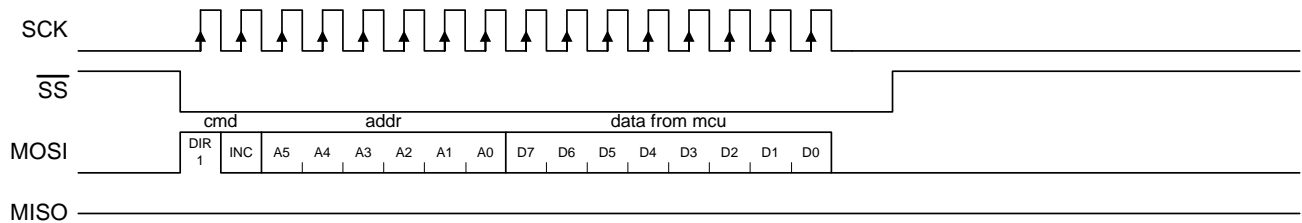
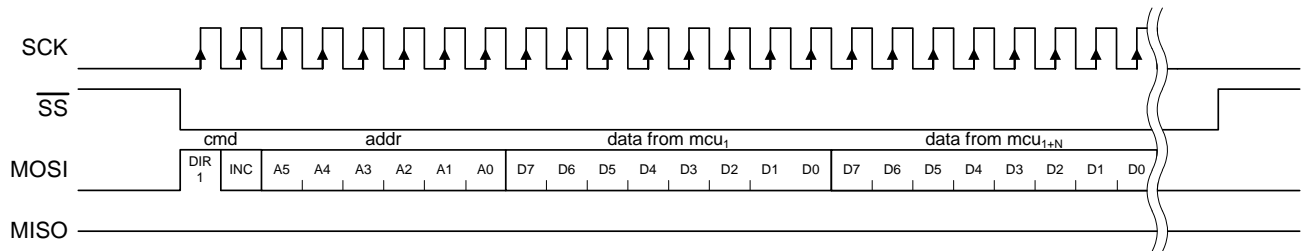

Figure 7. SPI Incrementing Burst Write Sequence



Interrupts

The device provides an interrupt (IRQ) output, which is configurable to indicate the occurrence of different events. The IRQ pin can be programmed to be either active HIGH or active LOW; it can be a CMOS or open drain output.

The CYRF7936 IC features three sets of interrupts: transmit, receive, and system interrupts. These interrupts all share a single pin (IRQ), but can be independently enabled or disabled. The contents of the enable registers are preserved when switching between transmit and receive modes.

If more than one interrupt is enabled at any time, it is necessary to read the relevant status register to determine which event caused the IRQ pin to assert. Even when a given interrupt source is disabled, the status of the condition that otherwise causes an interrupt can be determined by reading the appropriate status register. It is therefore possible to use devices without the IRQ pin, by polling the status registers to wait for an event, rather than using the IRQ pin.

Clocks

A 12-MHz crystal (30 ppm or better) is directly connected between XTAL and GND without the need for external capacitors. A digital clock out function is provided, with selectable output frequencies of 0.75, 1.5, 3, 6, or 12 MHz. This output may be used to clock an external microcontroller (MCU) or ASIC. This output is enabled by default, but may be disabled.

The requirements to directly connect the crystal to the XTAL pin and GND are:

- Nominal frequency: 12 MHz
- Operating mode: Fundamental mode
- Resonance mode: Parallel resonant
- Frequency stability: ± 30 ppm
- Series resistance: $\leq 60 \Omega$
- Load capacitance: 10 pF
- Drive level: 100 μ W

Power Management

The operating voltage of the device is 1.8 V to 3.6 V DC, which is applied to the V_{BAT} pin. The device can be shut down to a fully static sleep mode by writing to the FRC END = 1 and END STATE = 000 bits in the XACT_CFG_ADR register over the SPI interface. The device enters sleep mode within 35 μ s after the last SCK positive edge at the end of this SPI transaction. Alternatively, the device may be configured to automatically enter sleep mode after completing the packet transmission or reception. When in sleep mode, the on-chip oscillator is stopped, but the SPI interface remains functional. The device wakes from sleep mode automatically when the device is commanded to enter transmit or receive mode. When resuming from sleep mode, there is a short delay while the oscillator restarts. The device can be configured to assert the IRQ pin when the oscillator has stabilized.

The output voltage (V_{REG}) of the PMU is configurable to several minimum values between 2.4 V and 2.7 V. V_{REG} may be used to provide up to 15 mA (average load) to external devices. It is possible to disable the PMU and provide an externally regulated DC supply voltage to the device's main supply in the range 2.4 V to 3.6 V. The PMU also provides a regulated 1.8 V supply to the logic.

The PMU is designed to provide high boost efficiency (74%–85% depending on input voltage, output voltage, and load) when using a Schottky diode and power inductor. This eliminates the need for an external boost converter in many systems where other components require a boosted voltage. However, reasonable efficiencies (69%–82% depending on input voltage, output voltage, and load) can be achieved when using low cost components such as SOT23 diodes and 0805 inductors.

The current through the diode must stay within the linear operating range of the diode. For some loads the SOT23 diode is sufficient, but with higher loads it is not; a SS12 diode must be used to stay within this linear range of operation. Along with the diode, the inductor used must not saturate its core. In higher loads, a lower resistance/higher saturation coil such as the inductor from Sumida must be used.

The PMU also provides a configurable low battery detection function, which can be read over the SPI interface. One of seven thresholds between 1.8 V and 2.7 V can be selected. The interrupt pin can be configured to assert when the voltage on the V_{BAT} pin falls below the configured threshold. LV IRQ is not a latched event. Battery monitoring is disabled when the device is in sleep mode.

Receiver Front End

The gain of the receiver can be controlled directly by writing to the low-noise amplifier (LNA) bit and the attenuation (ATT) bit of the RX_CFG_ADR register. Clearing the LNA bit reduces the receiver gain approximately 20 dB, allowing accurate reception of very strong received signals (for example, when operating a receiver very close to the transmitter). Approximately 30 dB of receiver attenuation can be added by setting the ATT bit. This limits data reception to devices at very short ranges. Enabling LNA is recommended, unless receiving from a device using external PA.

When the device is in receive mode, the RSSI_ADR register returns the relative signal strength of the on-channel signal power.

When receiving, the device automatically measures and stores the relative strength of the signal being received as a five bit value. An RSSI reading is taken automatically when the SOP is detected. In addition, a new RSSI reading is taken every time the previous reading is read from the RSSI_ADR register. This allows the background RF energy level on any given channel to be easily measured when RSSI is read while no signal is being received. A new reading can occur as fast as once every 12 μ s.

Receive Spurious Response

The transmitter may exhibit spurs around 50MHz offset at levels approximately 50dB to 60dB below the carrier power. Receivers operating at the transmit spur frequency may receive the spur if the spur level power is greater than the receive sensitivity level.

The workaround for this is to program an additional byte in the packet header which contains the transmitter channel number. After the packet is received, the channel number can be checked. If the channel number does not match the receive channel then the packet is rejected.

Application Examples

Figure 8. Recommended Circuit for Systems where $V_{BAT} \leq 2.4 V$

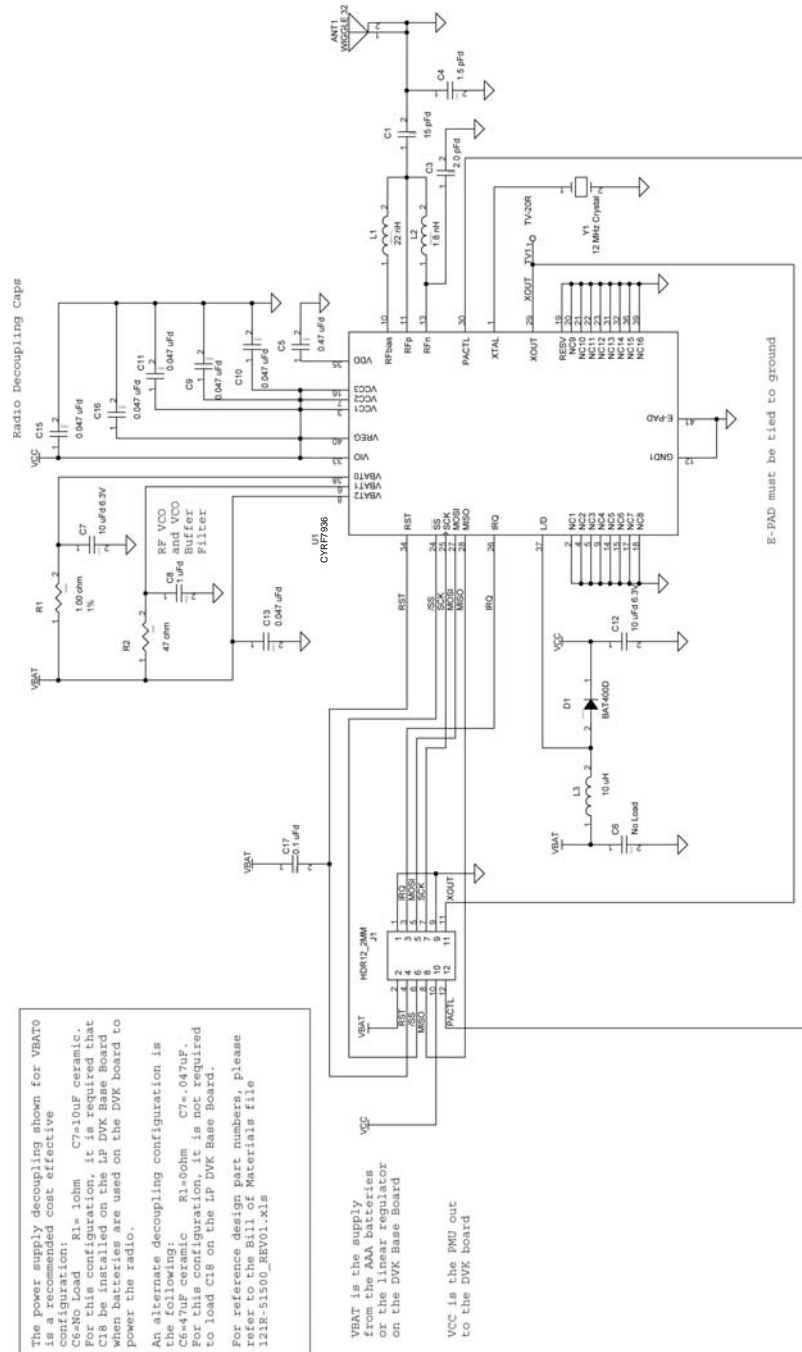

Table 4. Recommended BoM for Systems where $V_{BAT} \leq 2.4 V$

Item	Qty	CY Part Number	Reference	Description	Manufacturer	Mfr Part Number
1	1	NA	ANT1	2.5 GHz H-STUB Wiggle Antenna for 32 MIL PCB	NA	NA
2	1	730-10012	C1	CAP 15 PF 50 V CERAMIC NPO 0402	Panasonic	ECJ-0EC1H150J
3	1	730-11955	C3	CAP 2.0 PF 50 V CERAMIC NPO 0402	Kemet	C0402C209C5GACTU
4	1	730-11398	C4	CAP 1.5PF 50 V CERAMIC NPO 0402 SMD	PANASONIC	ECJ-0EC1H1R5C
5	1	730R-13322	C5	CAP CER.47 uF 6.3 V X5R 0402	Murata	GRM155R60J474KE1 9D
6	2	730-13037	C12,C7	CAP CERAMIC 10 uF 6.3 V X5R 0805	Kemet	C0805C106K9PACTU
7	1	730-13400	C8	CAP 1 uF 6.3 V CERAMIC X5R 0402	Panasonic	ECJ-0EB0J105M
8	6	730-13404	C9,C10,C11, C13,C15,C16	CAP 0.047 uF 50 V CERAMIC X5R 0402	AVX	0402YD473KAT2A
9	1	730R-11952	C17	CAP.10UF 10 V CERAMIC X5R 0402	Kemet	C0402C104K8PACTU
10	1	800-13317	D1	Diode Schottky 0.5A 40 V SOT23	DIODES INC	BAT400D-7-F
11	1	420-11976	J1	CONN HEADER 12 PIN 2MM GOLD	Hirose Electric Co. Ltd.	DF11-12DP-2DSA(01)
12	1	800-13401	L1	INDUCTOR 22NH 2% FIXED 0603 SMD	Panasonic - ECG	ELJ-RE22NGF2
13	1	800-11651	L2	INDUCTOR 1.8NH +/- .3NH FIXED 0402 SMD	Panasonic - ECG	ELJ-RF1N8DF
14	1	800-10594	L3	COIL 10UH 1100MA CHOKE 0805	Newark	30K5421
15	1	630-11356	R1	RES 1.00 OHM 1/8W 1% 0805 SMD	Yageo	9C08052A1R00FKHFT
16	1	610-13402	R2	RES 47 OHM 1/16W 5% 0402 SMD	Panasonic - ECG	ERJ-2GEJ470X
17	1	CYRF7936-40LFXC	U1	IC, LP 2.4 GHz Radio SoC QFN-40	Cypress Semiconductor	CYRF7936-40LFXC
18	1	800-13259	Y1	Crystal 12.00 MHZ HC49 SMD	eCERA	GF-1200008
19	1	PDCR-9515 REV01	PCB	Printed Circuit Board	Cypress Semiconductor	PDCR-9515 REV01
20	1	920-11206	LABEL1	Serial Number		
21	1	920-51500 REV01	LABEL2	PCA #		121R-51500 REV01

Figure 9. Recommended Circuit for Systems where V_{BAT} is 2.4 V to 3.6 V (PMU Disabled)

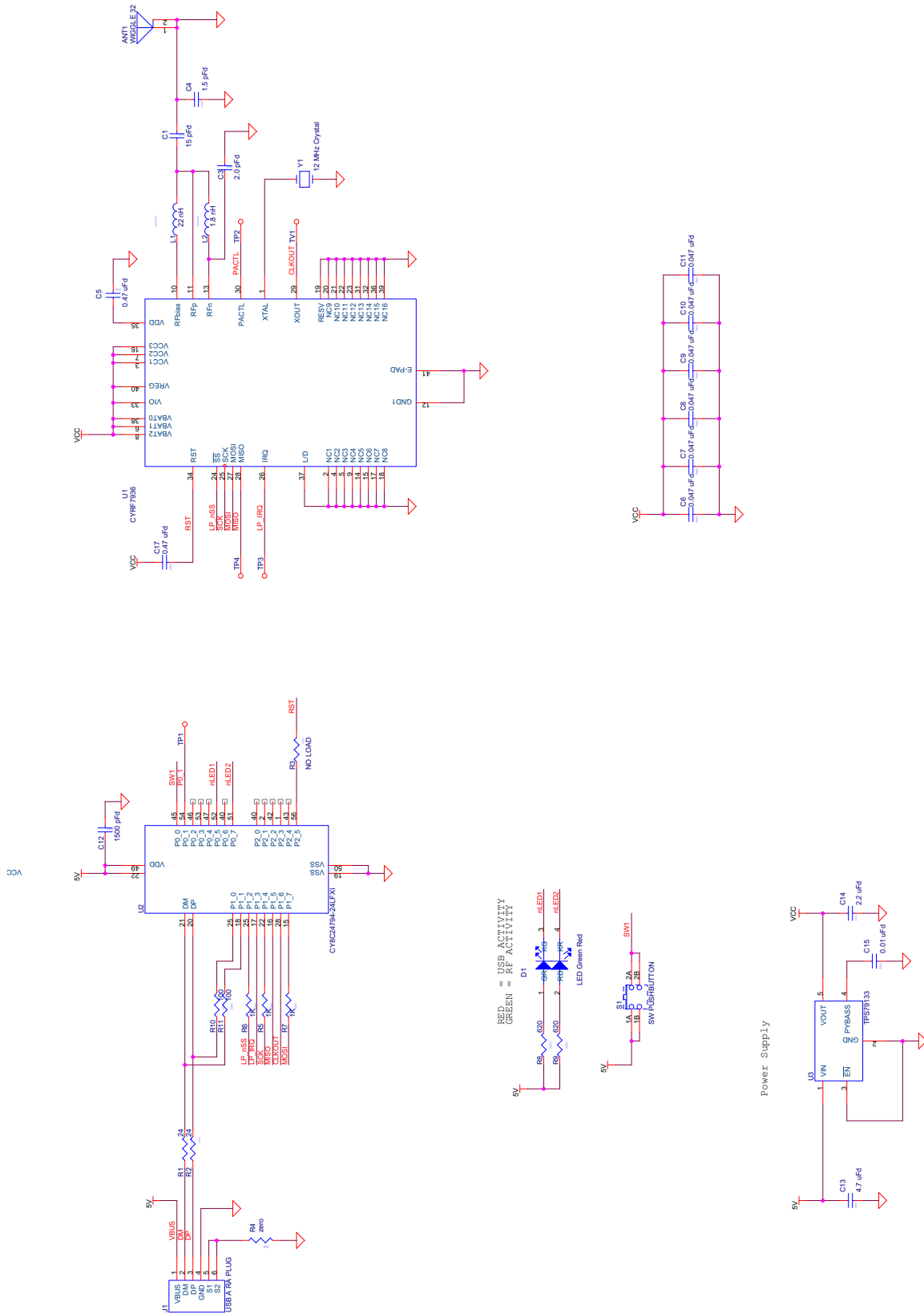

Table 5. Recommended BoM for Systems where V_{BAT} is 2.4 V - 3.6 V (PMU disabled)

Item	Qty	CY Part Number	Reference	Description	Manufacturer	Mfr Part Number
1	1	NA	ANT1	2.5 GHz H-STUB Wiggle Antenna for 32MIL PCB	NA	NA
2	1	730-10012	C1	CAP 15 PF 50 V CERAMIC NPO 0402	Panasonic	ECJ-0EC1H150J
3	1	730-11955	C3	CAP 2.0 PF 50 V CERAMIC NPO 0402	Kemet	C0402C209C5GACTU
4	1	730-11398	C4	CAP 1.5 PF 50 V CERAMIC NPO 0402 SMD	PANASONIC	ECJ-0EC1H1R5C
5	1	730-13322	C5	CAP 0.47 uF 6.3 V CERAMIC X5R 0402	Murata	GRM155R60J474KE19D
6	6	730-13404	C6,C7,C8,C9,C10, C11	CAP 0.047 uF 16 V CERAMIC X5R 0402	AVX	0402YD473KAT2A
7	1	730-11953	C12	CAP 1500PF 50V CERAMIC X7R 0402	Kemet	C0402C152K5RACTU
8	1	730-13040	C13	CAP CERAMIC 4.7UF 6.3V XR5 0805	Kemet	C0805C475K9PACTU
9	1	730-12003	C14	CAP CER 2.2 uF 10 V 10% X7R 0805	Murata Electronics North America	GRM21BR71A225KA01L
10	1	800-13333	D1	LED GREEN/RED BICOLOR 1210 SMD	LITEON	LTST-C155KGJRKT
11	1	420-13046	J1	CONN USB PLUG TYPE A PCB SMT	ACON	UAR72-4N5J10
12	1	800-13401	L1	INDUCTOR 22NH 2% FIXED 0603 SMD	Panasonic - ECG	ELJ-RE22NGF2
13	1	800-11651	L2	INDUCTOR 1.8NH +/- .3NH FIXED 0402 SMD	Panasonic - ECG	ELJ-RF1N8DF
14	2	610-10037	R1, R2	RES 24 OHM 1/16W 5% 0603 SMD	Panasonic - ECG	ERJ-3GEYJ240V
15	1	610-10343	R4	RES ZERO OHM 1/16W 0402 SMD	Panasonic - ECG	ERJ-2GE0R00X
16	3	610-10016	R5, R6, R7	RES CHIP 1K OHM 1/16W 5% 0402 SMD	Panasonic - ECG	ERJ-2GEJ102X
17	2	610-13472	R9,R8	RES CHIP 620 OHM 1/16W 5% 0402 SMD	Panasonic - ECG	ERJ-2GEJ621X
18	2	610-10684	R10, R11	RES CHIP 100 OHM 1/16W 5% 0402 SMD	Phycomp USA Inc	9C1A04021000FLHF3
19	1	200-13471	S1	SWITCH LT 3.5MMX2.9MM 160GF SMD	Panasonic - ECG	EVQ-P7J01K
20	1	CYRF7936-40LFC	U1	IC, 2.4 GHz CyFi Transceiver QFN-40	Cypress Semiconductor	CYRF7936 Rev A5
21	1	CY8C24794-24LFXI	U2	PSoC Mixed Signal Array	Cypress Semiconductor	CY8C24794-24LFXI
22	1	800-13259	Y1	Crystal 12.00 MHZ HC49 SMD	eCERA	GF-1200008
23	1		LABEL1	Serial Number	XXXXXX	

Absolute Maximum Ratings

Exceeding maximum ratings may shorten the useful life of the device. User guidelines are not tested.

- Storage temperature -65 °C to +150 °C
- Ambient temperature with power applied . -55 °C to +125 °C
- Supply voltage on any power supply pin relative to V_{SS} -0.3 V to +3.9 V
- DC voltage to logic inputs^[8] -0.3 V to V_{IO} +0.3 V
- DC voltage applied to outputs in high-Z state -0.3 V to V_{IO} +0.3 V

- Static discharge voltage (digital)^[9] >2000 V
- Static discharge voltage (RF)^[9] 1100 V
- Latch-up current +200 mA, -200 mA

Operating Conditions

- V_{CC} 2.4 V to 3.6 V
- V_{IO} 1.8 V to 3.6 V
- V_{BAT} 1.8 V to 3.6 V
- T_A (ambient temperature under bias) 0 °C to +70 °C
- Ground voltage 0 V
- F_{OSC} (crystal frequency) 12 MHz ±30 ppm b

DC Characteristics

(T = 25 °C, V_{BAT} = 2.4 V, PMU disabled, f_{OSC} = 12.000000 MHz)

Parameter	Description	Conditions	Min	Typ	Max	Unit
V _{BAT}	Battery voltage	0 °C to 70 °C	1.8	-	3.6	V
V _{REG} ^[10]	PMU output voltage	2.4 V mode	2.4	2.43	-	V
V _{REG} ^[10]	PMU output voltage	2.7 V mode	2.7	2.73	-	V
V _{IO} ^[11]	V _{IO} voltage		1.8	-	3.6	V
V _{CC}	V _{CC} voltage	0 °C to 70 °C	2.4 ^[12]	-	3.6	V
V _{OH1}	Output high voltage condition 1	At I _{OH} = -100.0 μA	V _{IO} - 0.2	V _{IO}	-	V
V _{OH2}	Output high voltage condition 2	At I _{OH} = -2.0 mA	V _{IO} - 0.4	V _{IO}	-	V
V _{OL}	Output low voltage	At I _{OL} = 2.0 mA	-	0	0.45	V
V _{IH}	Input high voltage		0.7V _{IO}	-	V _{IO}	V
V _{IL}	Input low voltage		0	-	0.3V _{IO}	V
I _{IL}	Input leakage current	0 < V _{IN} < V _{IO}	-1	0.26	+1	μA
C _{IN}	Pin input capacitance	Except XTAL, RF _N , RF _P , RF _{BIAS}	-	3.5	10	pF
I _{CC} (GFSK) ^[13]	Average TX I _{CC} , 1 Mbps, slow channel	PA = 5, 2 way, 4 bytes/10 ms	-	0.87	-	mA
I _{CC} (32-8DR) ^[13]	Average TX I _{CC} , 250 kbps, fast channel	PA = 5, 2 way, 4 bytes/10 ms	-	1.2	-	mA
I _{SB} ^[14]	Sleep mode I _{CC}		-	0.8	10	μA
I _{SB} ^[14]	Sleep mode I _{CC}	PMU enabled	-	31.4	-	μA
IDLE I _{CC}	Radio off, XTAL Active	XOUT disabled	-	1.0	-	mA
I _{synth}	I _{CC} during synth start		-	8.4	-	mA
TX I _{CC}	I _{CC} during transmit	PA = 5 (-5 dBm)	-	20.8	-	mA
TX I _{CC}	I _{CC} during transmit	PA = 6 (0 dBm)	-	26.2	-	mA
TX I _{CC}	I _{CC} during transmit	PA = 7 (+4 dBm)	-	34.1	-	mA
RX I _{CC}	I _{CC} during receive	LNA off, ATT on	-	18.4	-	mA
RX I _{CC}	I _{CC} during receive	LNA on, ATT off	-	21.2	-	mA
Boost Eff	PMU boost converter efficiency	V _{BAT} = 2.5 V, V _{REG} = 2.73 V, I _{LOAD} = 20 mA	-	81	-	%
I _{LOAD_EXT} ^[15]	Average PMU external load current	V _{BAT} = 1.8 V, V _{REG} = 2.73 V, 0-50 °C, RX mode	-	-	15	mA
I _{LOAD_EXT} ^[15]	Average PMU external load current	V _{BAT} = 1.8V, V _{REG} = 2.73V, 50 °C-70 °C, RX mode	-	-	10	mA

Notes

8. It is permissible to connect voltages above V_{IO} to inputs through a series resistor limiting input current to 1 mA. AC timing not guaranteed.
9. Human body model (HBM).
10. V_{REG} depends on battery input voltage.
11. In sleep mode, the I/O interface voltage reference is V_{BAT}.
12. In sleep mode, V_{CC} min. can be as low as 1.8 V.
13. Includes current drawn while starting crystal, starting synthesizer, transmitting packet (including SOP and CRC16), changing to receive mode, and receiving ACK handshake. Device is in sleep except during this transaction.
14. ISB is not guaranteed if any I/O pin is connected to voltages higher than V_{IO}.
15. I_{LOAD_EXT} is dependant on external components and this entry applies when the components connected to L/D are SS12 series diode and DH53100LC inductor from Sumida.

AC Characteristics

Table 6. SPI Interface^[16, 17]

Parameter	Description	Min	Typ	Max	Unit
t_{SCK_CYC}	SPI clock period	238.1	–	–	ns
t_{SCK_HI}	SPI clock high time	100	–	–	ns
t_{SCK_LO}	SPI clock low time	100	–	–	ns
t_{DAT_SU}	SPI input data setup time	25	–	–	ns
t_{DAT_HLD}	SPI input data hold time	10	–	–	ns
t_{DAT_VAL}	SPI output data valid time	0	–	50	ns
$t_{DAT_VAL_TRI}$	SPI output data tristate (MOSI from slave select deassert)		–	20	ns
t_{SS_SU}	SPI slave select setup time before first positive edge of SCK ^[18]	10	–	–	ns
t_{SS_HLD}	SPI slave select hold time after last negative edge of SCK	10	–	–	ns
t_{SS_PW}	SPI slave select minimum pulse width	20	–	–	ns
t_{SCK_SU}	SPI slave select setup time	10	–	–	ns
t_{SCK_HLD}	SPI SCK hold time	10	–	–	ns
t_{RESET}	Minimum RST pin pulse width	10	–	–	ns

Figure 10. SPI Timing

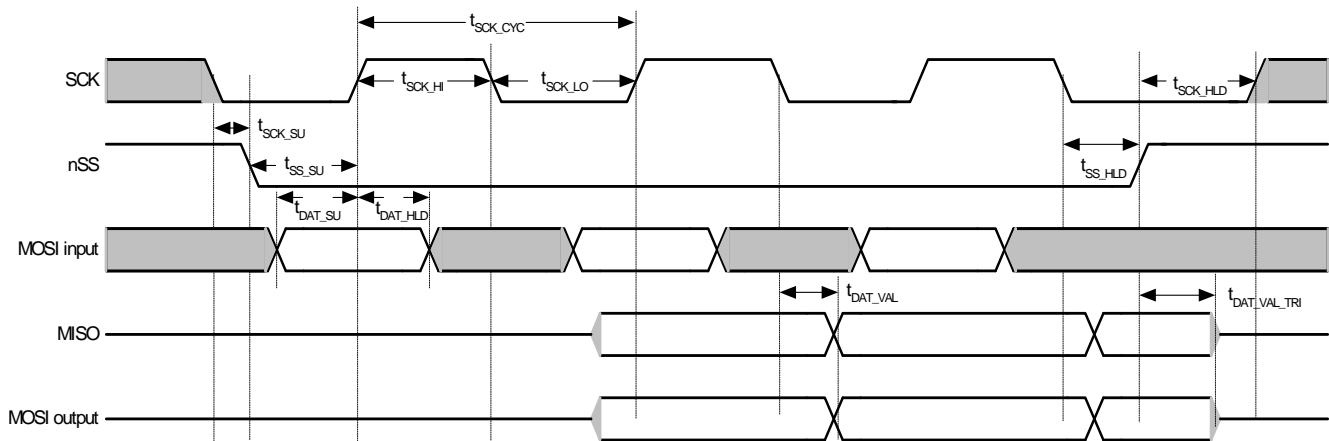

Notes

- 16. AC values are not guaranteed if voltage on any pin exceeding V_{IO} .
- 17. $C_{LOAD} = 30$ pF
- 18. SCK must start low at the time SS# goes LOW, otherwise the success of SPI transactions are not guaranteed.

RF Characteristics
Table 7. Radio Parameters

Parameter Description	Conditions	Min	Typ	Max	Unit
RF frequency range	Refer Note 19	2.400	–	2.497	GHz
Receiver (T = 25 °C, V _{CC} = 3.0 V, f _{OSC} = 12.000000 MHz, BER < 1E-3)					
Sensitivity 125 kbps 64-8DR	BER 1E-3		–97	–	dBm
Sensitivity 250 kbps 32-8DR	BER 1E-3		–93	–	dBm
Sensitivity	CER 1E-3	–80	–87	–	dBm
Sensitivity GFSK	BER 1E-3, ALL SLOW = 1		–84	–	dBm
LNA gain		–	22.8	–	dB
ATT gain		–	–31.7	–	dB
Maximum received signal	LNA On	–15	–6	–	dBm
RSSI value for PWR _{in} –60 dBm ^[20]	LNA On		21	–	Count
RSSI slope			1.9	–	dB/Count
Interference Performance (CER 1E-3)					
Co-channel Interference rejection carrier-to-Interference (C/I)	C = –60 dBm	–	9	–	dB
Adjacent (±1 MHz) channel selectivity C/I 1 MHz	C = –60 dBm	–	3	–	dB
Adjacent (±2 MHz) channel selectivity C/I 2 MHz	C = –60 dBm	–	–30	–	dB
Adjacent (≥ 3 MHz) channel selectivity C/I ≥ 3 MHz	C = –67 dBm	–	–38	–	dB
Out-of-band blocking 30 MHz–12.75 MHz ^[21]	C = –67 dBm	–	–30	–	dBm
Intermodulation	C = –64 dBm, Δf = 5, 10 MHz	–	–36	–	dBm
Receive Spurious Emission					
800 MHz	100 kHz ResBW	–	–79	–	dBm
1.6 GHz	100 kHz ResBW	–	–71	–	dBm
3.2 GHz	100 kHz ResBW	–	–65	–	dBm
Transmitter (T = 25°C, V _{CC} = 3.0 V)					
Maximum RF transmit power	PA = 7	+2	4	+6	dBm
Maximum RF transmit power	PA = 6	–2	0	+2	dBm
Maximum RF transmit power	PA = 5	–7	–5	–3	dBm
Maximum RF transmit power	PA = 0	–	–35	–	dBm
RF power control range		–	39	–	dB
RF power range control step size	Seven steps, monotonic	–	5.6	–	dB
Frequency deviation min	PN code pattern 10101010	–	270	–	kHz
Frequency deviation max	PN code pattern 11110000	–	323	–	kHz
Error vector magnitude (FSK error)	>0 dBm	–	10	–	%rms
Occupied bandwidth	–6 dBc, 100 kHz ResBW	500	876	–	kHz
Transmit Spurious Emission (PA = 7)					
In-band spurious second channel power (±2 MHz)		–	–38	–	dBm
In-band spurious third channel power (≥3 MHz)		–	–44	–	dBm

Notes

19. Subject to regulation.
 20. RSSI value is not guaranteed. Extensive variation from part to part.
 21. Exceptions F/3 and 5C/3.

Table 7. Radio Parameters (continued)

Parameter Description	Conditions	Min	Typ	Max	Unit
Non harmonically related spurs (800 MHz)		–	–38	–	dBm
Non harmonically related spurs (1.6 GHz)		–	–34	–	dBm
Non harmonically related spurs (3.2 GHz)		–	–47	–	dBm
Harmonic spurs (second harmonic)		–	–43	–	dBm
Harmonic spurs (third harmonic)		–	–48	–	dBm
Fourth and greater harmonics		–	–59	–	dBm
Power Management (Crystal PN# eCERA GF-1200008)					
Crystal start to 10 ppm		–	0.7	1.3	ms
Crystal start to IRQ	XSIRQ EN = 1	–	0.6	–	ms
Synth settle	Slow channels	–	–	270	μs
Synth settle	Medium channels	–	–	180	μs
Synth settle	Fast channels	–	–	100	μs
Link turnaround time	GFSK	–	–	30	μs
Link turnaround time	250 kbps	–	–	62	μs
Link turnaround time	125 kbps	–	–	94	μs
Link turnaround time	<125 kbps	–	–	31	μs
Maximum packet length	<60 ppm crystal-to-crystal	–	–	40	bytes

Typical Operating Characteristics

The typical operating characteristics of CYRF7936 follow^[22]

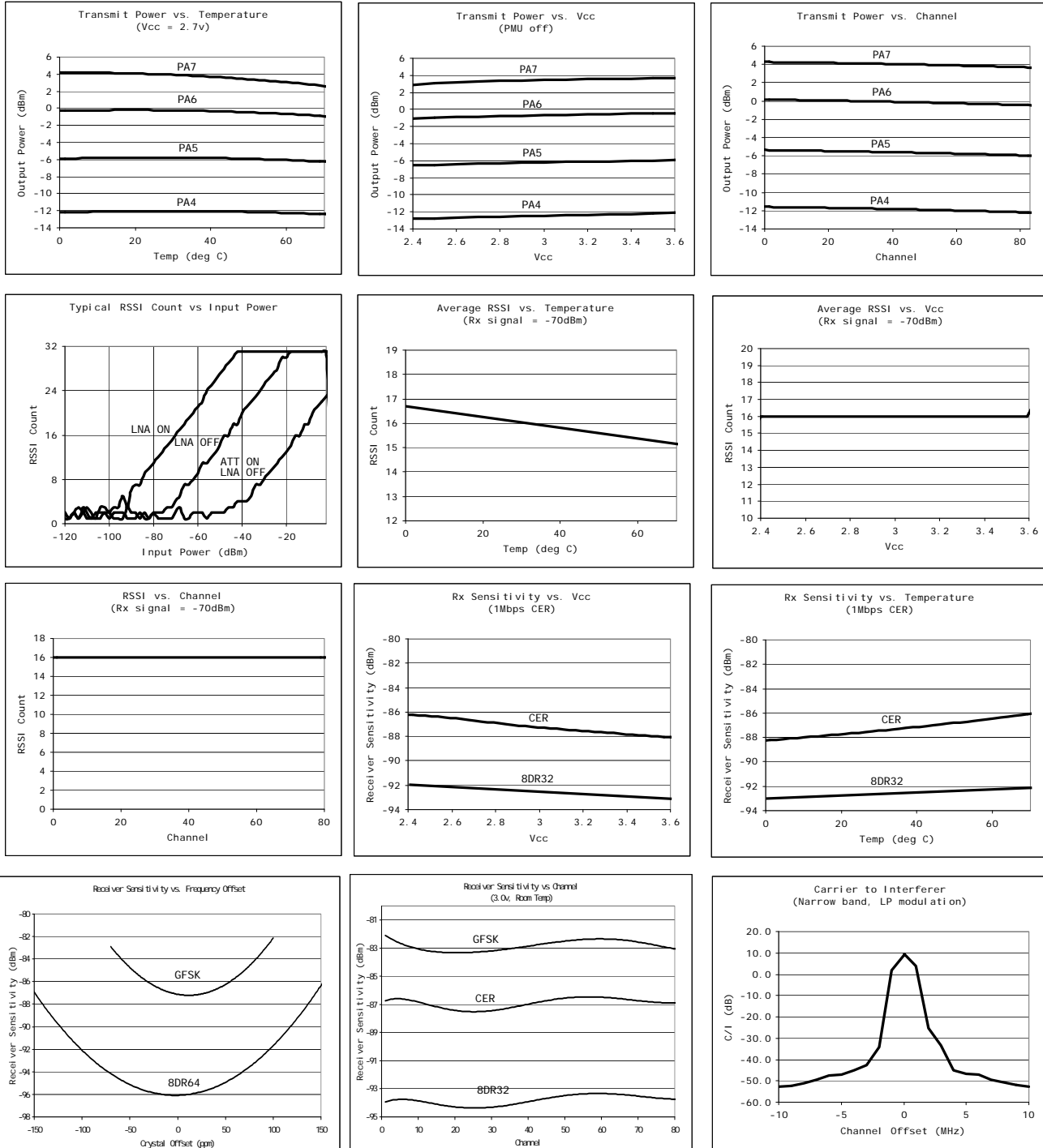

Note

22. With LNA on, ATT off, above -2dBm erroneous RSSI values may be read. Cross-checking RSSI with LNA off/on is recommended for accurate readings.

Typical Operating Characteristics (continued)

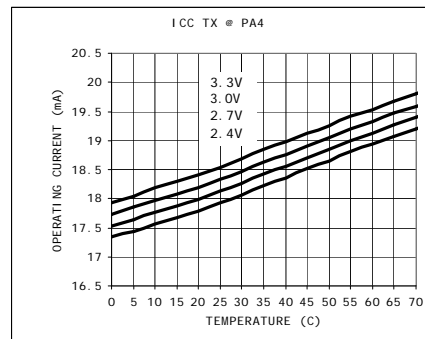
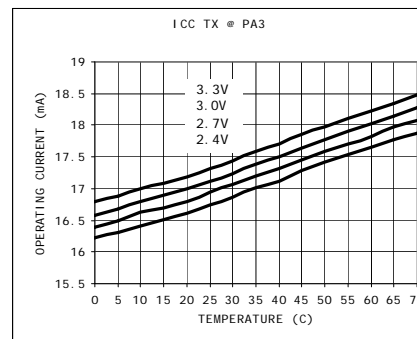
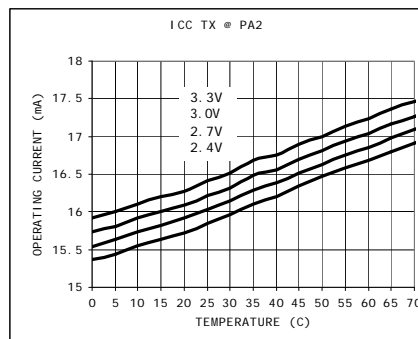
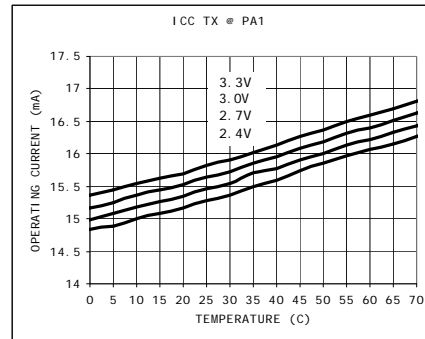
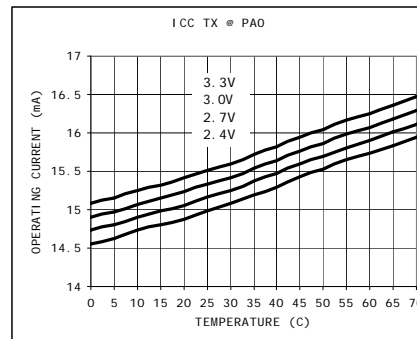
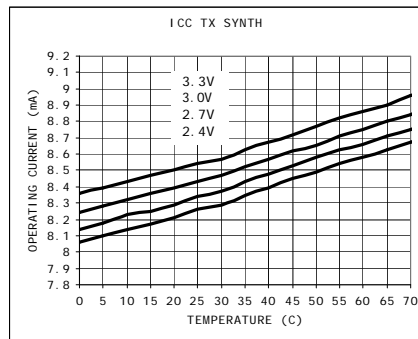
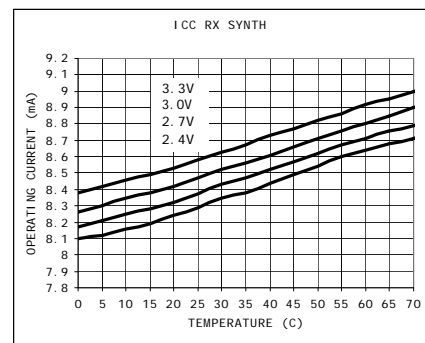
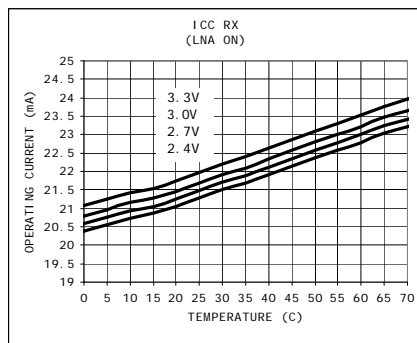
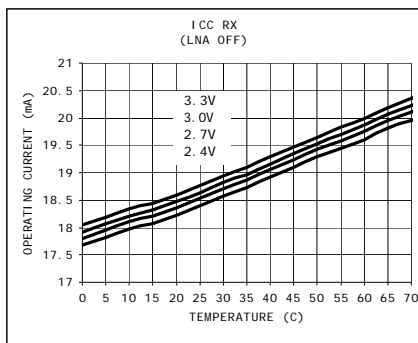
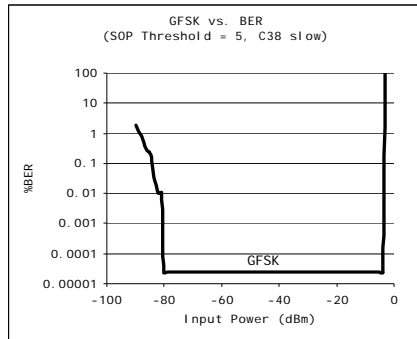
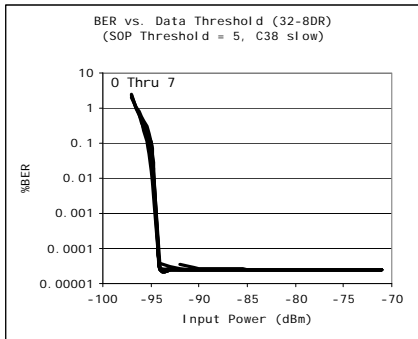

Typical Operating Characteristics (continued)

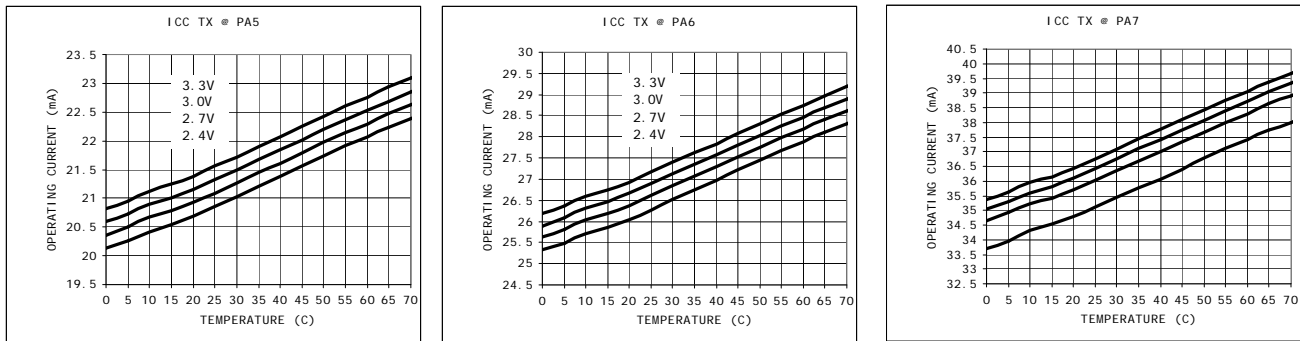
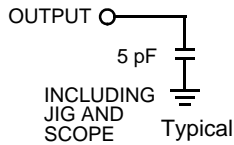
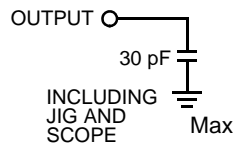
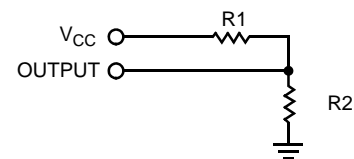

Figure 11. AC Test Loads and Waveforms for Digital Pins

AC Test Loads



DC Test Load



Parameter		Unit
R1	1071	Ω
R2	937	Ω
R _{TH}	500	Ω
V _{TH}	1.4	V
V _{CC}	3.00	V

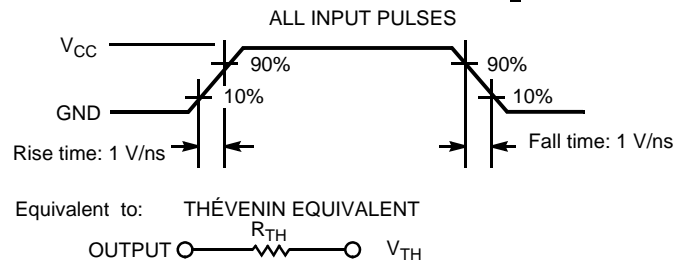

Ordering Information

Part Number	Radio	Package Name	Package Type	Operating Range
CYRF7936-40LTXC	Transceiver	40-QFN	40-QFN (Sawn type)	Commercial

Ordering Code Definitions

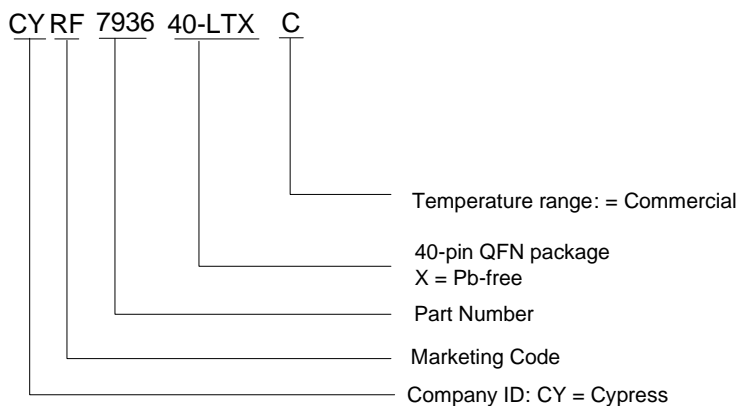

Package Description

The recommended dimension of the PCB pad size for the E-pad underneath the QFN is 3.5 mm x 3.5 mm (width x length).

Figure 12. 40-Pin Sawn QFN (6 x 6 x 0.90 mm)

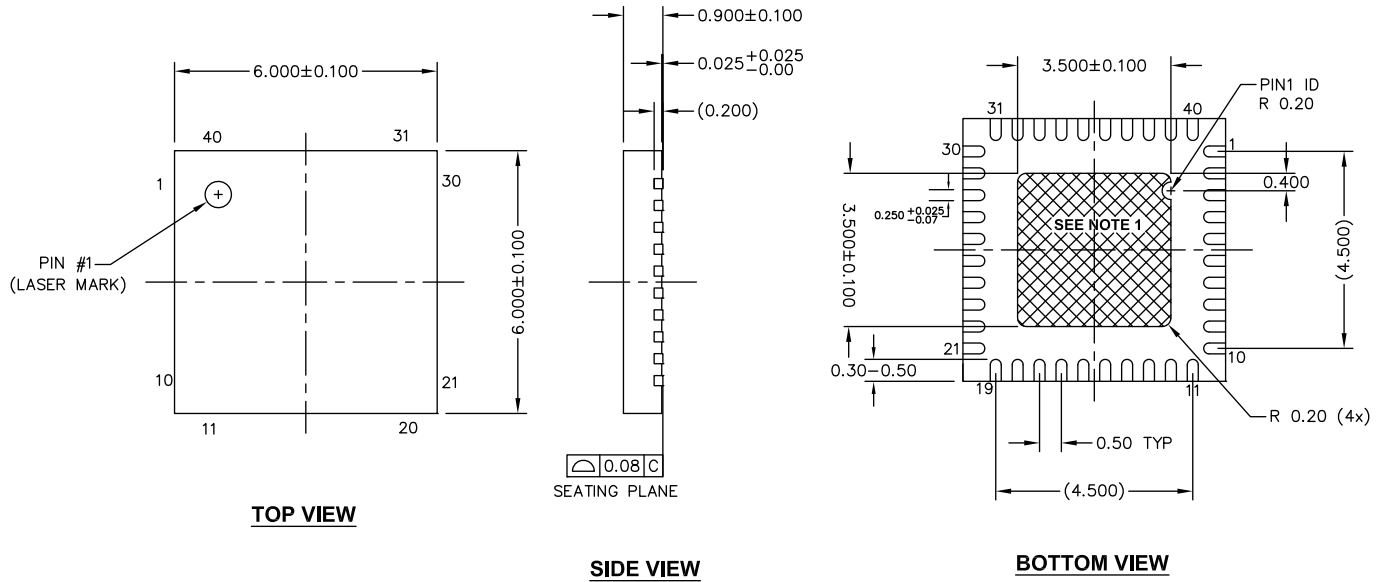

NOTES:

1.  HATCH IS SOLDERABLE EXPOSED AREA.
2. REFERENCE JEDEC #: MO-220
3. PACKAGE WEIGHT: 0.086g
4. ALL DIMENSIONS ARE IN MILLIMETERS

001-44328 *F

Acronyms

Table 8. Acronyms Used in this Document

Acronym	Description
ACK	acknowledge (packet received, no errors)
ATS	auto transaction sequencer
BER	bit error rate
BOM	bill of materials
CMOS	complementary metal oxide semiconductor
CRC	cyclic redundancy check
DSSS	direct sequence spread spectrum
EOP	end-of-packet
FEC	forward error correction
GFSK	gaussian frequency-shift keying
HBM	human body model
ISM	industrial, scientific, and medical
IRQ	interrupt request
LNA	low-noise amplifier
MCU	microcontroller unit
MISO	master in slave out
MOSI	master out slave in
PA	power amplifier
PLL	phase locked loop
PMU	power management unit
PN	pseudo noise
QFN	quad flat no-leads
RSSI	received signal strength indication
RF	radio frequency
Rx	receive
SCK	serial clock
SDAT	serial data
SOP	start-of-packet
SPI	serial peripheral interface
Tx	transmit

Document Conventions

Units of Measure

Table 9. Units of Measure

Symbol	Unit of Measure
°C	degree Celsius
dB	decibels
dBc	decibel relative to carrier
dBm	decibel-milliwatt
Hz	hertz
KB	kilobyte, 1024 bytes
Kbit	kilobit, 1024 bits
kHz	kilohertz
kΩ	kilohms
MHz	megahertz
MΩ	megaohm
μA	microamperes
μs	microseconds
μV	microvolts
μVrms	microvolts root-mean-square
μW	microwatts
mA	milliampere
ms	millisecond
mV	millivolts
nA	nanoampere
ns	nanosecond
nV	nanovolts
Ω	ohm
pp	peak-to-peak
ppm	parts per million
ps	picosecond
sps	samples per second
V	volts

Document History Page

Description Title: CYRF7936, 2.4-GHz CyFi™ Transceiver Document Number: 001-48013				
Revision	ECN	Orig. of Change	Submission Date	Description of Change
**	2557501	KKU / AESA	08/25/2008	New data sheet
*A	2615458	KKU / AESA	01/13/2009	Updated block diagram, changed SoP to SOP, changed EoP to EOP, changed Frequency Initial Stability to Frequency Stability, change section on Low Noise Amplifier. to Receiver Front End and removed AGC enable. Updated Register Map Summary.
*B	2672793	DPT / PYRS	03/12/2009	Updated packaging and ordering information.
*C	2902376	TGE	03/31/2010	Removed inactive parts from Ordering Information. Updated Package Diagram.
*D	2927979	TGE / AESA	05/05/2010	Removed Register Descriptions section. Added Contents Updated links in Sales, Solutions, and Legal Information .
*E	3028381	TGE	09/13/2010	Updated Applications Support section Added Ordering Code Definitions . Added Acronyms and Units of Measure .
*F	3346285	TGE	08/18/2011	Updated to latest template Added footnote 20 on page 16. Added " Receive Spurious Response " on page 9.
*G	3611344	TGE	05/08/2012	Updated package diagram spec to *F revision.
*H	4525927	ANKC	10/06/2014	Updated in new template. Completing Sunset Review.

Sales, Solutions, and Legal Information

Worldwide Sales and Design Support

Cypress maintains a worldwide network of offices, solution centers, manufacturer's representatives, and distributors. To find the office closest to you, visit us at [Cypress Locations](#).

Products

Automotive	cypress.com/go/automotive
Clocks & Buffers	cypress.com/go/clocks
Interface	cypress.com/go/interface
Lighting & Power Control	cypress.com/go/powerpsoc cypress.com/go/plc
Memory	cypress.com/go/memory
PSoC	cypress.com/go/psoc
Touch Sensing	cypress.com/go/touch
USB Controllers	cypress.com/go/USB
Wireless/RF	cypress.com/go/wireless

PSoC[®] Solutions

[psoc.cypress.com/solutions](#)
[PSoC 1](#) | [PSoC 3](#) | [PSoC 4](#) | [PSoC 5LP](#)

Cypress Developer Community

[Community](#) | [Forums](#) | [Blogs](#) | [Video](#) | [Training](#)

Technical Support

[cypress.com/go/support](#)

© Cypress Semiconductor Corporation, 2007-2014. The information contained herein is subject to change without notice. Cypress Semiconductor Corporation assumes no responsibility for the use of any circuitry other than circuitry embodied in a Cypress product. Nor does it convey or imply any license under patent or other rights. Cypress products are not warranted nor intended to be used for medical, life support, life saving, critical control or safety applications, unless pursuant to an express written agreement with Cypress. Furthermore, Cypress does not authorize its products for use as critical components in life-support systems where a malfunction or failure may reasonably be expected to result in significant injury to the user. The inclusion of Cypress products in life-support systems application implies that the manufacturer assumes all risk of such use and in doing so indemnifies Cypress against all charges.

Any Source Code (software and/or firmware) is owned by Cypress Semiconductor Corporation (Cypress) and is protected by and subject to worldwide patent protection (United States and foreign), United States copyright laws and international treaty provisions. Cypress hereby grants to licensee a personal, non-exclusive, non-transferable license to copy, use, modify, create derivative works of, and compile the Cypress Source Code and derivative works for the sole purpose of creating custom software and or firmware in support of licensee product to be used only in conjunction with a Cypress integrated circuit as specified in the applicable agreement. Any reproduction, modification, translation, compilation, or representation of this Source Code except as specified above is prohibited without the express written permission of Cypress.

Disclaimer: CYPRESS MAKES NO WARRANTY OF ANY KIND, EXPRESS OR IMPLIED, WITH REGARD TO THIS MATERIAL, INCLUDING, BUT NOT LIMITED TO, THE IMPLIED WARRANTIES OF MERCHANTABILITY AND FITNESS FOR A PARTICULAR PURPOSE. Cypress reserves the right to make changes without further notice to the materials described herein. Cypress does not assume any liability arising out of the application or use of any product or circuit described herein. Cypress does not authorize its products for use as critical components in life-support systems where a malfunction or failure may reasonably be expected to result in significant injury to the user. The inclusion of Cypress' product in a life-support systems application implies that the manufacturer assumes all risk of such use and in doing so indemnifies Cypress against all charges.

Use may be limited by and subject to the applicable Cypress software license agreement.