

**FAILURE TO READ AND FOLLOW ALL INSTRUCTIONS CAREFULLY BEFORE
INSTALLING OR OPERATING THIS CONTROL COULD CAUSE PERSONAL
INJURY AND/OR PROPERTY DAMAGE.**

DESCRIPTION

The 50M56U-751 kit is a Single Stage HSI Integrated Furnace Control kit for Carrier. This kit replaces the following Carrier controls:

Carrier			White-Rodgers
HK42FZ004	HK42FZ009	HK42FZ016	50M56-751
HK42FZ007	HK42FZ011	HK42FZ034	
HK42FZ008	HK42FZ013	325878-751*	

*Universal replacement for all Carrier controls.

The control employs a microprocessor to continually monitor, analyze, and control the proper operation of the gas burner, inducer, and fan.

Twining: The control board in this Kit CANNOT be twinned with any of the Carrier circuit boards.

The kit contains:

- 1 – 50M56-751 ignition control board
- 1 – Set of interconnect harnesses
- 1 – Manual
- 1 – Bag of accessories

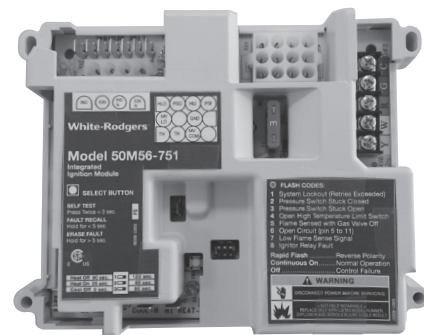

50M56-751

PRECAUTIONS

Installation should be done by a qualified heating and air conditioning contractor or licensed electrician.

If in doubt about whether your wiring is millivolt, line, or low voltage, have it inspected by a qualified heating and air conditioning contractor or licensed electrician.

Do not exceed the specification ratings.

All wiring must conform to local and national electrical codes and ordinances.

This control is a precision instrument, and should be handled carefully. Rough handling or distorting components could cause the control to malfunction.

Following installation or replacement, follow manufacturer's recommended installation/service instructions to ensure proper operation.

CAUTION

Do not short out terminals on gas valve or primary control. Short or incorrect wiring may damage the thermostat.

WARNING



Failure to comply with the following warnings could result in personal injury or property damage.

FIRE HAZARD

- Do not exceed the specified voltage.
- Replace existing control with exact model and dash number.
- Protect the control from direct contact with water (dripping, spraying, rain, etc.).
- If the control has been in direct contact with water, replace the control.
- Label all wires before disconnection when servicing controls. Wiring errors can cause improper and dangerous operation.
- Route and secure wiring away from flame.

SHOCK HAZARD

- Disconnect electric power before servicing.
- Ensure proper earth grounding of appliance.
- Ensure proper connection of line neutral and line hot wires.

EXPLOSION HAZARD

- Shut off main gas to appliance until installation is complete.

SPECIFICATIONS

ELECTRICAL RATINGS [@ 77°F (25°C)]:

Input Voltage: 25 VAC 50/60 Hz

Max. Input Current @ 25 VAC: 0.45 amp

Relay Load Ratings:

Valve Relay: 1.5 amp @ 25 VAC 50/60 Hz 0.6 pf

Ignitor Relay: 6.0 amp @ 120 VAC 50/60 Hz (resistive)

Inducer Relay: 2.2 FLA–3.5 LRA @ 120 VAC

Circulator Relay: 14.5 FLA–25.0 LRA @ 120 VAC

Flame Current Requirements:

Minimum current to insure flame detection: 1 µA DC*

Maximum current for non-detection: 0.1 µA DC*

Maximum allowable leakage resistance: 100 M ohms

*Measured with a DC microammeter in the flame probe lead

OPERATING TEMPERATURE RANGE:

-40° to 176°F (-40° to 80°C)

HUMIDITY RANGE:

MOUNTING:

Surface mount multipoise

Timing Specs: (@ 60 Hz)

Flame Establishing Time:	maximum 0.8 sec
Flame Failure Response Time:	2.0 sec

Gases Approved: Natural, Manufactured, Mixed, Liquefied Petroleum, and LP Gas Air Mixtures are all approved for use.

TIMING SPECIFICATIONS

(All times are in seconds, unless noted otherwise)

	50M56-751
Pre-Purge	30
Initial Ignitor Warm-Up (1st 64 attempts)	17
Maximum Ignitor Warm-Up	19
Ignition Activation Period	2
Trial for Ignition Period	4
Retries	2
Recycles	3
Valve Sequence Period	12
Interpurge	60
Post-Purge	25
Lockout Time	275
Heat Delay-To-Fan-On	25/60*
Heat Delay-To-Fan-Off	90/120*
Cool Delay-To-Fan-On	2
Cool Delay-To-Fan-Off	5/90*
Auto Reset	60 minutes

*These times will vary depending on option switch position. See OPERATION section for further information.

INSTALLATION



WARNING





FIRE HAZARD

- Do not exceed the specified voltage.
- Replace existing control with exact model and dash number.
- Protect the control from direct contact with water (dripping, spraying, rain, etc.).
- If the control has been in direct contact with water, replace the control.
- Label all wires before disconnection when servicing controls. Wiring errors can cause improper and dangerous operation.
- Route and secure wiring away from flame.

SHOCK HAZARD

- Disconnect electric power before servicing.
- Ensure proper earth grounding of appliance.
- Ensure proper connection of line neutral and line hot wires.

EXPLOSION HAZARD

- Shut off main gas to appliance until installation is complete.



CAUTION

Do not short out terminals on gas valve or primary control. Short or incorrect wiring may damage the thermostat.

MOUNTING AND WIRING

All wiring should be installed by a qualified heating and air conditioning contractor or licensed electrician, according to local and national electrical codes and ordinances.

The control must be secured to an area that will experience a minimum of vibration and remain below the maximum ambient temperature rating of 176°F. The control is approved for minimum ambient temperatures of -40°F.

When mounting the control, any orientation is acceptable. Choose a location that will not damage, obstruct or place stress on the control's terminations, system wiring harness or system components. After finding a suitable location, drill four (4) 1/8" holes for mounting control. To ensure proper mounting hole locations, use the control as a template. When drilling the holes, take care so that the transformer, wiring harness or other system components are not damaged. Four (4) #8 sheet metal screws are provided to complete the installation.

Refer to the wiring diagram and wiring table when connecting the 50M56U-751 control to other components of the system.

UL approved, 105°C rated 18 gauge, stranded, 2/64" thick insulation wire is recommended for all low voltage safety circuit connections.

UL approved 105°C rated 16 gauge min., stranded, 4/64" thick insulation wire is recommended for all line voltage connections.

After installation or replacement, follow appliance manufacturer's recommended installation or service instructions to ensure proper operation.

INSTALLER MUST READ FOR PROPER INSTALLATION

- Before removing existing control board, tag wires to assure proper connection to new board.
- Wiring harness adaptors are included in this kit. Wiring harness adaptors will be used when replacing existing control as indicated below. The remaining harnesses can be discarded.
- **IMPORTANT:** For low speed continuous fan speed operation, one of the unused parked motor taps must be connected to the low heat speed terminal. Failure to do this will result in the blower not energizing in the constant fan mode operation. Refer to figure 1.

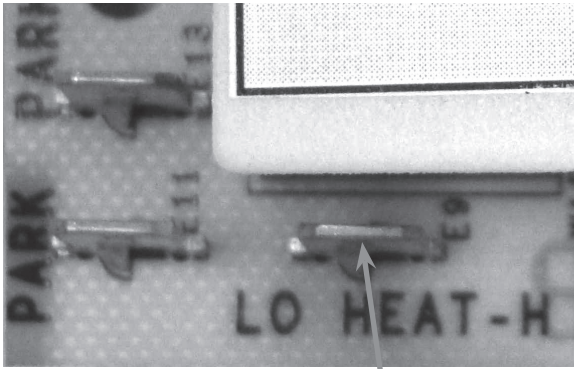

Figure 1 For low speed continuous fan speed connect one of the unused parked terminals here

TABLE 1

Type	Existing Control	New Control
24V Thermostat Terminals	G	G
	R	R
	Y	Y
	W	W
	Com 24V	C
Humidification (24V) Thermostat or 1/4" Spade	HUM	See Harness Adaptor
Humidification (120V)	N/A	HUM-H
Transformer 24 VAC (+)	SEC-1	TH (In 12-pin connector)
Transformer 24 VAC (-)	SEC-2	TR (In 12-pin connector)
Twin	Test/Twin	N/A
Self Test	Test/Twin to Com 24V	Selection Button (Fault)
Blower Speed Selection (120V)	Cool	Cool-H
	Heat	HI-Heat
	Spare-1	Park
	Spare-2	Park
Low Speed Continuous Fan (120V)	N/A	LO-Heat
Blower Neutral	COM/BLW	Line Neutral (use L adapter wire)
Power (120V)	L1	LINE-H
Power Neutral	L2/Neutral	Line Neutral
Transformer (120V)	PR-1	XFMR-H
Transformer Neutral	PR2/Neutral	Line Neutral
Electronic Air Cleaner (120V)	EAC-1	EAC-H
Electronic Air Cleaner Neutral	EAC-2	Line Neutral
Flame Sensor Probe	from 9-Pin Connector	FS

Replacing HK42FZ004, HK42FZ007, HK42FZ008, HK42FZ009, HK42FZ011, and HK42FZ016

Use Old Style Wiring Harness Adaptor. Reference Fig. 2, Table 1 and Wiring Diagram.

1. With power removed, connect the old style wiring adapter (Reference Fig. 2) 9-pin connector, Inducer connector, and Ignitor connector to the appropriate connectors in the furnace.
2. Connect the 24 VAC and 24 VAC common wires per Table 1.
3. Connect the 12-pin, 4-pin and Flame Sense (FS) connectors to the new control
4. Connect the remaining wires to the replacement control per Table 1.

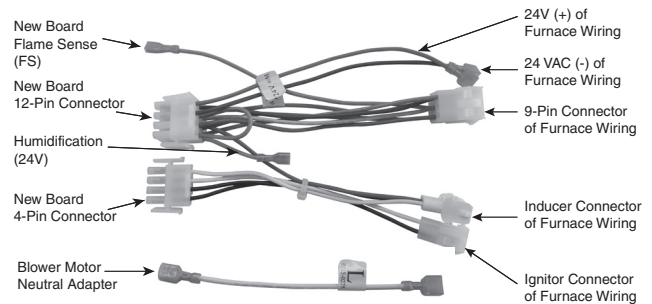

Figure 2 – Old Style Wiring Harness Adaptor

Replacing HK42FZ013, HK42FZ034

Use New Style Wiring Harness Adaptor. Reference Fig 3, Table 1 and Wiring Diagram.

1. With power removed, connect the New style wiring adapter (Reference Fig. 3) 11-pin In-line connector, Inducer connector and Ignitor connector to the appropriate connectors in the furnace.
2. Connect the 24 VAC and 24 VAC common wires per Table 1.
3. Connect the 12-pin, 4-pin and Flame Sense (FS) connectors to the new control.
4. Connect the remaining wires to the replacement control per Table 1.

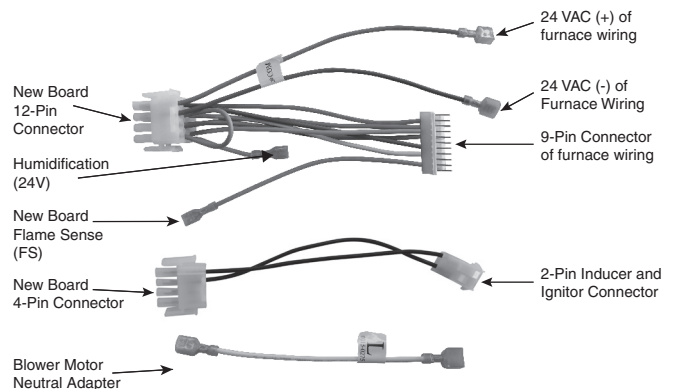
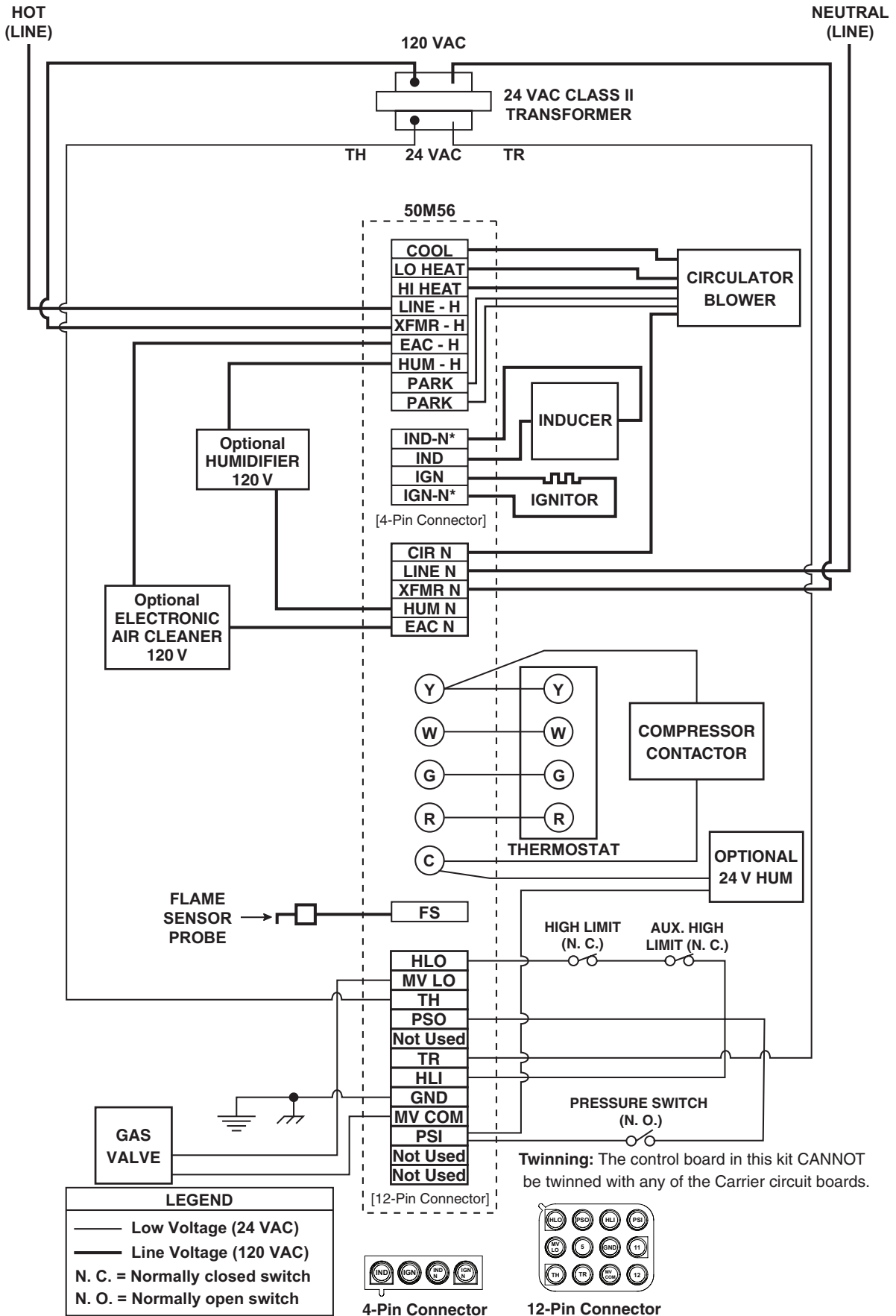

Figure 3 – New Style Wiring Harness Adaptor



WIRING DIAGRAM

TYPICAL SYSTEM WIRING DIAGRAM

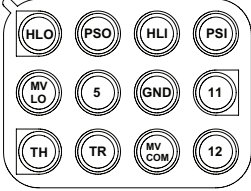

*Use Line Neutral terminal when replacing new style control.

TYPICAL SYSTEM WIRING TABLE

50M56 TERMINAL	TERMINAL TYPE	SYSTEM COMPONENT CONNECTION
W G R Y C	Terminal block with captive screws	low voltage thermostat W terminal (or equivalent) low voltage thermostat G terminal (or equivalent) low voltage thermostat R terminal (or equivalent) low voltage thermostat Y terminal (or equivalent) (2nd wire from Y terminal goes to 24 VAC HOT side of compressor contactor coil) 24 VAC COMMON side of compressor contactor coil
HLO (Pin 1) MV LO (Pin 2) TH (Pin 3) PSO (Pin 4) Not used (Pin 5) TR (Pin 6) HLI (Pin 7) GND (Pin 8) MV COM (Pin 9) PSI (Pin 10) Not used (Pin 11) Not used (Pin 12)		high limit and flame rollout OUTPUT gas valve first stage 24 VAC transformer (low voltage HIGH side) pressure switch and low gas pressure switch OUTPUT Not used 24 VAC transformer (low voltage COMMON side) high limit and flame rollout INPUT MUST BE RELIABLY GROUNDED TO CHASSIS gas valve COMMON pressure switch / low gas pressure switch INPUT and optional 24V HUM Not used Not used
IND (Pin 1) IGN (Pin 2) IND-N (Pin 3) IGN-N (Pin 4)		inducer HOT side ignitor HOT side inducer NEUTRAL side (or 1/4" Line Neutral) ignitor NEUTRAL side (or 1/4" Line Neutral)
COOL	spade terminal	circulator blower COOL SPEED terminal
LO HEAT	spade terminal	circulator blower continuous FAN terminal
HI HEAT	spade terminal	circulator blower HI HEAT SPEED terminal
PARK (2 terminals)	spade terminal	unused terminals
LINE	spade terminal	input voltage (120 VAC) HOT side
XFMR	spade terminal	24 VAC transformer line voltage HOT side
EAC (optional)	spade terminal	electronic air cleaner HOT side
HUM (optional)	spade terminal	humidifier HOT side (120 V)
CIR N	spade terminal	circulator blower NEUTRAL terminal
LINE N	spade terminal	input voltage (120 VAC) NEUTRAL side
XFMR N	spade terminal	24 VAC transformer line voltage NEUTRAL side
EAC N (optional)	spade terminal	electronic air cleaner NEUTRAL side
HUM N (optional)	spade terminal	humidifier NEUTRAL side
FS	spade terminal	flame sensor probe†

† Maximum recommended flame probe wire length is 36 inches.

Twining: The control board in this kit CANNOT be twinned with any of the Carrier circuit boards.

OPERATION

CHECK-OUT AND SELF TEST

The 50M56U-751 is equipped with a self test routine used during the control's installation. The self test checks the functionality of the control, Inducer, Ignitor, and blower to verify they are in proper working order. To initiate self test sequence, ensure thermostat is turned OFF or thermostat wires are disconnected.

To enter self test:

- Turn on power and manually close blower door switch.
- Wait for 5 seconds.
- Slowly double click select button within 3 seconds.

Sequence is as follows:

- LED will flash 4 times then turn ON inducer motor.
- Ignitor will turn ON for several seconds, then OFF.
- Blower motor – HEAT speed will turn ON a few seconds.
- Blower motor – COOL speed will then turn on for several seconds.
- Blower and Inducer will turn off followed by a solid LED.

NOTE

The self test functionality is available after power up and until a Solid LED is present. During this time, the control will ignore all active calls. If a Solid LED is present, disconnect power for 10 seconds and refer above to enter self test routine.

- Repair, replace or service any component that does not work properly during the self test. The gas valve is not energized during self test.
- Turn power off.
- Release blower door switch.
- Connect thermostat wires.
- Make appropriate option switch selections
- Install access doors.
- Turn power back on.
- Turn on gas supply to furnace.
- Run unit through one complete call for heat cycle.

OPTION SWITCHES

The option switches on the 50M56U-751 control are used to determine the length of the heat delay-to-fan-off, heat delay-to-fan-on and cool delay-to-fan-off periods. The following illustration shows the options and the selections of the switch positions. The switches are shown in the factory default positions.

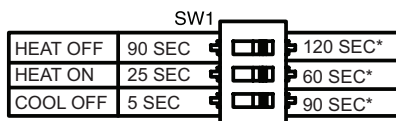

*Default for most controls

HEAT MODE

When heat is required, the thermostat will send a call for heat to the control. This starts the control's heating sequence. The ignitor and humidifier (optional) are powered. The ignitor is powered after the pre-purge period.

Upon initial application of power, the ignitor warm-up time is 17 seconds. The ignitor on-time will then be increased depending on whether or not flame is achieved. The warm-up time is limited to a maximum of 19 seconds. During the first 64 warm-up periods following power-up, the warm-up time may not be less than 17 seconds.

In the event of a retry, the warm-up time will be increased by one second and locked in at that duration. Once the warm-up time is locked, it remains fixed until another call for heat results in a retry, in which case the warm-up time is again increased by one second and remains locked.

In the event of two successive retry attempts, the warm-up time will be unlocked and set to 19 seconds. If flame is then achieved, the warm-up time will begin adapting again with the next call for heat. If, however, this third attempt fails to achieve flame, the control will go into system lockout.

After the ignitor warm-up period, MV LO is energized for the gas valve. Flame must be detected within 4 seconds. If flame is detected, the 30-second HEAT delay-to-fan-on period begins. The circulator and electronic air cleaner (optional) will also energize at this time.

When the thermostat is satisfied, the gas valve is de-energized. After proof of flame loss, the heat delay-to-fan-off period begins and the inducer blower remains energized to purge the system for 25 seconds. When the purge is complete, the inducer blower is de-energized. After the delay-to-fan-off period ends, the circulator fan and electronic air cleaner are de-energized.

If flame is not detected, the valve is de-energized, the ignitor is turned off, and the 50M56U-751 control goes into the "retry" sequence. The "retry" sequence provides a 60-second wait following an unsuccessful ignition attempt (flame not detected). After this wait, the ignition sequence is restarted with an additional 1 second of ignitor warm-up time.

If flame is established for more than 10 seconds after ignition, the 50M56U-751 controller will clear the ignition attempt (or retry) counter. If flame is lost after 10 seconds, it will re-cycle the ignition sequence.

During burner operation, a momentary loss of power of 50 milliseconds or longer will de-energize the main gas valve. When power is restored, the gas valve will remain de-energized and a restart of the ignition sequence will begin immediately.

A momentary loss of gas supply, flame blowout, or a shorted or open condition in the flame probe circuit will be sensed within 2.0 seconds. The gas valve will de-energize and the control will restart the ignition sequence. Recycles will begin and the burner will operate normally if the gas supply returns, or the fault condition is corrected.

If the control has gone into system lockout, it may be possible to reset the control by a momentary power interruption of one second or longer. Refer to **SYSTEM LOCKOUT FEATURES**.

COOL MODE

In a typical system, a call for cool is initiated by closing the thermostat contacts. This energizes the 50M56U-751 control and the compressor. The cool delay-to-fan-on period begins. After the delay period ends, the optional electronic air cleaner is energized, and the circulator fan is energized at cool speed. After the thermostat is satisfied, the compressor is de-energized and the cool mode delay-to-fan-off period begins. After the delay-to-fan-off period ends, the circulator fan and electronic air cleaner (optional) are de-energized.

MANUAL FAN ON MODE

If the thermostat fan switch is moved to the ON position, the circulator fan (low heat speed) and optional electronic air cleaner are energized. When the fan switch is returned to the AUTO position, the circulator fan and electronic air cleaner (optional) are de-energized.

SYSTEM LOCKOUT AND DIAGNOSTIC FEATURES

SYSTEM LOCKOUT FEATURES

When system lockout occurs, the gas valve is de-energized, the circulator blower is energized at heat speed, and, if flame is sensed, the inducer blower is energized. The diagnostic indicator light will flash or glow continuously to indicate system status. **(System lockout will never override the precautionary features.)**

To reset the control after system lockout, do one of the following:

1. Interrupt the call for heat or cool at the thermostat for at least one second but less than 20 seconds (if flame is sensed with the gas valve de-energized, interrupting the call for heat at the thermostat will not reset the control).
2. Interrupt the 24 VAC power at the control for at least one second. You may also need to reset the flame rollout sensor switch.
3. After one hour in lockout, the control will automatically reset itself.

DIAGNOSTIC FEATURES

The 50M56U-751 control continuously monitors its own operation and the operation of the system. If a failure occurs, the LED will indicate a failure code as shown in Troubleshooting section. The control will store the last five fault codes. **If the failure is internal to the control, the LED will stay off or flash 8 times. In this case, the entire control should be replaced, as the control is not field-repairable.**

Failure codes will flash the LED in the following flash-pause sequences to indicate failure status (each flash will last approximately 0.25 seconds, and each pause will last approximately 2 seconds).

DEFINITION OF TERMS

Auto Restart – After one (1) hour of internal or external lockout, the control will automatically reset itself and go into an auto restart purge for 60 seconds.

Cool Delay-To-Fan-Off – The period of time between the loss of a call for cool and the deactivation of the blower motor at Cool speed.

Cool Delay-To-Fan-On – The period of time after a thermostat demand for cool before energizing the circulator blower motor at Cool speed.

Flame Failure Response Time (FFRT) – The period of time between loss of the supervised main burner flame and the action to shut off the gas supply.

Heat Delay-To-Fan-Off – The period of time between the loss of a call for heat and the deactivation of the blower motor at Heat speed.

Heat Delay-To-Fan-On – The period of time between proof of the supervised main burner flame and the activation of the blower motor at Heat speed.

Igniter Warm-up Time – The length of time allowed for the igniter to heat up prior to the initiation of gas flow.

Ignition Activation Period (IAP) – The period of time between energizing the main gas valve and deactivation of the ignition means prior to the end of TFI.

FAULT RECALL

The last five fault codes stored can be displayed on the diagnostic LED. When the control is in standby mode (no call for heat or cool), press the SELECT BUTTON for approximately two seconds or until the diagnostic LED turns off. Release the button and the LED will remain off for two seconds. Then the fault codes will display beginning with the most recent fault first with a two second pause between codes. After the stored fault codes have all displayed, the LED will remain off for two seconds and then turn on to indicate return to normal status. While displaying the stored fault codes, the control will ignore any new call for heat, cool or fan.

FAULT CODE RESET

The stored fault codes can be erased from memory. When the control is in standby mode (no call for heat or cool), press the SELECT BUTTON for five to ten seconds or until the diagnostic LED begins to rapid flash. When the button is released, the LED will turn off for two seconds to indicate the codes are erased. After two seconds the LED will turn on to indicate return to normal status. If the switch is held pressed for over ten seconds the rapid flash will stop and the LED will be on to indicate return to normal status.

The 50M56U-751 has only one serviceable part—an automotive type fuse, which protects the low voltage transformer from damage if the output is short-circuited. If the fuse has opened up, remove whatever caused the short circuit and replace the fuse with only a 3 Amp automotive type fuse. If the fuse does not correct the condition, replace the entire 50M56U-751 control. There are no other user serviceable parts.

Inter-purge – The period of time intended to allow for the dissipation of any unburned gas or residual products of combustion between the failed trial for ignition and the retry period.

Post-purge Time – The period of time intended to allow for the dissipation of any unburned gas or residual products of combustion at the end of a furnace burner operating cycle. Post-purge begins at the loss of flame sense.

Pre-purge Time – The period of time intended to allow for the dissipation of any unburned gas or residual products of combustion at the beginning of a furnace operating cycle prior to initiating ignition.

Recycles – The additional attempts within the same thermostat cycle for ignition after loss of the supervised ignition source or the supervised main burner flame.

Retries – The additional attempts within the same thermostat cycle for ignition when the supervised main burner flame is not proven within the first trial for ignition period.

Trial for Ignition Period (TFI) – The period of time between initiation of gas flow and the action to shut off the gas flow in the event of failure to establish proof of the supervised ignition source or the supervised main burner flame.

TROUBLESHOOTING

Red LED Flash	Error/Condition	Comments/Troubleshooting
1	External lockout (exceeded retries)	Failure to sense flame is often caused by carbon deposits on the flame sensor, a disconnected or shorted flame sensor lead or a poorly grounded furnace. Carbon deposits can be cleaned with emery cloth. Verify sensor is not contacting the burner and is located in a good position to sense flame. Check sensor lead for shorting and verify furnace is grounded properly. Verify gas supply to valve, gas valve in "On" position and appliance lighting properly. Verify flame reaches flame sensor during ignition attempts and gas pressures are correct.
2	Pressure switch stuck closed	Pressure switch stuck closed. Check switch function, verify inducer is turning off. Refer to wiring diagram, terminals PSI / PSO.
3	Pressure switch stuck open	Check pressure switch function and tubing. Verify inducer is turning on and pulling sufficient vacuum to engage switch. Refer to wiring diagram, terminals PSI / PSO. Also check low inlet gas pressure (if used).
4	Open high temperature limit switch or open rollout switch	Verify continuity through limit switch circuit. Refer to wiring diagram terminals, HLI / HLO or check open rollout switch.
5	Flame sensed with gas valve de-energized or open rollout switch	Verify the gas valve is operating and shutting down properly. Flame in burner assembly should extinguish promptly at the end of the cycle. Check orifices and gas pressure.
6	Open circuit between pin 5 and 11	Verify continuity through in 5 and 11.
7	Low flame sense current	Low flame sense current is often caused by carbon deposits on the flame sensor, a poorly grounded furnace or a mis-aligned flame sense probe. Carbon deposits can be cleaned with emery cloth. Check or improve furnace and module ground. Verify sensor is located in or very near flame as specified by the appliance manufacturer. Refer to wiring diagram FS terminal and GND.
8	Ignitor relay fault	This flash code does not indicate a broken, disconnected or shorted ignitor. It indicates the ignitor relay contacts on the ignition module are not functioning properly. Replace the ignition module.
Rapid Flash	Reversed polarity	Verify the control and furnace are properly grounded. Check and reverse polarity (primary or secondary) if incorrect.
Continuous On	Normal operation	No fault
Off	Control failure	Verify power to the control, replace control if power is at the control and no lit Red LED

TECHNICAL SUPPORT: 1-888-725-9797

White-Rodgers is a business of Emerson Electric Co.

The Emerson logo is a trademark and service mark of Emerson Electric Co.

White-Rodgers™

www.white-rodgers.com
www.emersonclimate.com



EMERSON™
 Climate Technologies