

DCJ-105 (25#B)

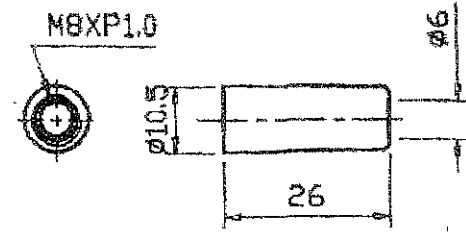

DCJ-106 (25#B)

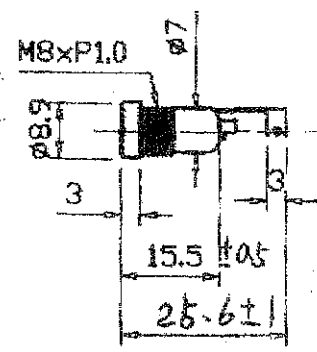
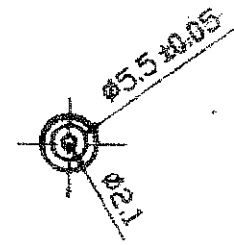
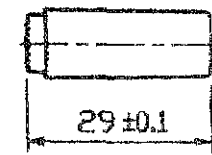
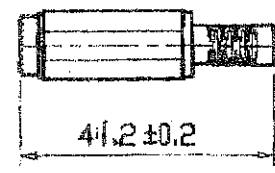
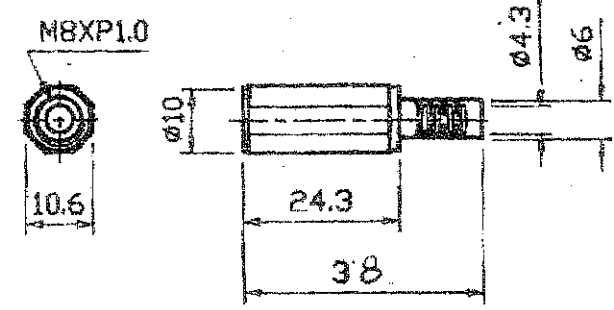
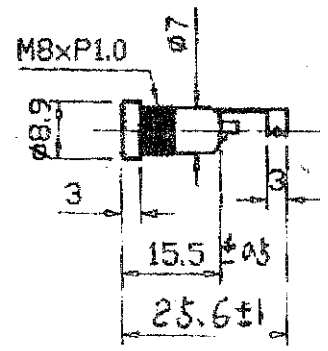
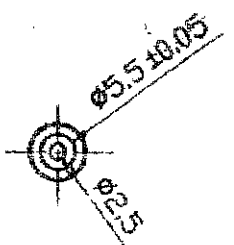

UNIT	mm	SCALE	1:1
------	----	-------	-----

MCM Electronics 27-5998 - www.mcmelectronics.com