

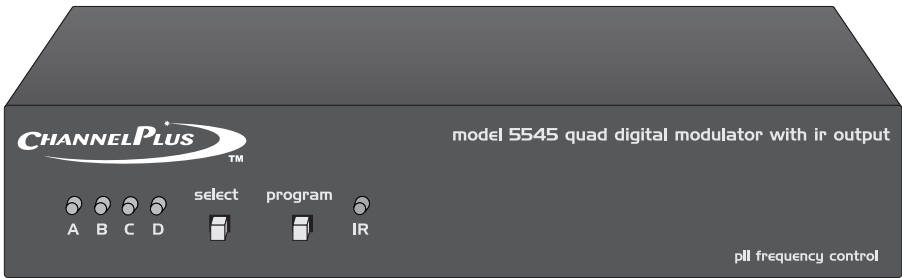

PERFORMANCE MULTI-ROOM VIDEO

Modulator Installation Manual



Frequency-Agile Multi-channel Modulators

**Models
5525/5545**

This device complies with the FCC's Part 15 Rules for TV interface devices. Any change or modification to this device without the permission of Linear LLC may void the user's authority to operate this equipment.

Linear[®]
Building On Innovation.

USA & Canada (800) 421-1587 & (800) 392-0123
(760) 438-7000 - Toll Free FAX (800) 468-1340
www.linearcorp.com

IMPORTANT SAFETY INSTRUCTIONS

- 1) Read Instructions - All the safety and operating instructions should be read before the product is operated.
- 2) Retain Instructions - The safety and operating instructions should be retained for future reference.
- 3) Heed Warnings - All warnings on the product and in the operating instructions should be adhered to.
- 4) Follow Instructions - All operating and use instructions should be followed.
- 5) Cleaning - Unplug this product from the wall outlet before cleaning. Do not use liquid cleaners or aerosol cleaners. Use a damp cloth for cleaning.
- 6) Attachments - Do not use attachments not recommended by the product manufacturer as they may cause hazards.
- 7) Water and Moisture - Do not use this product near water - for example, near a bath tub, wash bowl, kitchen sink, or laundry tub; in a wet basement; or near a swimming pool; and the like.
- 8) Accessories - Do not place this product on an unstable cart, stand, tripod, bracket, or table. The product may fall, causing serious injury to a child or adult, and serious damage to the product. Use only with a cart, stand, tripod, bracket, or table recommended by the manufacturer, or sold with the product. Any mounting of the product should follow the manufacturer's instructions, and should use a mounting accessory recommended by the manufacturer.
- 9) A product and cart combination should be moved with care. Quick stops, excessive force, and uneven surfaces may cause the product and cart combination to overturn.
- 10) Ventilation - Slots and openings in the cabinet are provided for ventilation and to ensure reliable operation of the product and to protect it from overheating, and these openings must not be blocked or covered. The openings should never be blocked by placing the product on a bed, sofa, rug, or other similar surface. This product should not be placed in a built-in installation such as a bookcase or rack unless proper ventilation is provided or the manufacturer's instructions have been adhered to.
- 11) Power Sources - This product should be operated only from the type of power source indicated on the marking label. If you are not sure of the type of power supply to your home, consult your product dealer or local power company. For products intended to operate from battery power, or other sources, refer to the operating instructions.
- 12) Grounding or Polarization - This product may be equipped with a polarized alternating-current line plug (a plug having one blade wider than the other). This plug will fit into the power outlet only one way. This is a safety feature. If you are unable to insert the plug fully into the outlet, try reversing the plug. If the plug should still fail to fit, contact your electrician to replace your obsolete outlet. Do not defeat the safety purpose of the polarized plug.
- 13) Power-Cord Protection - Power-supply cords should be routed so that they are not likely to be walked on or pinched by items placed upon or against them, paying particular attention to cords at plugs, convenience receptacles, and the point where they exit from the product.

- 14) Protective Attachment Plug - The product is equipped with an attachment plug having overload protection. This is a safety feature. See Instruction Manual for replacement or resetting of protective device. If replacement of the plug is required, be sure the service technician has used a replacement-plug specified by the manufacturer that has the same overload protection as the original plug.
- 15) Outdoors Antenna Grounding - If an outside antenna or cable system is connected to the product, be sure the antenna or cable system is grounded so as to provide some protection against voltage surges and built-up static charges. Article 810 of the National Electrical Code, ANSI/NFPA 70, provides information with regard to proper grounding of the mast and supporting structure, grounding of the lead-in wire to an antenna discharge unit, size of grounding conductors, location of antenna-discharge unit, connection to grounding electrodes, and requirements for the grounding electrode. See figure A.
- 16) Lightning - For added protection for this product during a lightning storm, or when it is left unattended and unused for long periods of time, unplug it from the wall outlet and disconnect the antenna or cable system. This will prevent damage to the product due to lightning and power-line surges.
- 17) Power Lines -An outside antenna system should not be located in the vicinity of overhead power lines or other electric light or power circuits, or where it can fall into such power lines or circuits. When installing an outside antenna system, extreme care should be taken to keep from touching such power lines or circuits as contact with them might be fatal.
- 18) Overloading - Do not overload wall outlets, extension cords, or integral convenience receptacles as this can result in a risk of fire or electric shock.
- 19) Object and Liquid Entry - Never push objects of any kind into this product through openings as they may touch dangerous voltage points or short-out parts that could result in a fire or electric shock. Never spill liquid of any kind on the product.
- 20) Servicing - Do not attempt to service this product yourself as opening or removing covers may expose you to dangerous voltage or other hazards. Refer all servicing to qualified service personnel.
- 21) Damage Requiring Service - Unplug this product from the wall outlet and refer servicing to qualified service personnel under the following conditions:
 - a) When the power-supply cord or plug is damaged,
 - b) If liquid has been spilled, or objects have fallen into the product,
 - c) If the product has been exposed to rain or water,
 - d) If the product does not operate normally by following the operating instructions. Adjust only those controls that are covered by the operating instructions as an improper adjustment of other controls may result in damage and will often require extensive work by a qualified technician to restore the product to its normal operation,
 - e) If the product has been dropped or damaged in any way, and
 - f) When the product exhibits a distinct change in performance - this indicates a need for service.
- 22) Replacement Parts - When replacement parts are required, be sure the service technician has used replacement parts specified by the manufacturer or have the same characteristics as the original part. Unauthorized substitutions may result in fire, electric shock, or other hazards.

- 23) Safety Check - Upon completion of any service or repairs to this product, ask the service technician to perform safety checks to determine that the product is in proper operating condition.
- 24) Wall or Ceiling Mounting - The product should be mounted to a wall or ceiling only as recommended by the manufacturer.
- 25) Heat - The product should be situated away from heat sources such as radiators, heat registers, stoves, or other products (including amplifiers) that produce heat.

Note to CATV system installer

This reminder is provided to call the CATV system installer's attention to Section 820-40 of the NEC which provides guidelines for proper grounding and, in particular, specifies that the cable ground shall be connected to the grounding system of the building, as close to the point of cable entry as practical.

POWER SUPPLY REPLACEMENT

Replace defective power supplies only with parts specified by the manufacturer.

Figure A

Example of antenna grounding as per
National Electrical Code, ANSI NFPA 70

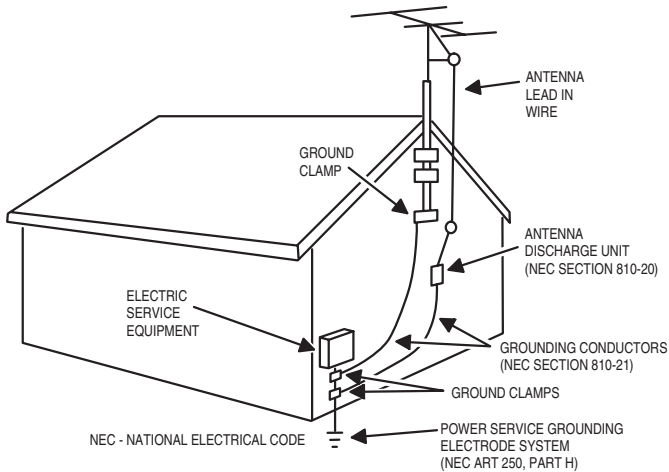

The **ChannelPlus 5500 Series** are digitally-tuned video modulators that convert any baseband video and audio signal to a user-selected UHF, or Ultraband CATV. An internal quartz crystal reference oscillator and PLL circuitry ensure drift-free performance. The user selects the output frequency (channel) using the "**select**" button to choose which modulator and the "**program**" button to enter the number of the desired channel. Any TV connected to the output via coax can receive the signals, when the TV is tuned to the proper channel.

Models available:

- 5525 2 channel modulator with IR
- 5545 4 channel modulator with IR

Controls and Connections:

(Model 5545 shown)

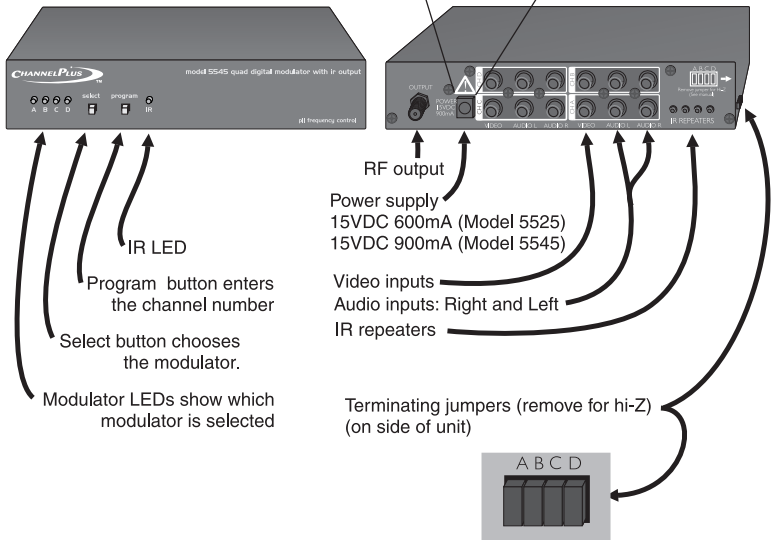
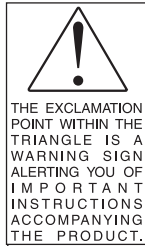

IR LED
 Program button enters the channel number
 Select button chooses the modulator.
 Modulator LEDs show which modulator is selected

RF output
 Power supply
 15VDC 600mA (Model 5525)
 15VDC 900mA (Model 5545)
 Video inputs
 Audio inputs: Right and Left
 IR repeaters

Terminating jumpers (remove for hi-Z)
 (on side of unit)

Option:

To connect the video and audio to a local monitor, use RCA type "Y" adaptors and remove the 'LOOP' jumper for corresponding channel.



Sample System Diagram

In this system, CATV or antenna channels are available on all TVs. In addition the following channels have been added:

- Channel 66 - Front door channel
- Channel 68 - VCR
- Channel 70 - Satellite receiver
- Channel 72 - DVD player

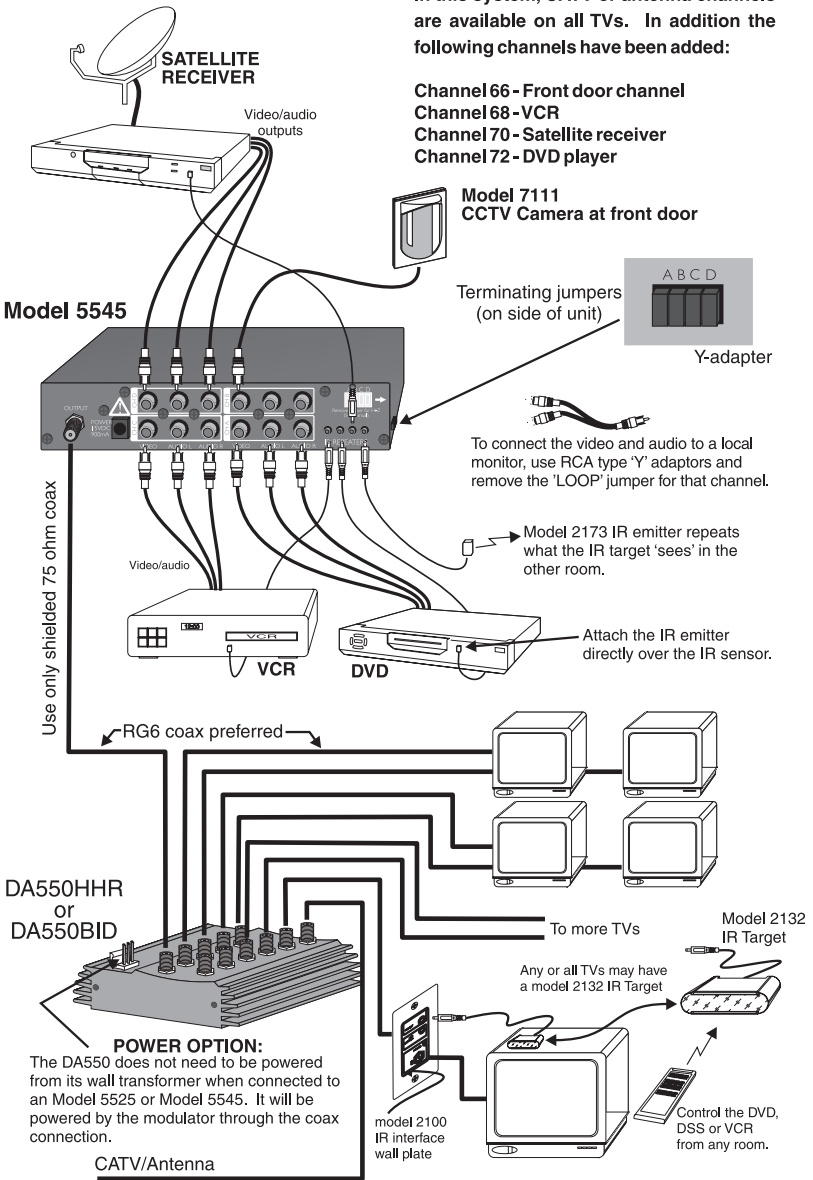

Programming Examples:

To program modulator **B** to channel **67**

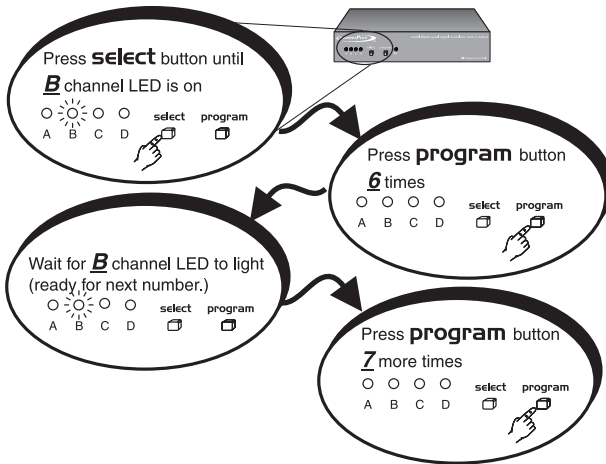

To program modulator **C** to channel **120**

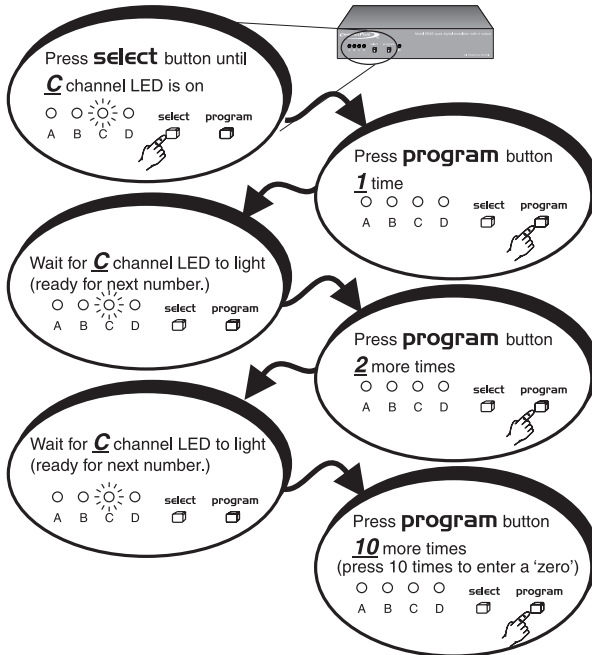

Valid Channels: 14-64: UHF channels
 65-125: CATV channels
 95-99: not valid

Channel Spacing: Skip at least one number between channels.
 Channels 14 and 16: OK.
 Channels 14 and 15: Illegal.

Error indication: If an error has occurred or an incorrect channel is entered, the LED will flash quickly for a second and return to the previous settings.

If two adjacent channels are selected, the unit will accept the entry but will blink the LEDs of channels that are too close. If this happens, re-program one of the channels to move it away from the other.

Channel number readback: A readback mode will display the current channel assignments.

To readback modulator **C** channel assignment
 (example: C has been programmed to channel **108**)

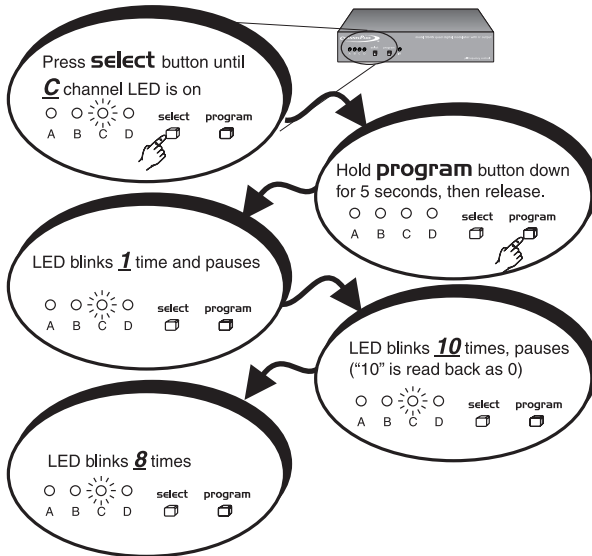

Things to watch for:

No picture ... Verify that the video source is on and is producing a video signal. Check that the TV and the modulator are tuned to the same channel. For example, if the modulator is broadcasting on UHF channel 16, make sure the TV is on UHF 16 rather than CATV 16. UHF 16 and CATV 16 are at different frequencies.

Weak ChannelPlus UHF channel ... If the TV has a separate UHF input, be sure that it is connected.

LEDs blink ... You need to have one unused channel space between channels. The display will blink if you have made an 'illegal' choice. See the section on programming.

Herringbone interference on ChannelPlus channel (diagonal lines) ... You may have chosen a channel number that is not completely vacant. Distant UHF stations may be un-watchable, but will cause interference if you try to create a new channel at the same frequency. Also, cable companies often have extra signals where there should be none. Try moving the ChannelPlus channel to another number. You may have to add a low pass filter to remove cable company noise.

Herringbone interference on many channels (disappears when you remove the modulator) ... The high output of the ChannelPlus modulator can overdrive many RF amplifiers. Reduce the RF output using an attenuator. (ChannelPlus coax panels are designed to take the full output of these modulators.)

Audio volume is low ... The left and right audio inputs are combined for monaural. For proper audio level, both right and left inputs must be used. If you have a mono source, connect it to both right and left inputs using an RCA 'Y' connector.

No color on ChannelPlus channels ... You may have chosen the incorrect cable standard. Not all televisions can accommodate the 1.25MHz frequency difference between the H and I cable standards. See the section

Changing modulation standards

Cable HRC and IRC considerations

Most cable services use IRC frequency assignments. This is the default for the ChannelPlus 5500 series modulators. However, if the cable service uses HRC or the TV appears to search for the "house channels," the modulator can be reprogrammed to use HRC assignments by entering the number "98". Set to IRC by entering a "99". Both of these settings are only used for setting HRC/IRC. **Note:** This setting can be entered on any modulator channel, A, B, C, or D, and affects all channel assignments for that unit. Cable channels must either be all IRC or all HRC.

Specifications: typical @ 25°C ± 5°C

5500 Series modulators

Model		5525	5545
Inputs	video	1 Vp-p @ 75 Ω	
	audio	1 V rms @ 47k Ω	
		L & R inputs combined for monaural	
Video performance	differential gain	4%	
	differential phase	<4°	
	signal/noise	55 dB	
RF output	UHF	Channel 14 - 64	
	CATV	Channel 65-125 (excluding 95-99)	
	output level	+25 dBmV (85dBμV)	
	IM distortion	-60 dBC	
	alternate channel	-45dBC @ 12MHz	
Power supply	model number	350-079	350-082
	output current	600mA	900mA
	output voltage	15 VDC	
	input voltage	105-125 VAC	

Physical dimension: 1.5" (3.8 cm) height x 7.97" (20.2 cm) width x 5.54" (14.1 cm) depth

Weight: 2 lbs

DECLARATION OF CONFORMITY

THIS DEVICE COMPLIES WITH PART 15 OF THE FCC RULES. OPERATION IS SUBJECT TO THE FOLLOWING TWO CONDITIONS: (1) THIS DEVICE MAY NOT CAUSE HARMFUL INTERFERENCE, AND (2) THIS DEVICE MUST ACCEPT ANY INTERFERENCE RECEIVED, INCLUDING INTERFERENCE THAT MAY CAUSE UNDESIRE OPERATION.

Installation requirements:

FCC classifies this product under part 15 of its rules as a "television interface device".

Systems designed using television interface devices have the following legal requirements:

- 1) The modulated channel signal strength may not exceed 15.56dBmV at any television.
Federal Regulation 47CFR15.115(b)(1)(i).
- 2) If an antenna is used in the system, the modulated channel signal strength may not exceed -51dBmV at the antenna input port. *Federal Regulation 47CFR15.115(c)(4).*

For the Installer:

The system you design must comply with these regulations. As the installer, you are responsible. The easiest way to be fully compliant is to use a ChannelPlus coax panel. ChannelPlus panels have the necessary isolation from the modulator input ports to the antenna input port and gain characteristic from the modulator input ports to the television output ports. These features will make your modulator comply with the above requirements.

The **Typical Installation** shown is fully compliant.

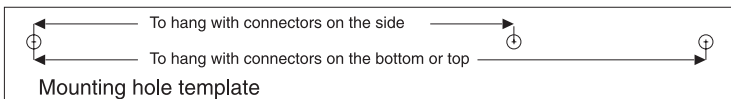

Notes:

LIMITED WARRANTY STATEMENT

Linear LLC warrants this product to be free from defects in material and workmanship for 2 years. The time period will be measured using the date code labeled on the product. Linear LLC is not responsible for damage to the product resulting from the buyer's improper handling, stocking or warehousing of the product. Any implied warranty arising from the sale of the product including implied warranties of merchantability and fitness for purpose are limited. Linear LLC shall not be responsible for any losses, damages or expenses, whether direct, consequential, or incidental arising from the use or the inability to use the product. Some states and countries do not allow limitations or how long an implied warranty lasts or the exclusion or limitation or incidental or consequential damages, so the above exclusions may not apply. The Linear LLC warranty gives specific legal rights in addition to other rights, which may exist and vary from state to state and country to country.

The warranty is limited to repair or replacement of products returned, freight prepaid, to Linear LLC, there is NO PROVISION FOR LABOR COST OR OTHER REIMBURSEMENTS OF ANY KIND.

1. Failures due to product abuse, such as negligence, improper use, and electrical surge including damage from lightning, water damage or other damage due to natural disasters are not covered by the warranty. The most common form of product abuse is surge damage caused by lightning.
2. The warranty shall also be voided by any tampering with the date code, labels or other markings on the product.
3. Products that are damaged in transit to Linear LLC due to improper packaging or by the carrier (shipping company) will not be covered under the warranty. If the product was damaged or lost by the carrier, it is the sender's responsibility to create a claim against the carrier.
4. The user is responsible for all labor costs associated with removing, reinstalling and returning the product to Linear LLC.

Linear LLC, at its option, will repair or replace the defective product. Replacements will be made from B-Stock, if an exact replacement is not available, Linear LLC, at its option, will select the nearest equivalent product. The user is responsible for freight charges to Linear LLC. Linear LLC will return warranted repaired or replacements by UPS Ground or an equivalent service. A customer may pay the additional costs for second-day or next-day service.

All products returned for warranty service require a Return Product Authorization Number (RPA#). Contact Linear Technical Services at 1-800-421-1587 for an RPA# and other important details.