

PUBLIC ADDRESS SYSTEM

MPA-20  
MPA-40  
MPA-60  
MPA-120  
MIXER AMPLIFIER

OPERATION MANUAL

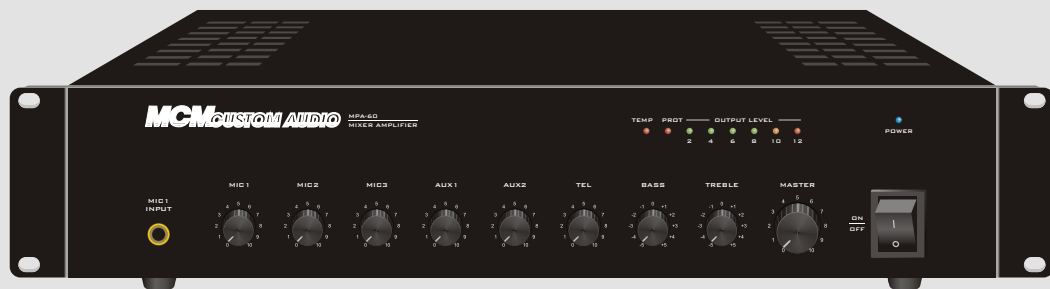

Please follow the instructions in this manual to obtain the optimum results from this unit.  
We also recommend that you keep this manual handy for future reference.

## TABLE OF CONTENTS

<b>SAFETY PRECAUTIONS .....</b>	<b>3</b>
<b>MPA-20,MPA-40</b>	
<b>1. FEATURES.....</b>	<b>5</b>
<b>2. NOMENCLATURE AND FUNCTIONS.....</b>	<b>6</b>
<b>2.1 FRONT PANEL.....</b>	<b>6</b>
<b>2.2 REAR PANEL.....</b>	<b>7</b>
<b>3. CONNECTIONS.....</b>	<b>8</b>
<b>4. MACHINE OPERATION.....</b>	<b>9</b>
<b>5. APPLICATIONS.....</b>	<b>10</b>
<b>6. BLOCK DIAGRAM.....</b>	<b>11</b>
<b>7. SPECIFICATIONS.....</b>	<b>12</b>
<b>8. DIMENSIONAL DIAGRAM.....</b>	<b>13</b>
<b>MPA-60,MPA-120</b>	
<b>1. FEATURES.....</b>	<b>14</b>
<b>2. NOMENCLATURE AND FUNCTIONS.....</b>	<b>15</b>
<b>2.1 FRONT PANEL.....</b>	<b>15</b>
<b>2.2 REAR PANEL.....</b>	<b>16</b>
<b>3. CONNECTIONS.....</b>	<b>17</b>
<b>4. MACHINE OPERATION.....</b>	<b>18</b>
<b>5. APPLICATIONS.....</b>	<b>19</b>
<b>6. BLOCK DIAGRAM.....</b>	<b>20</b>
<b>7. SPECIFICATIONS.....</b>	<b>21</b>
<b>8. DIMENSIONAL DIAGRAM.....</b>	<b>22</b>

## SAFETY PRECAUTIONS

- Be sure to read the instructions in this section carefully before use.
- Make sure to observe the instructions in this manual as the conventions of safety symbols and messages regarded as very important precautions are included.
- We also recommend you keep this instruction manual handy for future reference.

### Safety Symbol and Message Conventions

Safety symbols and messages described below are used in this manual to prevent bodily injury and property damage which could result from mishandling. Before operating your product, read this manual first and understand the safety symbols and messages so you are thoroughly aware of the potential safety



### WARNING

Indicates a potentially hazardous situation which, if mishandled, could result in death or serious personal injury.



### CAUTION

Indicates a potentially hazardous situation which, if mishandled, could result in moderate or minor personal injury, and/or property damage.



### WARNING

#### When Installing the Unit

- Do not expose the unit to rain or an environment where it may be splashed by water or other liquids, as doing so may result in fire or electric shock.
- Use the unit only with the voltage specified on the unit. Using a voltage higher than that which is specified may result in fire or electric shock.
- Do not cut, kink, otherwise damage nor modify the power supply cord. In addition, avoid using the power cord in close proximity to heaters, and never place heavy objects -- including the unit itself -- on the power cord, as doing so may result in fire or electric shock.
- Be sure to replace the unit's terminal cover after connection completion. Because high voltage is applied to the speaker terminals, never touch these terminals to avoid electric shock.
- Be sure to ground to the safety ground (earth) terminal to avoid electric shock. Never ground to a gas pipe as a catastrophic disaster may result.
- Avoid installing or mounting the unit in unstable locations, such as on a rickety table or a slanted surface. Doing so may result in the unit falling down, causing personal injury and/or property damage.

#### When the Unit is in Use

- Should the following irregularity be found during use, immediately switch off the power, disconnect the power supply plug from the AC outlet and contact your nearest dealer. Make no further attempt to operate the unit in this condition as this may cause fire or electric shock.
  - If you detect smoke or a strange smell coming from the unit.
  - If water or any metallic object gets into the unit
  - If the unit falls, or the unit case breaks
  - If the power supply cord is damaged (exposure of the core, disconnection, etc.)
  - If it is malfunctioning (no tone sounds.)
- To prevent a fire or electric shock, never open nor remove the unit case as there are high voltage components inside the unit. Refer all servicing to your nearest dealer.
- Do not place cups, bowls, or other containers of liquid or metallic objects on top of the unit. If they accidentally spill into the unit, this may cause a fire or electric shock.
- Do not insert nor drop metallic objects or flammable materials in the ventilation slots of the unit's cover, as this may result in fire or electric shock.

### CAUTION

#### When Installing the Unit

- Never plug in nor remove the power supply plug with wet hands, as doing so may cause electric shock.
- When unplugging the power supply cord, be sure to grasp the power supply plug; never pull on the cord itself. Operating the unit with a damaged power supply cord may cause a fire or electric shock.
- When moving the unit, be sure to remove its power supply cord from the wall outlet. Moving the unit with the power cord connected to the outlet may cause damage to the power cord, resulting in fire or electric shock. When removing the power cord, be sure to hold its plug to pull.
- Do not block the ventilation slots in the unit's cover. Doing so may cause heat to build up inside the unit and result in fire.
- Avoid installing the unit in humid or dusty locations, in locations exposed to the direct sunlight, near the heaters, or in locations generating sooty smoke or steam as doing otherwise may result in fire or electric shock.

#### When the Unit is in Use

- Do not place heavy objects on the unit as this may cause it to fall or break which may result in personal injury and/or property damage. In addition, the object itself may fall off and cause injury and/or damage.
- Make sure that the volume control is set to minimum position before power is switched on. Loud noise produced at high volume when power is switched on can impair hearing.
- Do not operate the unit for an extended period of time with the sound distorting. This is an indication of a malfunction, which in turn can cause heat to generate and result in a fire.
- Contact your dealer as to the cleaning. If dust is allowed to accumulate in the unit over a long period of time, a fire or damage to the unit may result.
- If dust accumulates on the power supply plug or in the wall AC outlet, a fire may result. Clean it periodically. In addition, insert the plug in the wall outlet securely.
- Switch off the power, and unplug the power supply plug from the AC outlet for safety purposes when cleaning or leaving the unit unused for 10 days or more. Doing otherwise may cause a fire or electric shock.

An all-pole mains switch with a contact separation of at least 3 mm in each pole shall be incorporated in the electrical installation of the building.

## 1. FEATURES

1. Rated Power:20W and 40W.
2. 100V,70V constant voltage outputs and 4~16Ohms constant resistance output.
3. 1 channel MIC2 one-port input (5mv 1Kohms) and 1 channel (300mv 10Kohms) AUX input
4. 1 channel MIC1 balanced/unbalanced input (2.5/5mv 1/2Kohms)
5. 1 channel TEL input (sensitivity 350mV/10Kohms)
6. Built in treble and bass adjustment  
bass: +/-10dB @ 100Hz  
treble: +/- 10dB @ 10KHz
7. Built in priority functions. Priority level is as follows:  
Aux is default signal  
MIC1 input will override MIC2 and Aux inputs  
Telephone input will override both MIC1, MIC2 and AUX inputs

## 2. NOMENCLATURE AND FUNCTIONS

### 2.1 20W/40W FRONT PANEL

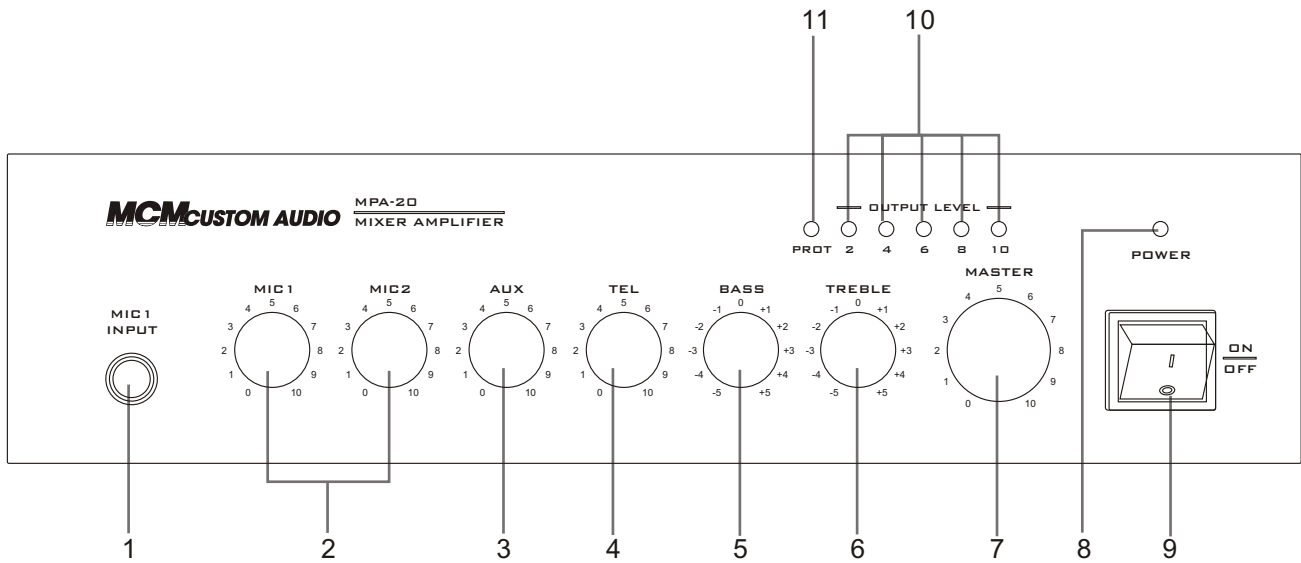

#### 1. MIC1 INPUT

MIC1 input Microphone jack input

#### 2. MIC1 MIC2

MIC volume control (MIC1/MIC2)

#### 3. AUX

AUX volume control

#### 4. TEL

TEL volume control

#### 5. BASS

Adjust bass response. Rotate clockwise to increase bass output and anticlockwise to reduce it.

#### 6. TREBLE

Adjust treble response. Rotate clockwise to increase treble output and anticlockwise to reduce it.

#### 7. MASTER

Master volume control

#### 8. POWER

Power indicator

#### 9. POWER SWITCH

On top of the opening Power

Press the end, power shut down

#### 10. LEVEL INDICATORS

Level meters 5 output level indicators

#### 11. PROTECTION

When the machine is in protection status, this indicator will be lit: in normal operation status, the LED is off. If the product is in protection status due to overheating, overload or direct current, the indication LED will be lit while the output relay will be disconnected. (Signal indicator is just used to indicate the use of input music signal. In the protection status, signal indicator is still lit according to the size of input signal.)

# NOMENCLATURE AND FUNCTIONS

## 2.2 20W/40W REAR PANEL

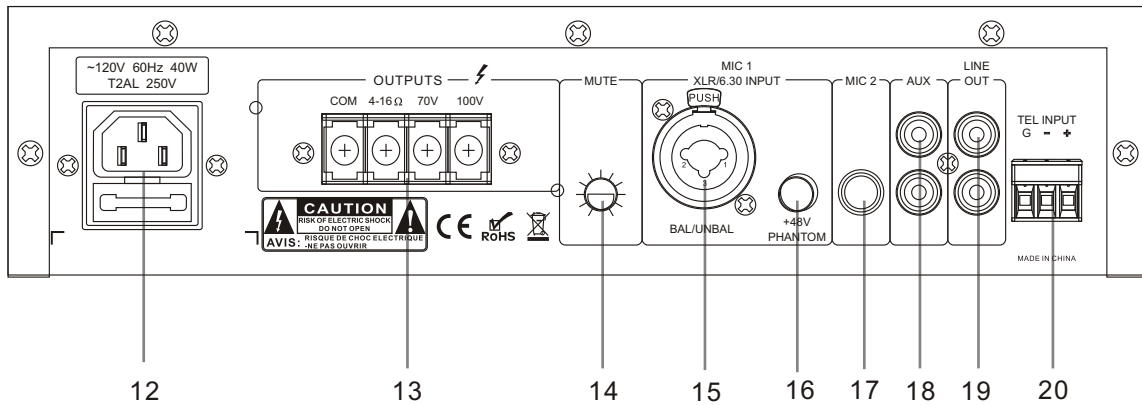

### 12. ~120V 60Hz AC POWER INPUT

### 13. SPEAKER TERMINALS

Connectors for 4-16 ohms or 70V and 100V speaker

### 14. Mute adjust

Adjust the mute degree from 0-30dB when MIC1 input override all the other inputs( except TEL).

### 15. MIC input with phantom power

MIC1 input compatible of XLR and stereo connector

### 16. MIC 1 PHANTOM +48V Power switch

### 17. MIC 2 MIC input

MIC2 input of Microphone

### 18. AUX input

AUX for extra equipment input

### 19. Line output

Connect to other audio processing equipments

### 20. TEL INPUT

## 3. CONNECTIONS

### 3.1 SPEAKER CONNECTIONS

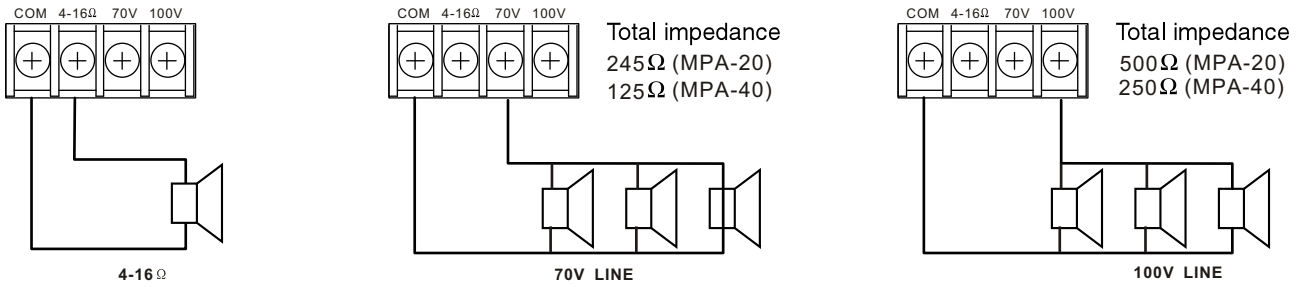

#### Notes

- Both the 4 – 16 Ω and 70V/100V terminals cannot be used at the same time.
- Impedances indicated in the figures represent the total speaker system (load) impedances.

## WARNING

Be sure to attach the supplied terminal cover after connection completion. Because high voltage is applied to the speaker terminals, never touch these terminals to avoid electric shock.

- 3.2 The combination input accepts either XLR or 1/4" microphone plugs. 1/4" sources can be either balanced or unbalanced as shown.

#### Balanced Connections

- XLR type male connector

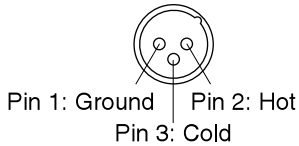

- Phone plug

Sleeve: Ground

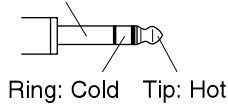

#### Unbalanced Connections

- Phone plug

Sleeve: Ground

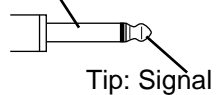



## 4. MACHINE OPERATION

### OPERATION ATTENTION

The four output connectors only can choose two connectors work together. If voltage is 70V/100V, the speakers must be with transformer and make sure the total power wattage of speaker is 15% less than the power wattage of amplifier.

### GUIDANCE OF EXCLUDING ERRORS

Phenomena	Cause
All the wires are connected well but no voice output	1 No power or wrong plug connection 2 Fuse is burned 3 Volume is town off 4 No input signal
Power on but alarming signal	1 Overloading or short circuit 2 Voltage is not stable, too high or low
No voice output in normal condition	1 Machine is in protection condition in case of high temperature 2 Wrong wire connection

### MUTE FUNCTION

- 1 Tel has priority over all inputs.
- 2 MIC 1 is second priority, adjust mute electric potential can override other input signal except tel signal.
- 3 It is the same level of MIC 1, when one of the two port connect with MIC, another connect MIC port is in vain.

# 5. APPLICATIONS

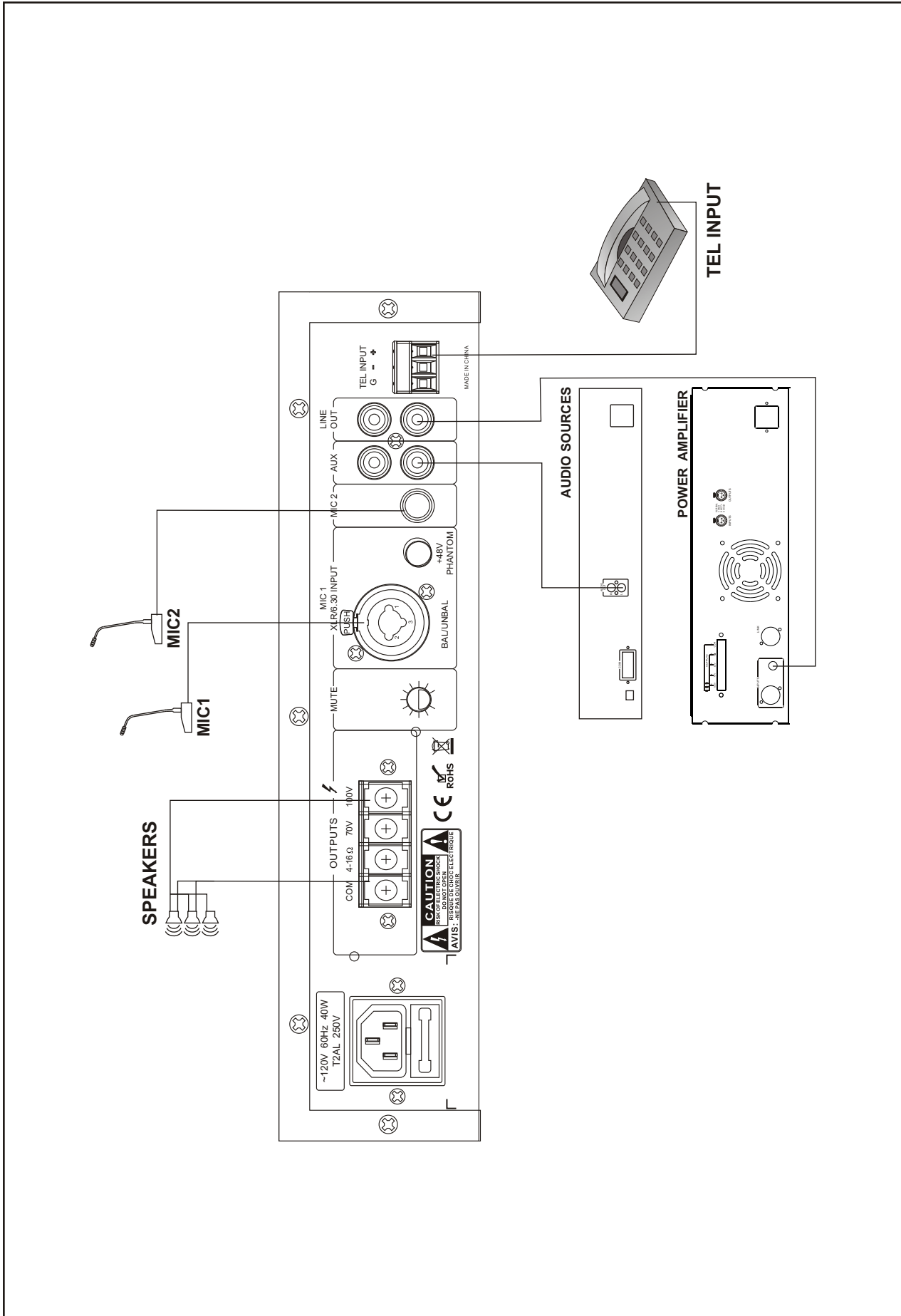

# 6. BLOCK DIAGRAM

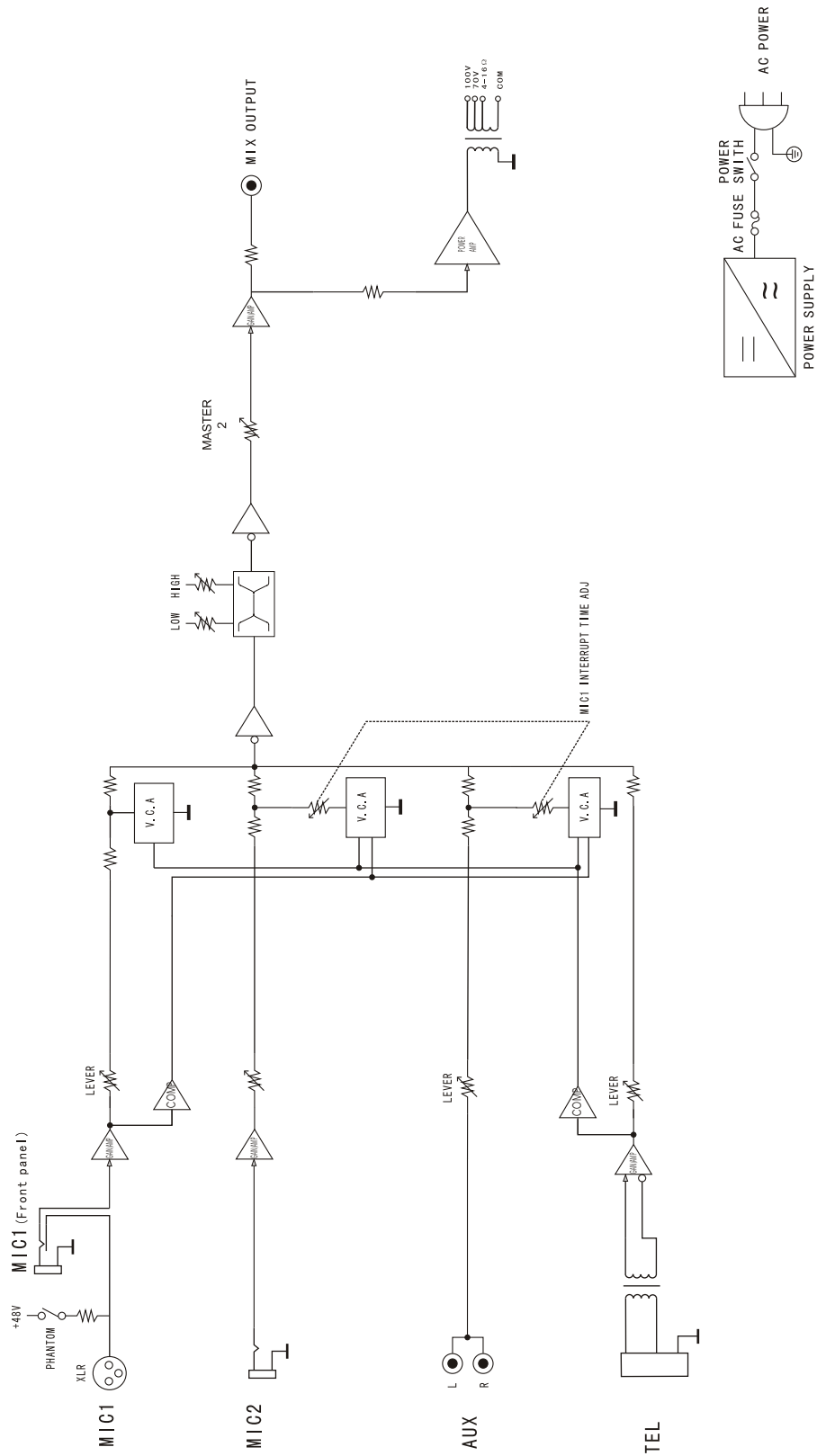

## 7. SPECIFICATIONS

MIXER AMPLIFIER WITH CD		
Model	MPA-20	MPA-40
Rated Power Output	20W	40W
Speaker Line Input	4~16Ω, 70V, 100V	
S/N	MIC:66dB;AUX:80dB	
Frequency response(At 1KHz Half power output, -3dB)	80Hz~16KHz	
Tone control(Bass:100Hz, Treble:10KHz)	±10dB	
Input sensitivity/impedance	MIC1、2; 5mV/1Kohms AUX:350mV/10Kohms TEL:350mV/10Kohms	
MIC 1~2 input section(CH1~2 in@1KHz, preamp out)		
Input sensitivity/impedance	5mV/1Kohms	
AUX 1 input section(AUX in@1KHz, preamp out)		
Input sensitivity/impedance	350mV/10Kohms	
TEL input section(TEL in@1KHz, preamp out)		
Input sensitivity/impedance	350mV/10Kohms	
Phantom power	+48VDC	
Line Out	1000mV/470ohms	
Total harmonic distortion	Less than 0.5%	
Muting function	TEL takes precedence over all the audio input MIC1 prior to the other audio input (except TEL)	
Channel crosstalk(Separation)	50dB	
Cooling mode	Air cooling	
Power source	~120V 60Hz	
Power consumption	45W	60W
Net weight	3.6Kg	4.5Kg
Dimensions(mm)	276X245X70	

## 8. DIMENSIONAL DIAGRAM

UNIT:mm

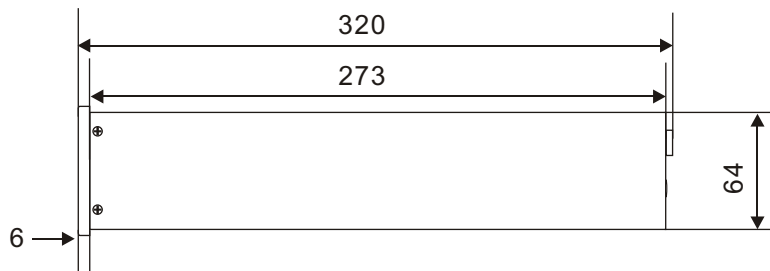
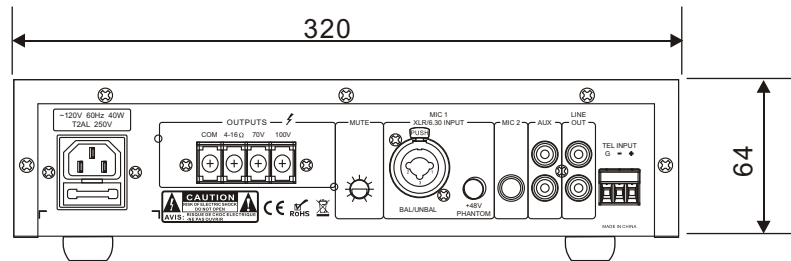
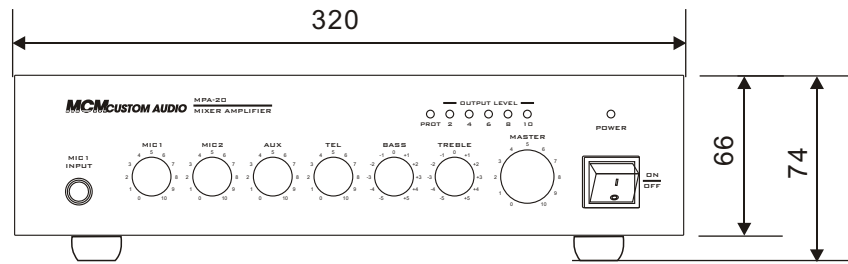

Keep the unit's all sides over 10 cm away from objects that may obstruct air flow to prevent the unit's internal temperature rise.

UNIT:mm

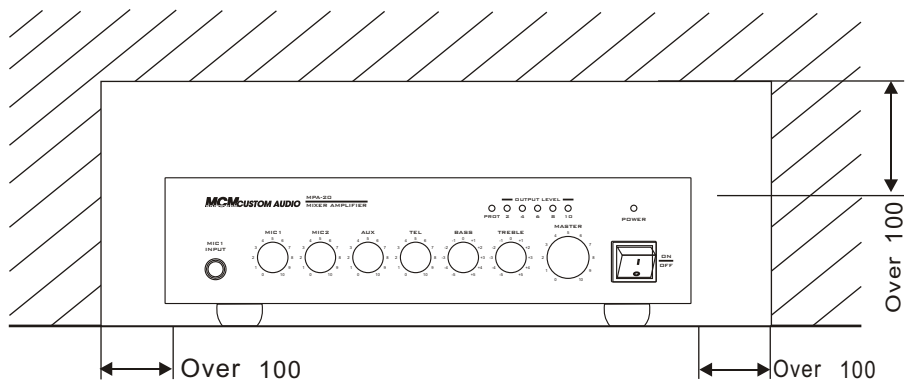

## 1. FEATURES

1. Rated Power:60W \120W.
2. 100V,70V constant voltage outputs and 4~16Ohms constant resistance output.
3. Commercial-grade torroidal transformers produce high performance audio on a wide range of frequencies with min noise and high fidelity, even at high volume.
4. Reliable protection against overload, short circuit, and power fluctuation for optimum reliability.
5. VOX feature mutes AUX inputs when input is detected on MIC 1. Time Adjust control allows resumption of music to be sharp or gradual.
6. Phantom power available on MIC 1 input for condenser-type microphones.
7. Built in treble and bass adjustment  
bass: +/-10dB @ 100Hz  
treble: +/- 10dB @ 10KHz
8. Built in priority functions. Priority level is as follows:  
Aux is default signal  
MIC1 input will override MIC2, MIC3 and Aux inputs  
Telephone input will override MIC1, MIC2, MIC3 and AUX inputs

## 2. NOMENCLATURE AND FUNCTIONS

### 2.1 60W/120W FRONT PANEL

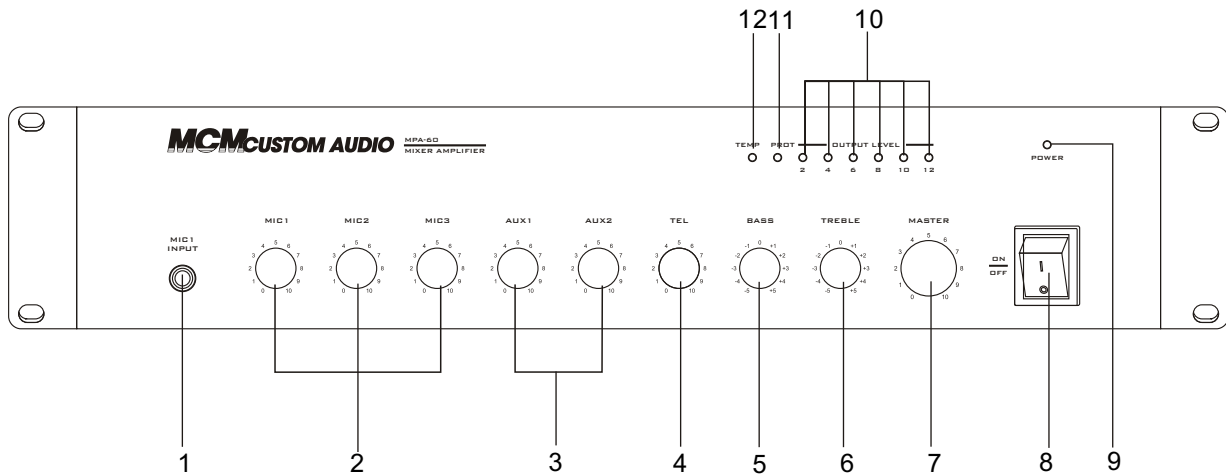

#### 1. MIC1 INPUT

MIC1 input 6.3 Microphone jack input

#### 2. MIC1 \MIC2 \MIC3

MIC volume control (MIC1/MIC2/MIC3)

#### 3. AUX1 \AUX2

AUX volume control(AUX 1/AUX 2)

#### 4. TEL

TEL volume control

#### 5. BASS

Adjust bass response. Rotate clockwise to increase bass output and anticlockwise to reduce it.

#### 6. TREBLE

Adjust treble response. Rotate clockwise to increase treble output and anticlockwise to reduce it.

#### 7. MASTER

Master volume control

#### 8. POWER SWITCH

On top of the opening Power  
Press the end, power shut down

#### 9. POWER

Power indicator

#### 10. LEVEL INDICATORS

Level meters 6 output level indicators

#### 11. PROTECTION

When the machine is in protection status, this indicator will be lit: in normal operation status, the LED is off. If the product is in protection status due to overheating, overload or direct current, the indication LED will be lit while the output relay will be disconnected. (Signal indicator is just used to indicate the use of input music signal. In the protection status, signal indicator is still lit according to the size of input signal.)

#### 12. TEMP

Temperature Indicator

# NOMENCLATURE AND FUNCTIONS

## 2.2 60W/120W REAR PANEL

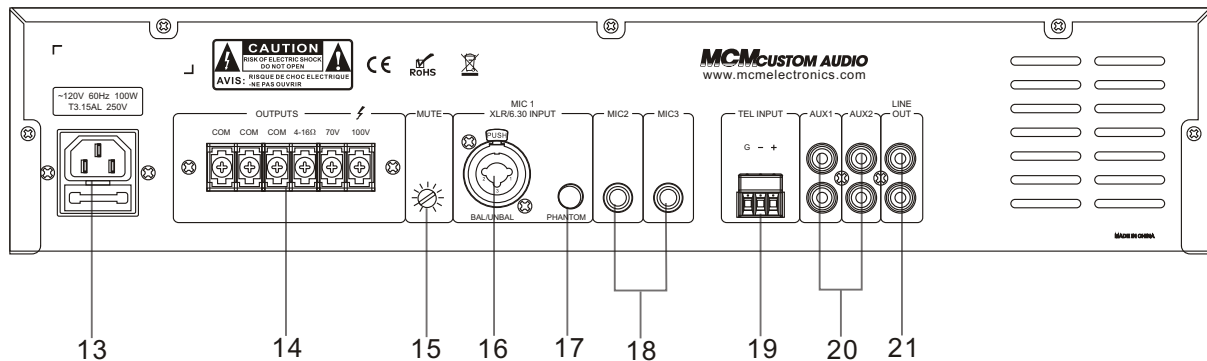

### 13. ~ 120V 60Hz POWER INPUT

### 14. SPEAKER TERMINALS

Connectors for 4-16 ohms or 70V and 100V speaker

### 15. Mute adjust

Adjust the mute degree from 0-20dB when MIC1 input override all the other inputs.

### 16. MIC input with phantom power

MIC1 input compatible of XLR and 6.3 MIC

### 17. Phantom power switch

### 18. (MIC 2, MIC 3) MIC input

MIC2-3 input of 6.3 MIC

### 19. TEL INPUT

### 20. (AUX 1, AUX 2) AUX input

AUX 2-3 for extra equipment input

### 21. Line output

Connect to other audio processing equipments



## 3. CONNECTIONS

### 3.1 SPEAKER CONNECTIONS

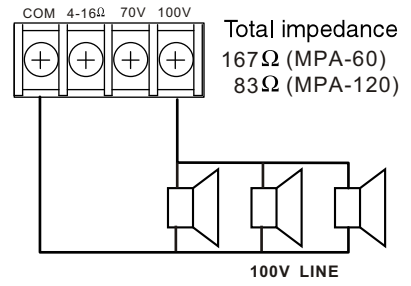
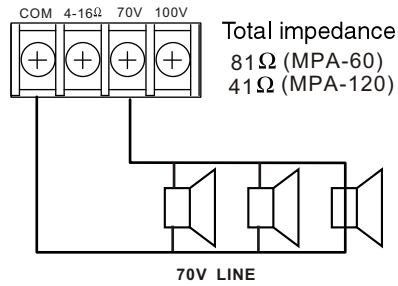
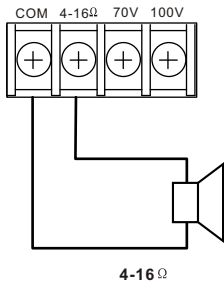

#### Notes

- Both the 4 – 16  $\Omega$  and 70V/100 V terminals cannot be used at the same time.
- Impedances indicated in the figures represent the total speaker system (load) impedances.

## WARNING

Be sure to attach the supplied terminal cover after connection completion. Because high voltage is applied to the speaker terminals, never touch these terminals to avoid electric shock.

- 3.2 The combination input accepts either XLR or 1/4" microphone plugs. 1/4" sources can be either balanced or unbalanced as shown.

#### Balanced Connections

- XLR type male connector

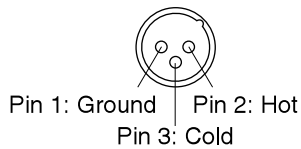

- Phone plug

Sleeve: Ground

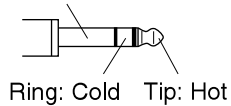

#### Unbalanced Connections

- Phone plug

Sleeve: Ground

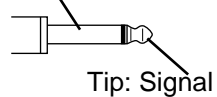

## 4. MACHINE OPERATION

### OPERATION ATTENTION

The four output connectors only can choose two connectors work together. If voltage is 70V/100V, the speakers must be with transformer and make sure the total power wattage of speaker is 15% less than the power wattage of amplifier.

### GUIDANCE OF EXCLUDING ERRORS

Phenomena	Cause
All the wires are connected well but no voice output	1 No power or wrong plug connection 2 Fuse is burned 3 Volume is town off 4 No input signal
Power on but alarming signal	1 Overloading or short circuit 2 Voltage is not stable, too high or low
No voice output in normal condition	1 Machine is in protection condition in case of high temperature 2 Wrong wire connection

### MUTE FUNCTION

- 1 Tel has priority over all inputs.
- 2 MIC 1 is second priority, adjust mute electric potential can override other input signal except tel signal.
- 3 It is the same level of MIC 1, when one of the two port connect with MIC, another connect MIC port is in vain.

## 5. APPLICATIONS

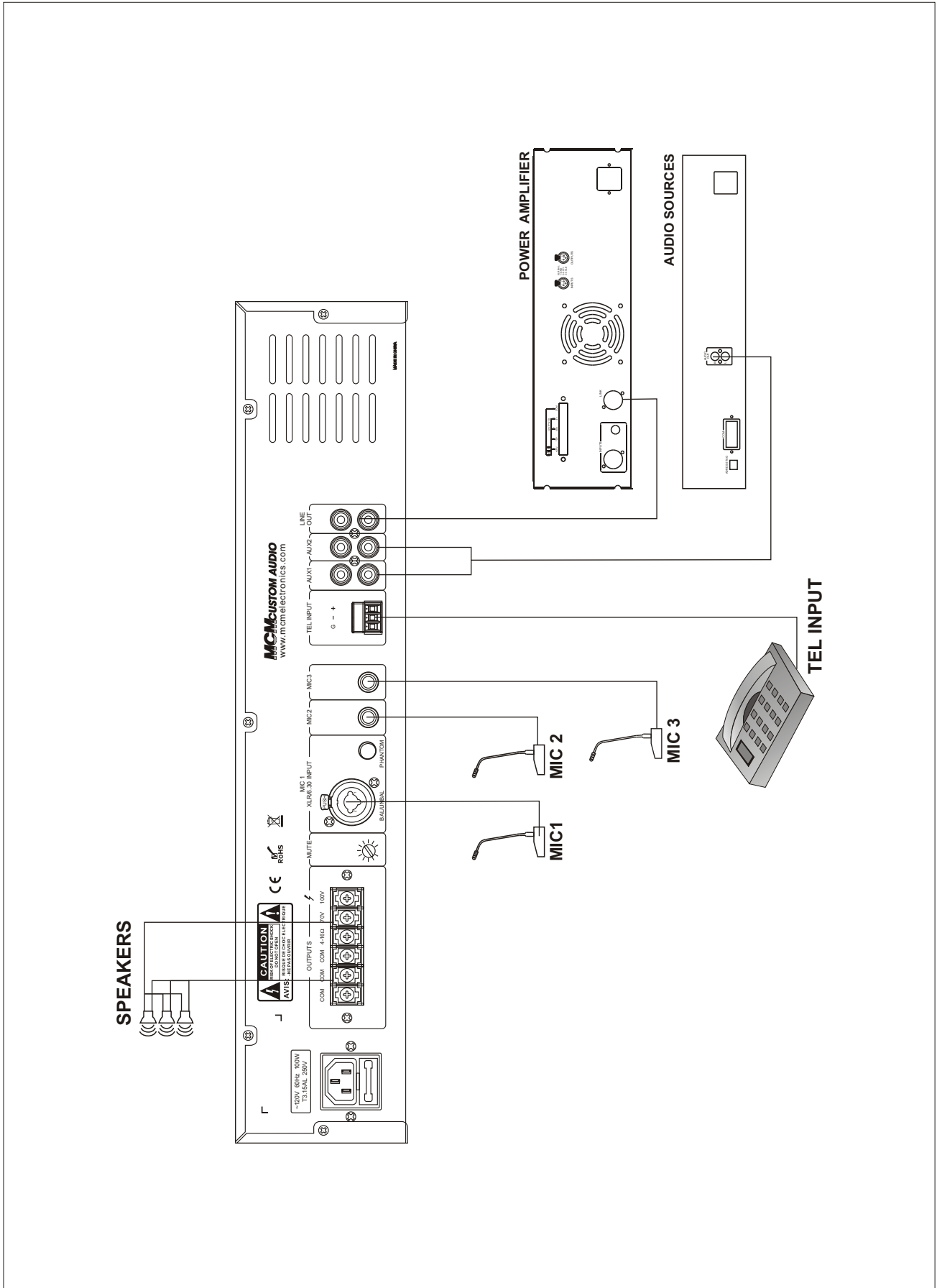

# 6. BLOCK DIAGRAM

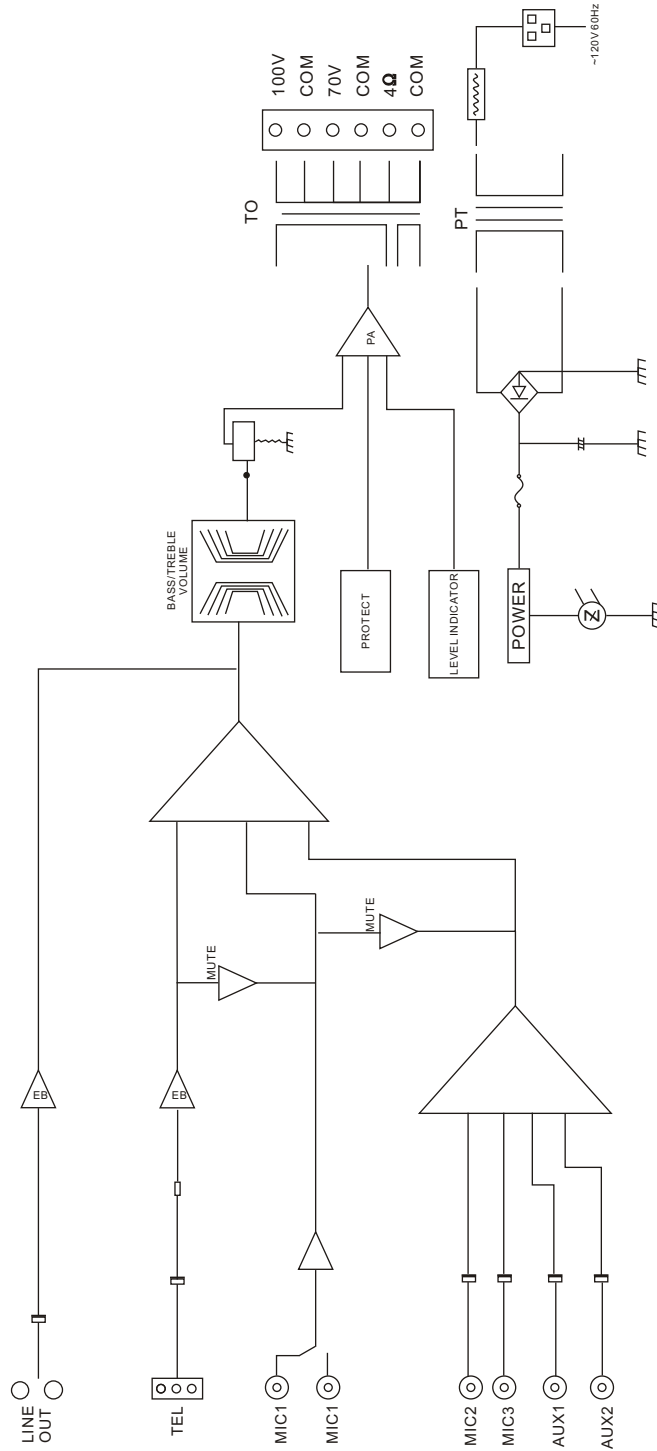

## 7. SPECIFICATIONS

MIXER AMPLIFIER WITH CD		
Model	MPA-60	MPA-120
Rated Power Output	60W	120W
Speaker Line Input	4~16Ω, 70V, 100V	
Input sensitivity/impedance	MIC1、2、3: 5mV/600ohms AUX:350mV/10Kohms	
S/N	Better than 90dB	
Frequency response(At 1KHz Half power output, +3dB)	50Hz~18KHz	
MIC 1~2 input section(CH1~2 in@1Khz, preamp out)		
Input sensitivity/impedance	5mV/600ohms	
S/N	Better than 62dB	
Tone control(Bass:100KHz, Treble:10KHz)	+12dB	
Phantom power	+48VDC	
AUX 1 input section(AUX in@1Khz, preamp out)		
Input sensitivity/impedance	350mV/10Kohms	
S/N	Better than 76dB	
Frequency Response(+3dB)	50Hz~18KHz	
Tone control(Bass:100KHz, Treble:10KHz)	+12dB	
Pre Amp Out	5dBV/600ohms	
Total harmonic distortion	Less than 0.3%	
Line level output	~10dB/3Kohms	
Cooling mode	Air cooling	
Power source	~120V 60Hz	
Power consumption	100W	200W
Net weight	6.7Kg	7.8Kg
Dimensions(mm)	484 x303x88	

## 8. DIMENSIONAL DIAGRAM

UNIT:mm

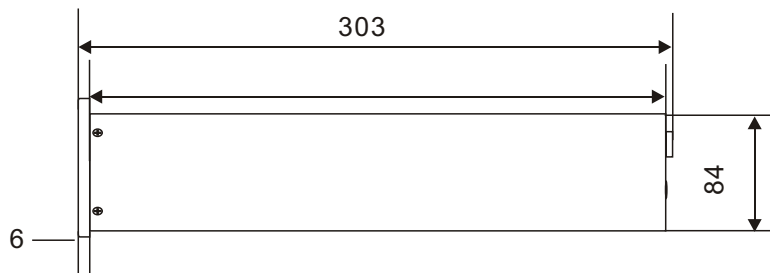
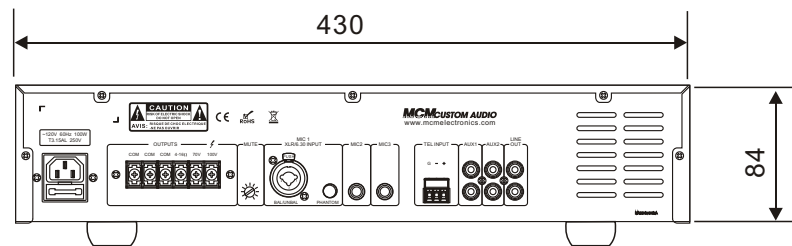
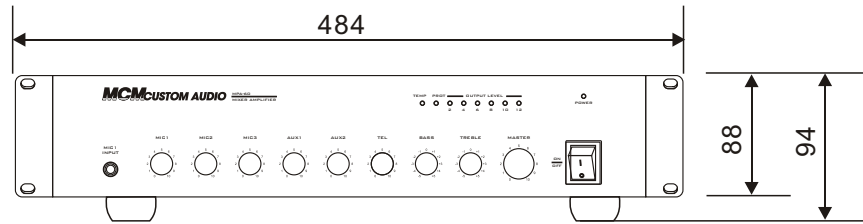

Keep the unit's all sides over 10 cm away from objects that may obstruct air flow to prevent the unit's internal temperature rise.

UNIT:mm

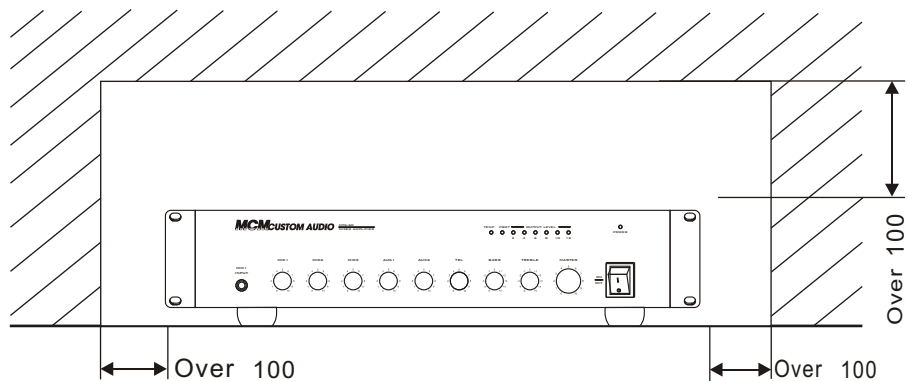

# PUBLIC ADDRESS SYSTEM

MCM Custom Audio and Stellar Labs products are warranted, by MCM Electronics, against manufacturer defects for a period of one year from the original date of purchase. This warranty is limited to manufacturer defects, in either materials or workmanship. MCM Electronics, or any other worldwide divisions of Premier Farnell PLC, are not responsible for any consequential or inconsequential damage to any other component, structure or the cost of installation or removal of said items.

For questions or specific information regarding warranty replacement or repair, please contact:

**MCM**CUSTOM AUDIO  
[www.mcmelectronics.com](http://www.mcmelectronics.com)

800-543-4330

Version V0.1