

50 Ω nominal input / conjugate match balun to ST S2-LP,
868-927 MHz with integrated harmonic filter

Datasheet - production data

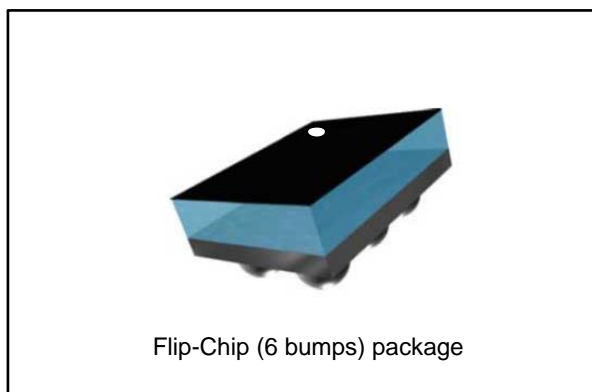

Description

This device is an ultra-miniature balun. The BALF-SPI2-01D3 integrates matching network and harmonics filter. Matching impedance has been customized for the ST S2-LP transceiver.

The BALF-SPI2-01D3 uses STMicroelectronics IPD technology on non-conductive glass substrate which optimizes RF performance.

Figure 1: Bump layout (top view)

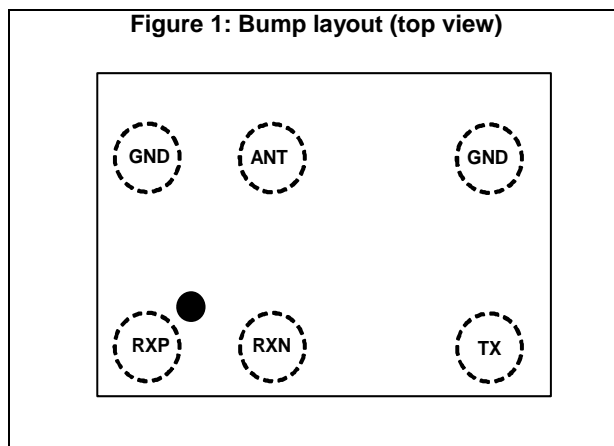

Features

- 50 Ω nominal input / conjugate match to ST S2-LP for 868 - 927 MHz frequency operation
- Low insertion loss
- Low amplitude imbalance
- Low phase imbalance
- Small footprint
- ECOPACK[®]2 compliant component

Benefits

- Very low profile < 620 μm after reflow
- High RF performance
- RF BOM and area reduction

Applications

- 868 - 927 MHz impedance matched balun filter
- Optimized for ST S2-LP sub GHz RFIC

1 Characteristics

Table 1: Absolute ratings (T_{amb} = 25° C)

Symbol	Parameter	Value	Unit
P _{IN}	Input power RF _{IN}	20	dBm
V _{ESD}	ESD ratings human body model (JESD22-A114-C), all I/O one at a time while others connected to GND	2000	V
	ESD ratings machine model, all I/O	200	
T _{OP}	Operating temperature	-40 to +105	°C

Table 2: Impedances (T_{amb} = 25° C)

Symbol	Parameter	Value			Unit
		Min.	Typ.	Max.	
Z _{RX}	Nominal differential RX balun impedance	-	matched ST S2-LP	-	Ω
Z _{TX}	Nominal TX filter impedance				
Z _{ANT}	Antenna impedance	-	50	-	Ω

Table 3: Electrical characteristics and RF performance (T_{amb} = 25° C)

Symbol	Parameter	Value			Unit
		Min.	Typ.	Max.	
f	Frequency range (bandwidth)	868		927	MHz
I _{L_RX-ANT}	Insertion loss in bandwidth without mismatch loss (RX balun)		1.7	2.0	dB
I _{L_TX-ANT}	Insertion loss in bandwidth without mismatch loss (TX filter)		1.7	2.1	dB
R _{L_RX-ANT}	Input return loss in bandwidth (RX balun)	10	14		dB
R _{L_TX-ANT}	Input return loss in bandwidth (TX filter)	15	20		dB
φ _{imb}	Output phase imbalance (RX balun) – absolute value	5	7	9	°
A _{imb}	Output amplitude imbalance (RX balun) – absolute value	1.4	1.6	1.8	dB
Att	Harmonic levels (TX filter)	Attenuation at 2f ₀	40	45	dB
		Attenuation at 3f ₀	47	51	
		Attenuation at 4f ₀	60	65	
		Attenuation at 5f ₀	66	72	
		Attenuation at 6f ₀	50	57	
		Attenuation at 7f ₀	46	50	

1.1 RF measurements (RX balun)

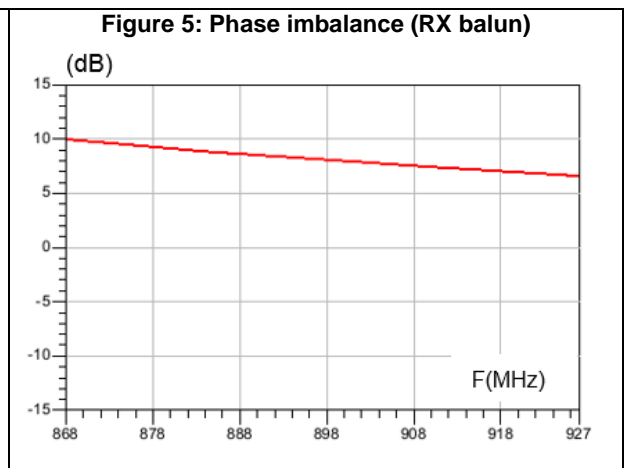
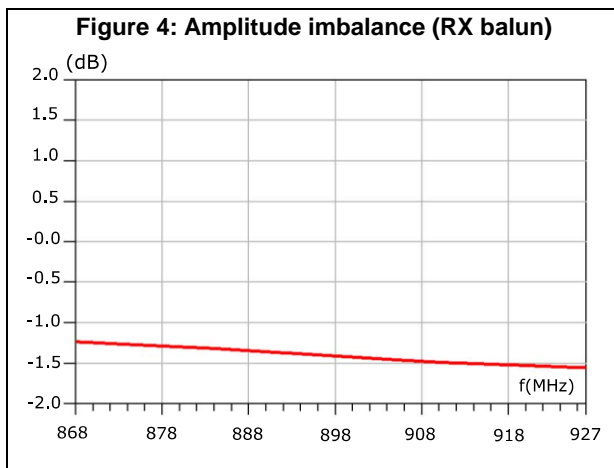
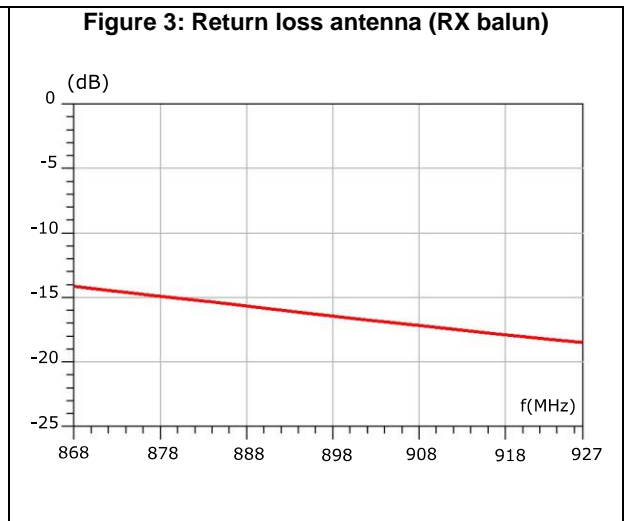
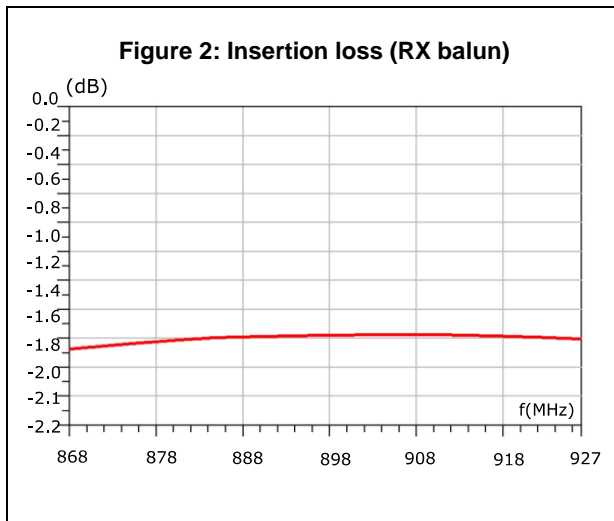

1.2 RF measurements (TX filter)

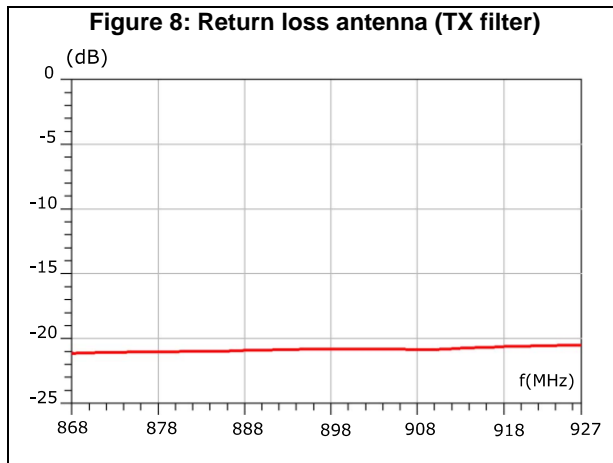
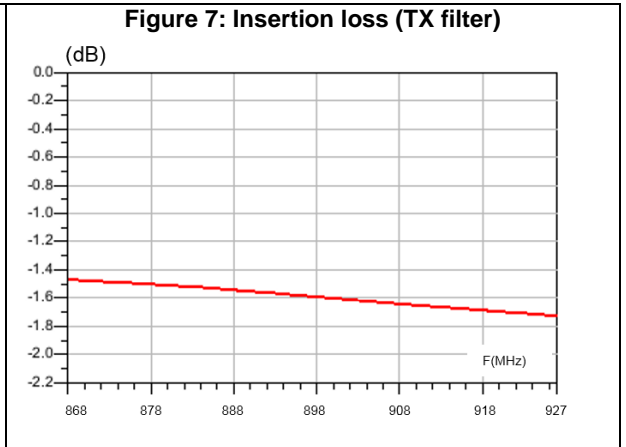
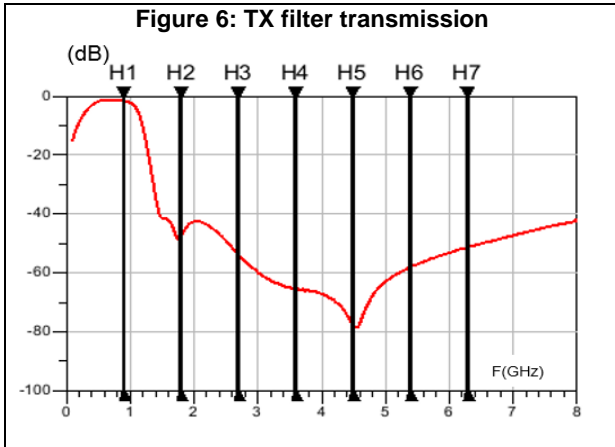

1.3 ST S2-LP evaluation board with BALF-SPI2-01D3

Figure 9: Evaluation board with BALF-SPI2-01D3

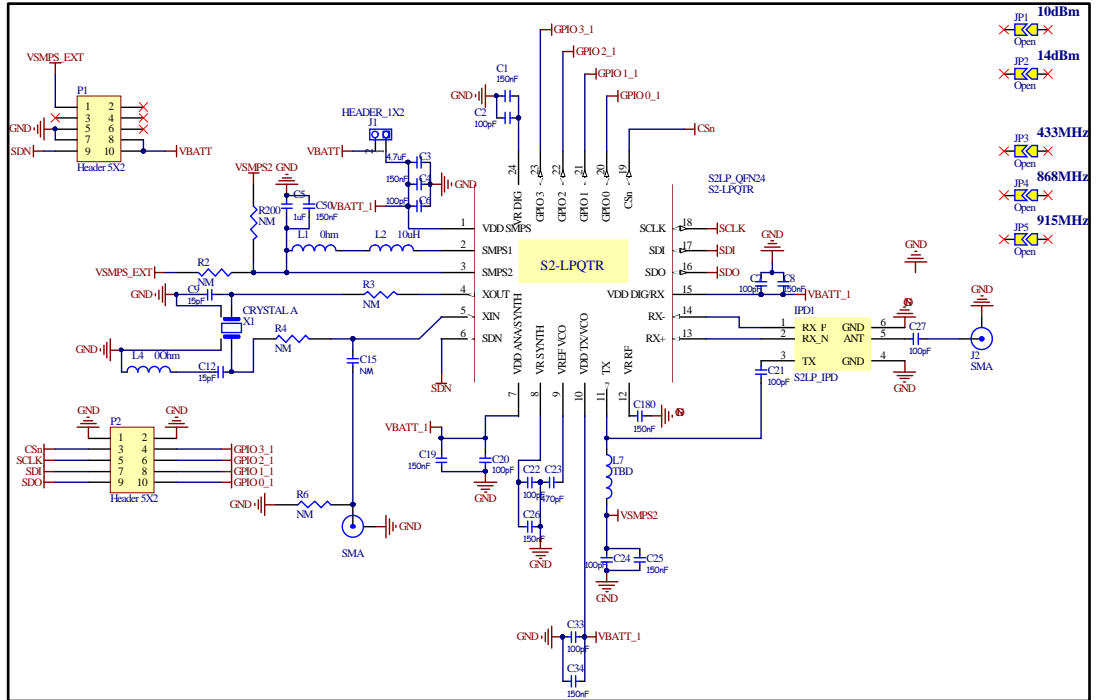

2 Package information

In order to meet environmental requirements, ST offers these devices in different grades of ECOPACK® packages, depending on their level of environmental compliance. ECOPACK® specifications, grade definitions and product status are available at: www.st.com. ECOPACK® is an ST trademark.

2.1 Flip-Chip 6 bumps package information

Figure 10: Flip-Chip 6 bumps package outline (top and side view)

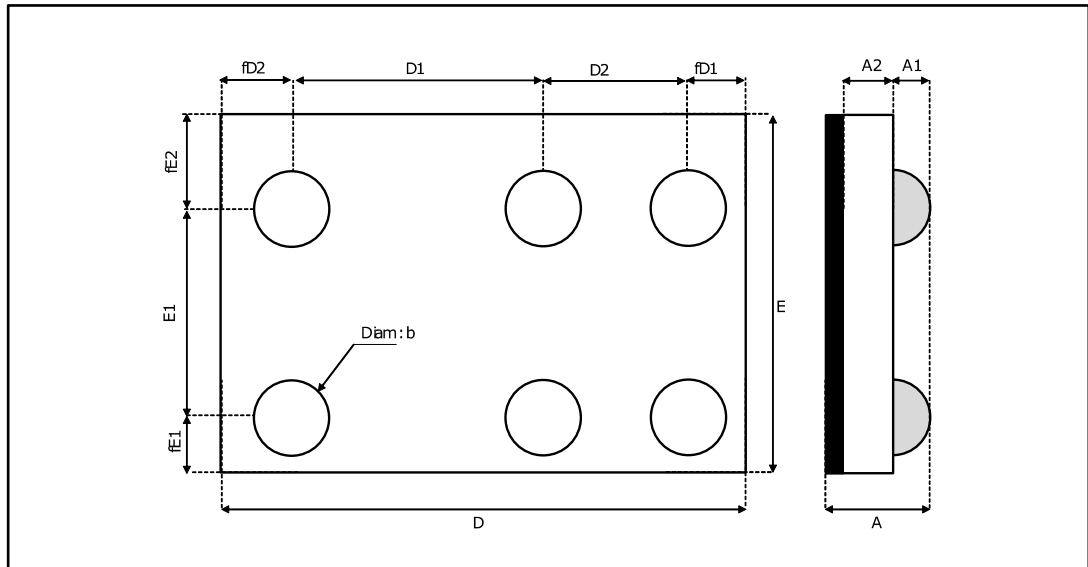

Table 4: Flip-Chip 6 bumps dimensions

Ref.	Dimensions (millimeters)		
	Min.	Typ.	Max.
A	0.580	0.630	0.680
A1	0.180	0.205	0.230
A2	0.380	0.400	0.420
b	0.230	0.255	0.280
D	2.050	2.100	2.150
D1		1.210	
D2		0.500	
E	1.500	1.550	1.600
E1		1.060	
fD1		0.195	
fD2		0.195	
fE1		0.195	
fE2		0.295	

2.2 Flip-chip 6 bumps packing information

Figure 11: Marking

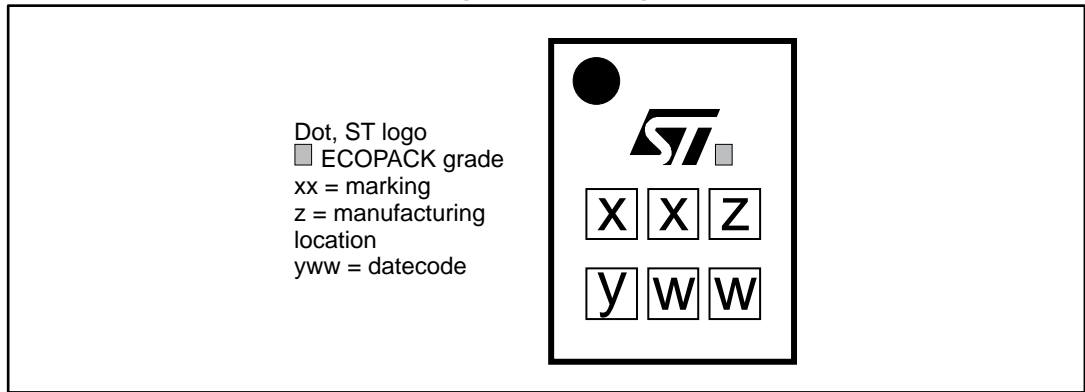
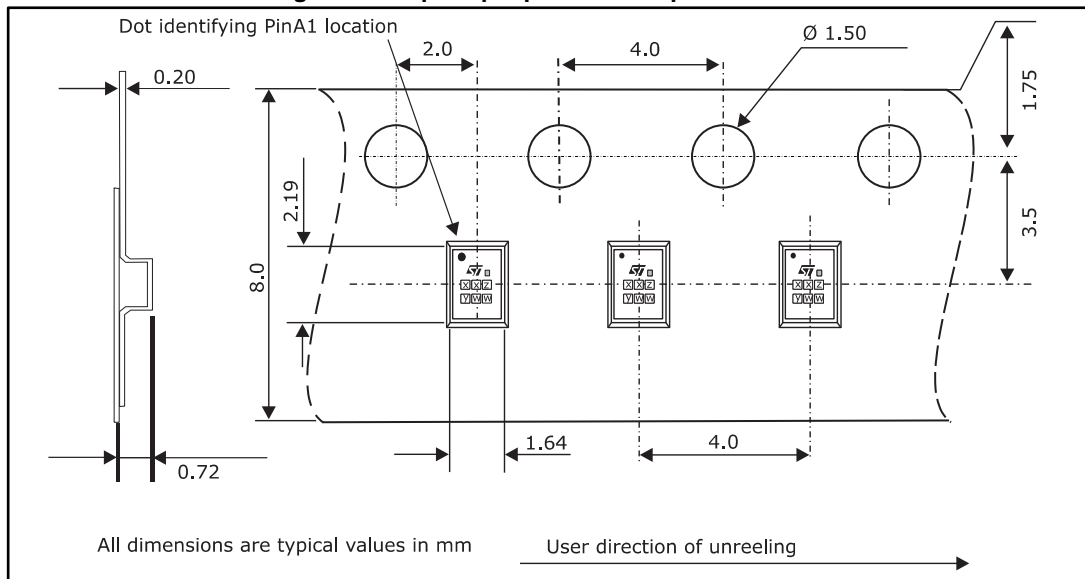

Figure 12: Flip Chip tape and reel specifications



More packing information is available in the application note:

- AN2348 Flip-Chip: "Package description and recommendations for use"

3 Recommendation on PCB assembly

3.1 Land pattern

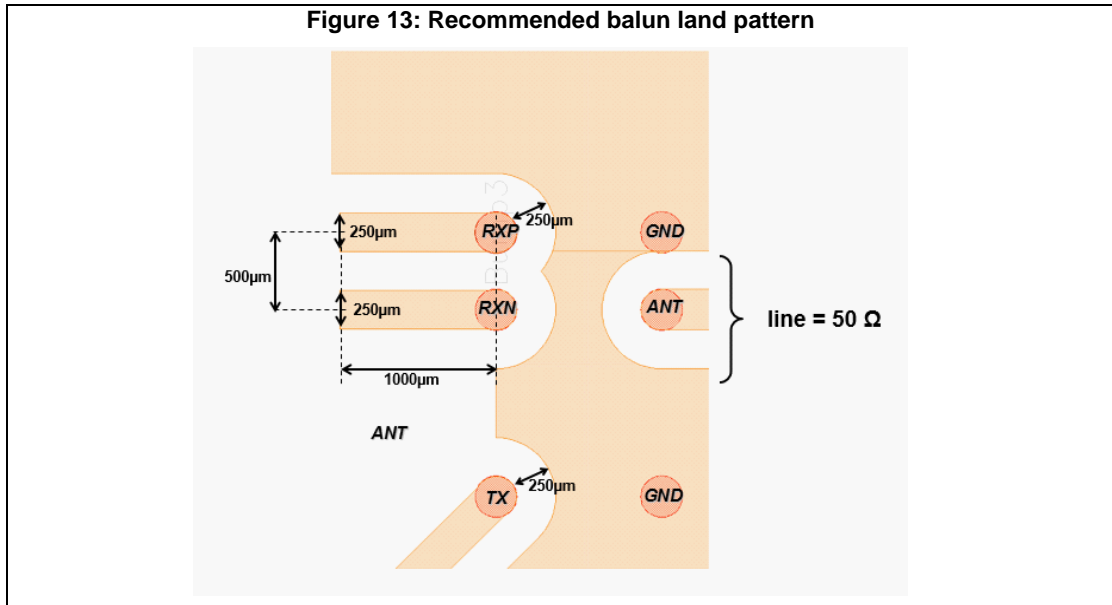

3.2 Stencil opening design

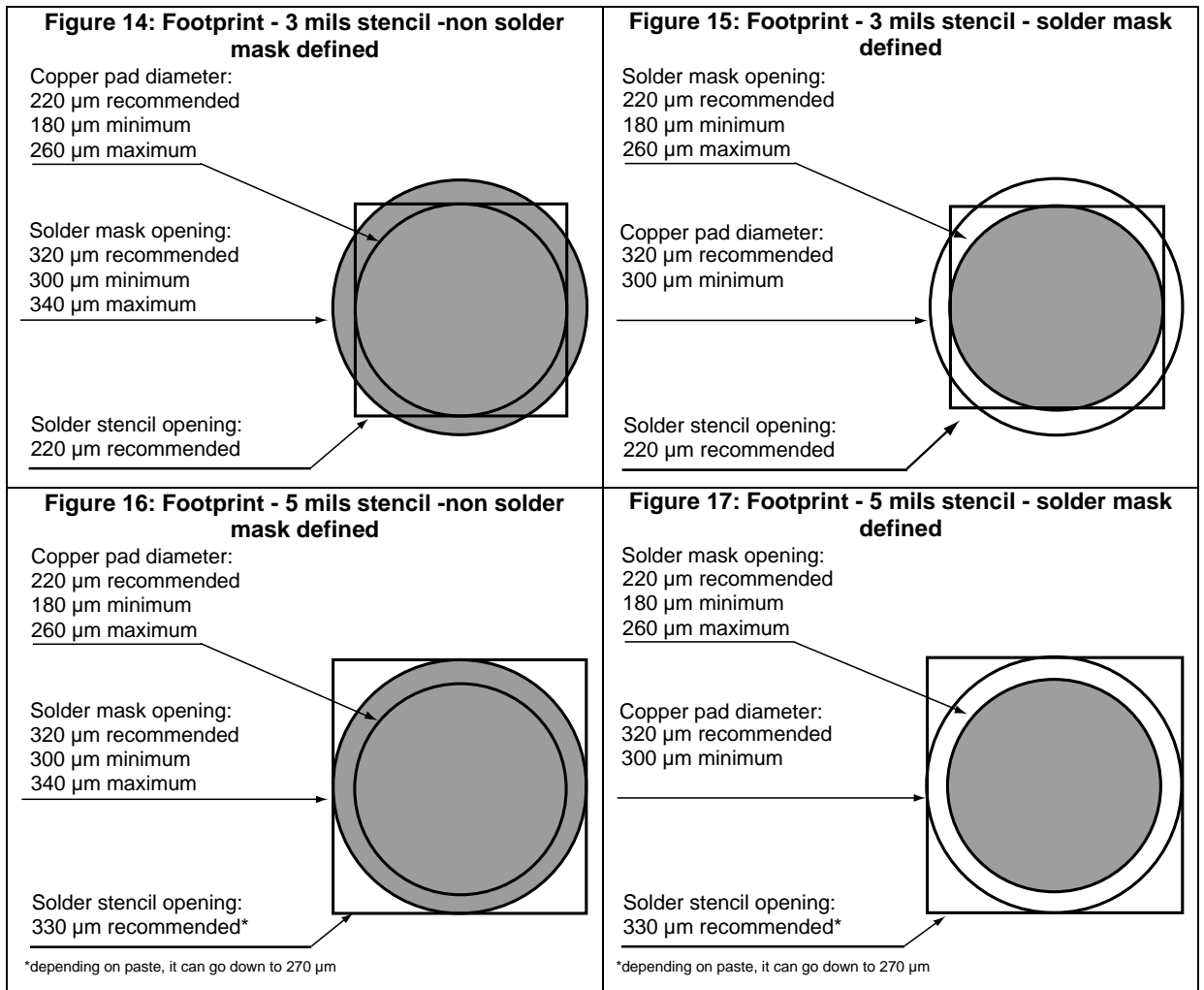

3.3 Solder paste

1. Halide-free flux qualification ROL0 according to ANSI/J-STD-004.
2. "No clean" solder paste is recommended.
3. Offers a high tack force to resist component movement during high speed.
4. Use solder paste with fine particles: powder particle size 20-38 µm.

3.4 Placement

1. Manual positioning is not recommended.
2. It is recommended to use the lead recognition capabilities of the placement system, not the outline centering
3. Standard tolerance of ± 0.05 mm is recommended.
4. 1.0 N placement force is recommended. Too much placement force can lead to squeezed out solder paste and cause solder joints to short. Too low placement force can lead to insufficient contact between package and solder paste that could cause open solder joints or badly centered packages.
5. To improve the package placement accuracy, a bottom side optical control should be performed with a high resolution tool.
6. For assembly, a perfect supporting of the PCB (all the more on flexible PCB) is recommended during solder paste printing, pick and place and reflow soldering by using optimized tools.

3.5 PCB design preference

1. To control the solder paste amount, the closed via is recommended instead of open vias.
2. The position of tracks and open vias in the solder area should be well balanced. A symmetrical layout is recommended, to avoid any tilt phenomena caused by asymmetrical solder paste due to solder flow away.

3.6 Reflow profile

Figure 18: ST ECOPACK® recommended soldering reflow profile for PCB mounting

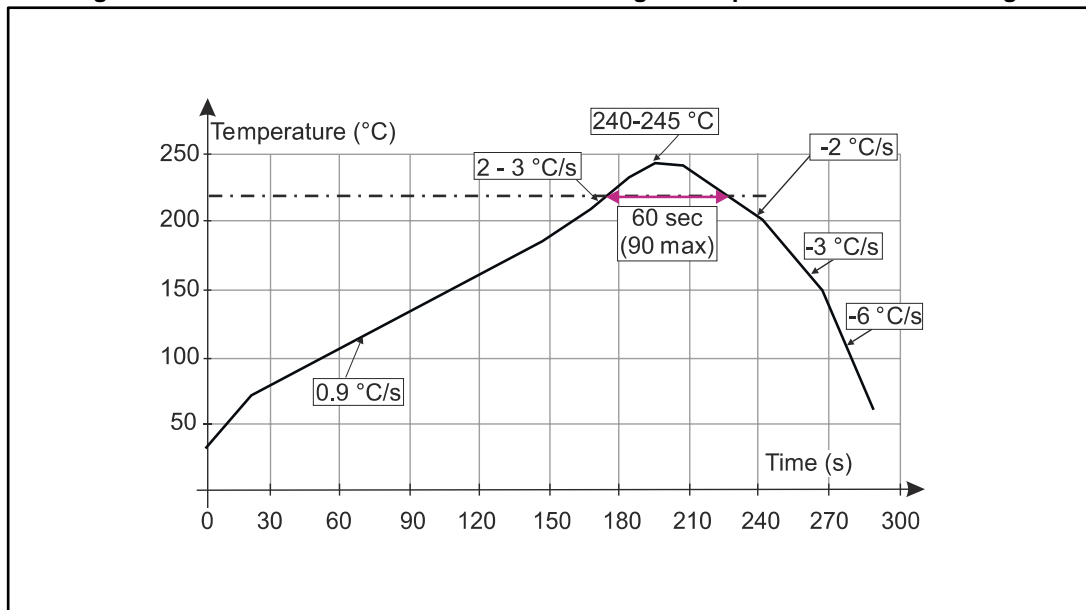

Minimize air convection currents in the reflow oven to avoid component movement.

4 Ordering information

Table 5: Ordering information

Order code	Marking	Package	Weight	Base qty.	Delivery mode
BALF-SPI2-01D3	TM	Flip-Chip 6 bumps	3.4 mg	5000	Tape and reel

5 Revision history

Table 6: Document revision history

Date	Revision	Changes
08-Aug-2017	1	Initial release.

IMPORTANT NOTICE – PLEASE READ CAREFULLY

STMicroelectronics NV and its subsidiaries ("ST") reserve the right to make changes, corrections, enhancements, modifications, and improvements to ST products and/or to this document at any time without notice. Purchasers should obtain the latest relevant information on ST products before placing orders. ST products are sold pursuant to ST's terms and conditions of sale in place at the time of order acknowledgement.

Purchasers are solely responsible for the choice, selection, and use of ST products and ST assumes no liability for application assistance or the design of Purchasers' products.

No license, express or implied, to any intellectual property right is granted by ST herein.

Resale of ST products with provisions different from the information set forth herein shall void any warranty granted by ST for such product.

ST and the ST logo are trademarks of ST. All other product or service names are the property of their respective owners.

Information in this document supersedes and replaces information previously supplied in any prior versions of this document.

© 2017 STMicroelectronics – All rights reserved