



Overview

Digital Bench-Type Multimeter Model 72-8715 is the maximum reading 1999 and 3 1/2 digits, models in manual range, DC / AC current type digital multimeter. This is also the extra large characters in LCD display backlight with full function, full measurement and full overload protection as well as a good product design outlook. In addition to all the conventional features include DC/AC voltage, DC/AC current, resistance, frequency, capacitance, temperature °C, Transistor hFE, diode and continuity buzzer.

This operating manual covers information on safety and cautions. Please read the relevant information carefully and observe all the Warnings and Notes strictly.

Unpacking Inspection

Open the package case and take out the Meter. Check the following items carefully to see any missing or damaged part. If you find any missing or damage, please contact your dealer in your country.

- Operating Manual ----- 1 piece
- Test Lead ----- 1 pair
- Alligator Clip ----- 1 pair
- K Type Temperature Probe (For the temperature under 230°C testing) ----- 1 piece
- Multi-Purpose Socket ----- 1 piece
- Power Code (AC220V 50Hz DC9V/200mA) ----- 1 piece

Safety Information

This Meter complies with the standards IEC61010-1 in pollution degree 2, overvoltage category (CAT II 1000V) and double insulation. If you can not follow up this operating instruction to use the meter and it reduces the chance to have an using protection.

1. Before using the Meter and Test Leads inspect both items. Do not use the Meter and Test Leads if it is damaged or the case (or part of the case) is removed or no reaction on LCD display. Prohibited to use the meter without housing or housing without screw fix up in order to avoid possible electric shock or to avoid possible damage to the meter or to the equipment under test.
2. If the damage of test leads, use only the same model number or identical electrical specifications replacement parts.
3. Do not use your finger to touch on any testing cable, connector, unused terminal input or circuit during the testing stage
4. When the meter working at an effective voltage over 60V in DC or 30V rms in AC, special care should be taken for there is danger of electric shock.
5. Selecting the correct terminal input and turn the rotary switch to select the measuring function. In case of no any idea on the value input of the current, just simply test from the high value to low one.
6. Do not overload voltage or current on EITHER between terminal and terminal OR between terminal and grounding which indicate on meter limitation.
7. The rotary switch should be placed in the right position and no any changeover of range shall be made during measurement is conducted to prevent damage of the Meter.







72-8715 Operating Manual

8. Do not use or store the meter in an environment of high temperature, humidity, flammable and electromagnetic environment. The performance of the meter may deteriorate after dampened.
9. The internal circuit of the meter shall not be altered at will to avoid damage of the meter and any accident
10. Replace the battery as soon as the battery indicator "🔋" Appears. With a low battery, the meter might produce false readings that can lead to electric shock and personal injury.
11. Turn the meter off when it is not is use and take out the battery when not using for a long time.

General Specifications









1. Maximum Voltage between terminal input and COM: 1000V (except 200mV, 230V)
2. μ A mA terminal input protection: (CE) 250mA 265V auto recovery fuse
3. 10A terminal input protection : (CE) F1 (10A H 250V) Fast type melted fuse Φ 5x20mm
4. Resistance input protection : PTC/250V
5. Capacitance input protection : (CE) F2,F3 (0.5A H 250V) Fast type melted fuse Φ 5x20mm
6. Frequency input protection : PTC/250V
7. Temperature input protection : (CE) 250mA 265V fuse
8. \rightarrow \bullet) terminal input protection : PTC/250V
9. hFE input protection: (CE) 250mA 265V auto recovery fuse, F3 (0.5A H 250V) Fast type melted fuse Φ 5x20mm
10. Display LCD full function signal display, maximum reading is 1999 (72-8715),
Updates 2-3 times / second
11. Range Manual
12. Polarity Display: Auto
13. Overload indication: 1
14. Battery Deficiency 🔋
15. Operating Temperature: 0 to 40°C
16. Storing Temperature: -10 to 50°C
17. Relative Humidity: 0°C to 30°C below \leq 75%, 30°C to 40°C \leq 50%
18. Electromagnetic Field: Under 1V/m the influence of radiated radio-frequency electromagnetic field phenomenon. Total accuracy= specific accuracy+ measurement 5%, Over 1V/m radiated radio-frequency electromagnetic which do not have any reference data on this topic.
19. Power AC (external power adapter AC220V/DC9V-200mA) or DC(internal battery type 2 R14/1.5V 6 pieces)
20. Product size : (300 x 245 x 105) mm
21. Product Net Weight : About1500g (without the accessories)
22. Safety Compliances IEC 61010: CAT II 1000V

LCD Display

1. ----- Manual Range ----- Indicator of manual range
2. ----- Warning ! ----- Indicator for Warning signal
3. -----  ----- The battery is low
4. -----  ----- Indicator for high voltage signal
5. -----  ----- Indicator for Negative reading display
6. ----- AC ----- Indicator for AC voltage or current(DC indicator do not display)
7. -----  ----- Data hold is active
8. -----  ----- Test of diode
9. -----  ----- The continuity buzzer is on
10. -----  ----- Indicates testing reading
11. Units of measurement:

mV,V	Unit of Voltage: The millivolt, volt
μA,mA,A	Unit of current: Microampere, milliampere, ampere
Ω,kΩ,MΩ	Unit of electrical resistance: Ohm, thousand ohms, trillion ohm
nF,μF	Unit of electrical capacity: Accepts the farad, the microfarad
kHz	Unit of Frequency: KiloHertz
°C	Unit of Temperature: Degree Celsius
β	Factor Unit of Triode enlargement: Times

1.Functions

Symbol	Terminal Input	Explanation
	V ↔ COM	DC Voltage Measurement
	V ↔ COM	AC Voltage Measurement
	V ↔ COM	Resistance Measurement
	V ↔ COM	Diode / Continuity Buzzer Measurement
kHz	V ↔ COM	Frequency Measurement
	mA μA ↔ COM	mA/μA DC Current Measurement
	10A ↔ COM	A DC Current Measurement
	mA μA ↔ COM	mA/μA AC Current Measurement
	10A ↔ COM	A AC Current Measurement
F	V ↔ mA μA(Use Multi-Purpose Socket)	Capacitance Measurement
°C	V ↔ mA μA(Use Multi-Purpose Socket)	Temperature Measurement
hFE	V ↔ mA μA(Use Multi-Purpose Socket)	Triode Enlargement Factor Measurement

72-8715 Operating Manual

2. Functional Buttons

⏻ Turn the power on and off

LIGHT Turn the display backlight on and off (suitable for battery supply, backlight turn on about 10 seconds after auto shut down.)

HOLD Press Hold to enter and exit the hold mode in any mode, the meter beeps

Operational Measurement Guide (see Diagram 1, 2, 3)

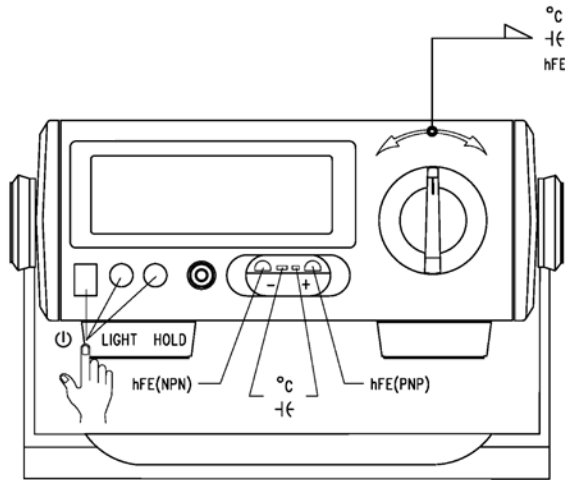

Diagram 1

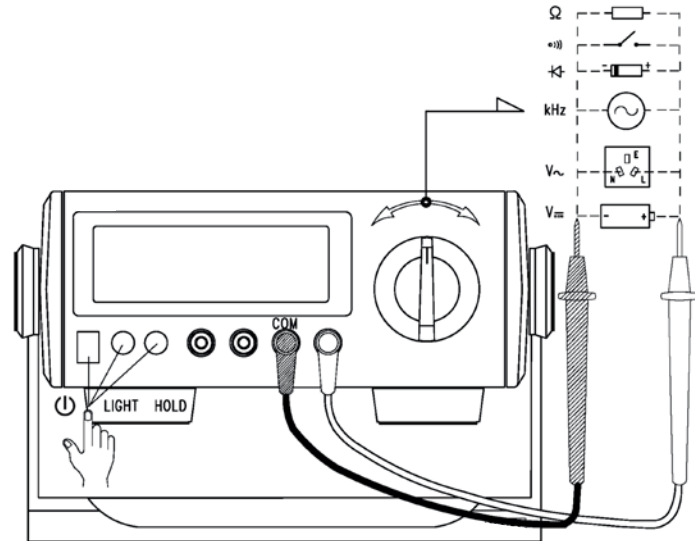
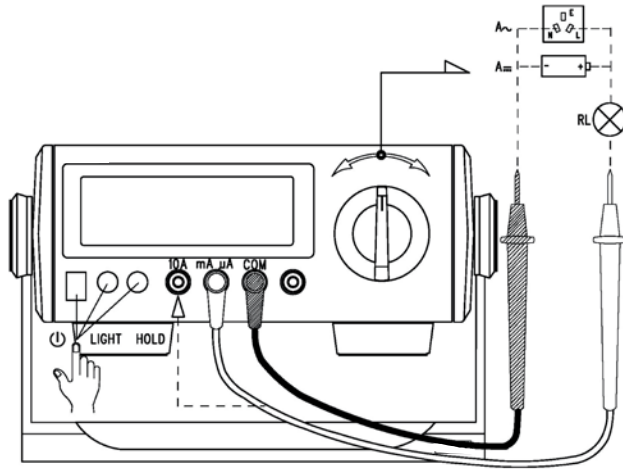

Diagram 2



⚠ Warning:

1. Selecting the correct terminal input and turns the rotary switch to select the measuring function. If fails to do that, the buzzer beep and the warning signal flash on!

Range	Alarm Alert On False Terminal Input
V Hz Ω →+•))	10A mAμA
mAμA °C hFE F	10A
10A	mAμA

72-8715 Operating Manual

2. DC or AC Voltage Measurement

- To avoid harms to you or damages to the Meter from electric shock, please do not attempt to measure voltages higher than 1000 V although reading may be obtained!
- The Meter has an input impedance of 10M Ω . This loading effect can cause measurement errors in high impedance circuits and so you need to take a note on it.

3. DC or AC Current Measurement

- Before connect the Meter in serial with the tested return circuit, closed the return circuit current to avoid the dangerous of sparking.
- Do not use over >10A current measurement ! Although the meter can work on below 20A current testing but for the avoiding any harms to you or damages to the Meter !

4. Measuring Resistance, Diodes, Continuity or Capacitance

- To maintain the measurement accuracy, discount circuit power and discharge all the high voltage capacitors during the measuring resistance.
- When measuring high resistance on 1M Ω or above, it is normal to take several seconds to obtain a stable reading. In order to obtain stable reading, choose shorter test lead to carrying out measurement.
- The test leads and the Meter inside wire will bring around 0.1 Ω to 0.2 Ω of error to resistance measurement when measuring low resistance. To obtain accurate readings in low-resistance, short –circuit the test leads beforehand and record the reading obtained, call this reading as X. Then use the equation: measured resistance value (Y) – (X) = accurate readings of resistance.
- During \rightarrow (•) measurement. Diodes is in a good silicon junction drops between 500mV to 800mV as the normal value; The continuity measurement, the poles between resistance is >100 Ω , it is a short circuit, but on the poles between resistance is \leq 10 Ω , it is a good connection, buzzer is continually beep on, and the reading value is nearly to the circuit resistance value, Unit is Ω .

Accuracy Specifications

Accuracy: \pm (% reading + digits), guarantee for 1 year

Operating temperature: 18 to 28 $^{\circ}$ C

Environmental humidity: Less than 75%RH

1. DC Voltage

Range	Resolution	Accuracy Tolerance: \pm (% Reading + Digits)
	72-8715	72-8715
200mV	0.1mV	\pm (0.5%+2)
2V	1mV	
20V	10mV	
200V	100mV	
1000V	1V	\pm (0.8%+3)

Input Impedance : is average on 10M Ω

Maximum Voltage Input: 1000V (Except 200mV, 250V)

2. AC Voltage

Range	Resolution	Accuracy Tolerance: \pm (% Reading + Digits)
	72-8715	72-8715
2V	1mV	\pm (0.8%+3)
20V	10mV	
200V	100mV	
750V	1V	\pm (1.0%+4)

Input Impedance: (72-8715) is average on 10M Ω .

Maximum Voltage Input: 750Vrms

Frequency: 45Hz to 400Hz

Display: True RMS

3. DC Current

Range	Resolution	Accuracy Tolerance: \pm (% Reading + Digits)
	72-8715	72-8715
200 μ A	0.1 μ A	\pm (0.8%+2)
2mA	1 μ A	
20mA	10 μ A	
200mA	0.1mA	
10A	10mA	\pm (2.0%+4)

72-8715 Operating Manual

* When $\geq 5A$, Continuous measurement less than 10 seconds at an interval more than 15 minutes.

4, AC Current

Range	Resolution	Accuracy Tolerance: $\pm(\% \text{ Reading} + \text{Digits})$
	72-8715	72-8715
2mA	1 μ A	$\pm (1.0\%+3)$
20mA	10 μ A	
200mA	0.1mA	
10A	10mA	$\pm (2.5\%+5)$

Frequency: 45Hz to 400Hz

* When $\geq 5A$, Continuous measurement less than 10 seconds at an interval more than 15 minutes.

5, Resistance

Range	Resolution	Accuracy Tolerance: $\pm(\% \text{ Reading} + \text{Digits})$
	72-8715	72-8715
200 Ω	0.1 Ω	$\pm (0.8\%+3)$
2k Ω	1 Ω	
20k Ω	10 Ω	
200k Ω	100 Ω	
2M Ω	1k Ω	
20M Ω	10k Ω	$\pm (1.2\%+5)$
200M Ω		

6. Capacitance

Range	Resolution	Accuracy Tolerance: $\pm(\% \text{ Reading} + \text{Digits})$
	72-8715	72-8715
20nF	10pF	$\pm(4\%+3)$
2 μ F	1nF	
200 μ F*	100nF	$\pm(5\%+5)$

*: $> 40\mu$ F capacitance measurement as reference purpose.

7. Frequency

Range	Resolution	Accuracy Tolerance: $\pm(\% \text{ Reading} + \text{Digits})$
	72-8715	72-8715
2kHz	1Hz	$\pm(1.5\%+5)$
200kHz	100Hz	

Input Amplitude: (2kHz range) $50\text{mV} \leq a \leq 30\text{Vrms}$, (200kHz range) $150\text{mV} \leq a \leq 30\text{Vrms}$

8. Temperature

Range	Resolution	Accuracy Tolerance: $\pm(\% \text{ Reading} + \text{Digits})$
	72-8715	72-8715
-40 to -20°C	1°C	-(8%+5)
>-20 to 0°C		$\pm(1.2\%+4)$
>0 to 100°C		$\pm(1.2\%+3)$
>100 to 1000°C		$\pm(2.5\%+2)$

* Thermocouple: It is suitable to use K type thermocouple. This include point contact K type thermocouple can only be used on less than 230°C temperature measurement.

9. Diode Test

Range	Resolution	Remarks
	72-8715	
→+	1mV	Open circuit voltage is around 3 V, Silicon junction drops between 0.5 to 0.8V as the normal value.

10. Continuity Test

Range	Resolution	Remarks
	72-8715	
•)	1Ω*	Open circuit voltage is approximate 3V; When circuit disconnected with resistance value : > 100Ω, buzzer does not beep; When circuit is in good connection with resistance value : ≤10Ω, buzzer beeps continuously.

72-8715 Operating Manual

11. Transistor hFE

Range	Resolution	Remarks
	72-8715	
hFE	1 β *	I _{b0} is about 10 μ A; V _{ce} is about 2.5V

see Diagram 4

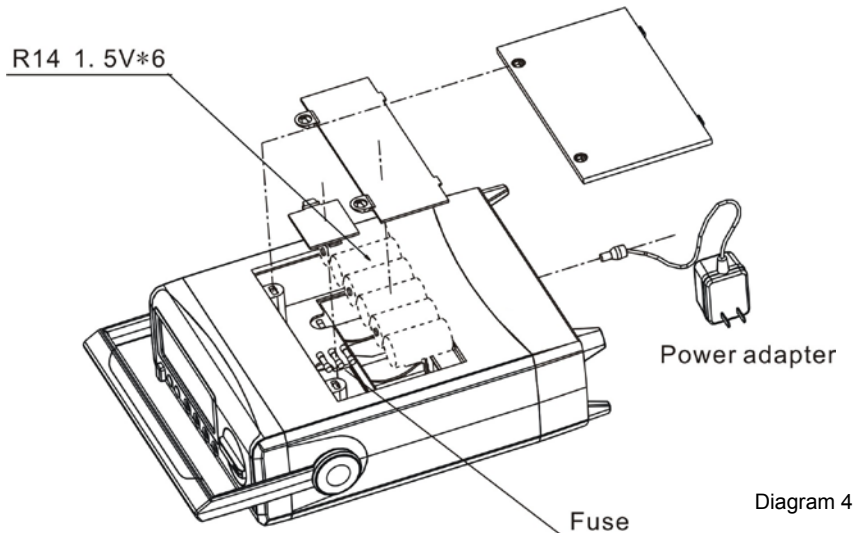

Specifications and other information shown on this instruction manual are subject to change without notice

Copyright 2010 Tenma. All rights reserved.

Manufacturer:

Tenma

405 S. Pioneer Blvd,
Springboro, Ohio 45066-3001

Phone: 1-888-655-5409

Fax: 1-800-765-6960

REV.1

DATE:2015-12-15

P/N:110401105612X

说明书菲林做货要求:

序号	项目	内容
1	尺寸	尺寸: 210X145mm
2	材质	80g书纸
3	颜色	单黑印刷
4	外观要求	印字完整清晰、版面整洁, 无斑墨、残缺破损、毛边、装订不齐等缺陷。
5	装订方式	两枚大钉钉装
6	表面处理	无
7	修改	版本.1 韦英锁2015/12/15 1.修改前物料号: 110401101889X 2.修改第7页的AC Voltage 参数 3.最后一页增加PN号
8	REV.	2

DWH 设计		MODEL	Part NO.
CHK 审核		机型: 72-8715 (UT801改)	物料编号: 110401105612X
APPRO. 批准		 优利德科技(中国)有限公司 UNI-TREND TECHNOLOGY (CHINA) LIMITED	