

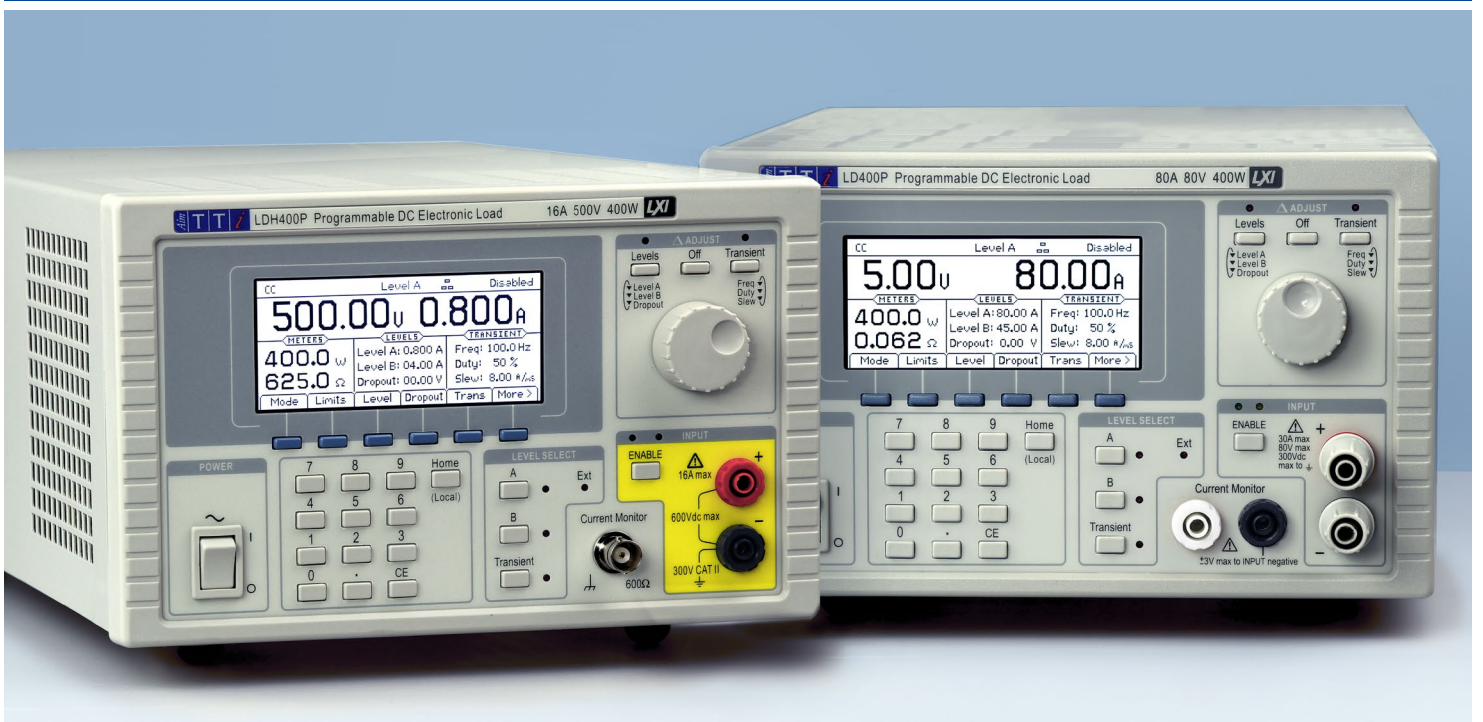

LD SERIES Electronic DC Loads



80A-80V-400W or 16A-500V-400W

Constant current, resistance, power, voltage and conductance

Transient generator, variable slew rate, soft start

Current monitor output, analog remote control

USB, RS-232, GPIB and LAN interfaces

aimtti.com | aimtti.us

LD SERIES Key Features

COMPACT ELECTRONIC DC LOADS

The LD series features electronic loads which are suitable for testing and characterising a wide variety of dc power sources. They can be used to investigate the behavior of many different types of power source such as PFCs, batteries and solar cells, as well as electronic power supply units. The wide voltage/current range, multiple operating modes and built-in transient generator give them versatility to offer test solutions from the design laboratory through to the component test area.



FEATURES SUMMARY

- ▶ Variable drop-out voltage for battery testing
- ▶ 400 watts continuous dissipation at 28°C (de-rating to 360W at 40°C)
- ▶ Constant current, resistance, conductance, voltage (LD400 models only) and power modes
- ▶ High resolution and accuracy for level setting
- ▶ Current monitor output for waveform viewing
- ▶ Front and rear input terminals
- ▶ Built-in transient generator with variable slew
- ▶ High resolution backlit graphic LCD with soft key control
- ▶ Analog remote control of levels and TTL control of on/off and transient switching
- ▶ Full bus control via USB, RS232, GPIB and LXI compliant LAN interfaces *

* P models only

MODEL COMPARISON

	LD400 & LD400P	LDH400P
Max Power range	400W (600W short term)	400W
Max Current	80A rear panel 30A front panel	16A
Operating range	0- 80V	10- 500V
Isolation voltage	±300Vdc	CAT II (300V)
Operating modes	CC,CP,CR,CG,CV	CC,CP,CR,CG

PFC TEST EXAMPLE

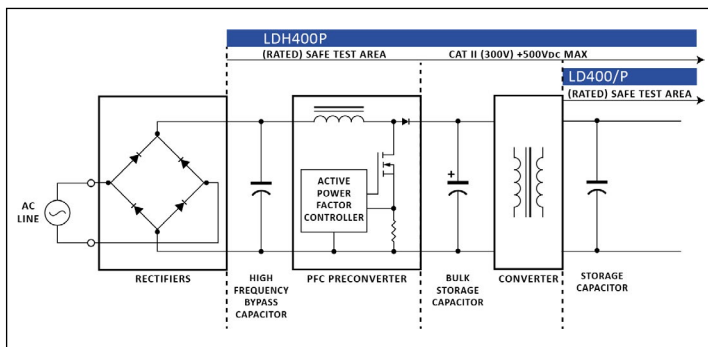

LD400 & LD400P

Low minimum operating voltage of <1V at 40A

Wide voltage and current range 0-80V & 0-80A

600 watts short term dissipation (up to 60 seconds)

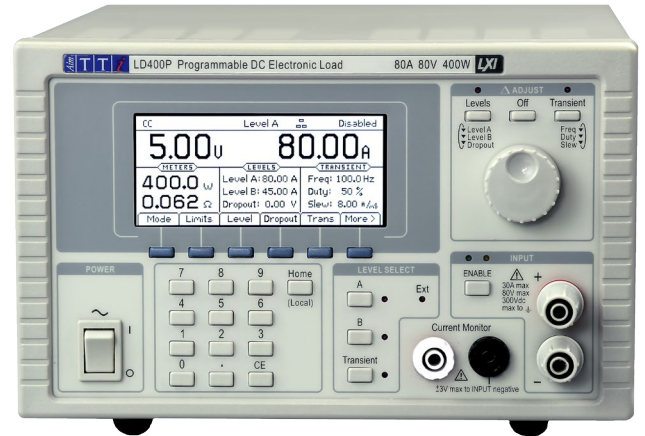

LOW MINIMUM OPERATING VOLTAGE

The LD400 can operate at voltages below 500mV for currents up to 10 amps. At higher currents the fixed minimum resistance (typically better than 25mΩ) gradually raises the minimum operating voltage, but it remains below 1 volt up to 40 amps and below 2 volts up to 80 amps. This low operating voltage allows it to be used for many low voltage applications for which other electronic loads are unsuitable.

600 WATTS INTERMITTENT POWER

The LD400 can operate at power levels up to 600 watts for periods of up to 1 minute. Short term loading can be sufficient for many testing applications and significantly extends the usefulness of the LD400.

LDH400P

Wide voltage and current range 10 to 500V and 0 to 16A

Load inputs rated to CAT II (300V)

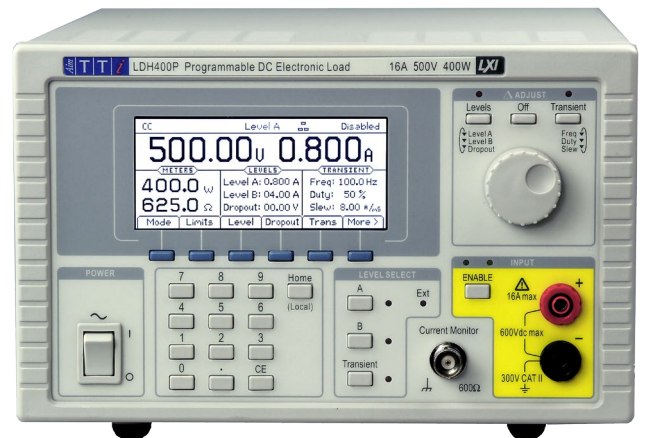

CAT II (300V) RATING

The LDH400P load inputs are rated to CAT II (300V), this allows the direct testing of PFCs and mains connected power supplies to be simplified using the LDH400P by eliminating the need for an isolation transformer, saving bench space and cost.

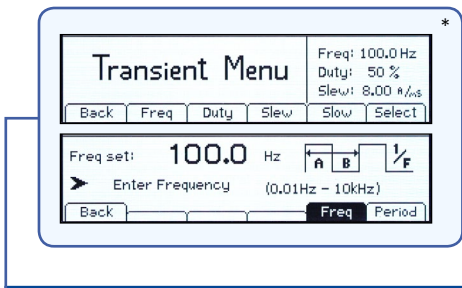

TRANSIENT GENERATOR AND VARIABLE SLEW

The LD series incorporates a full variable frequency, variable duty cycle transient generator.

Switching between the two preset levels can be done at any frequency between 0.01Hz and 10kHz. The transient generator can be used in all operating modes.

The rate of change between levels (slew rate) is controllable over a wide range.

Slew rate control applies to all changes of level including remote control and manual changes between level A and level B.

A slow-start function can be selected for situations where latching would otherwise occur at switch-on.

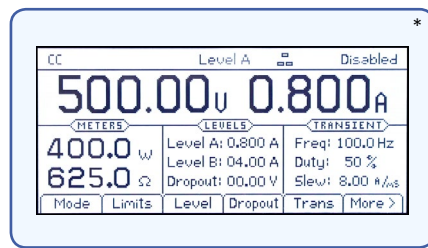

HIGH RESOLUTION SETTING/MEASUREMENT

The two operating levels for each operating mode are settable to high precision.

Levels are displayed using four digit meters which provide resolution down to 1mA, 1mV and 1mW.

The meters have an accuracy of 0.1% for voltage and 0.2% for current.

CURRENT WAVEFORM MONITOR

It is often important to be able to observe the load current waveform on an oscilloscope. The LD series provides a calibrated monitor output for this purpose as well as a sync output from the transient generator.

The LDH400P monitor output is ground (chassis) referenced and isolated from the load input, thus allowing it to be connected to a ground oscilloscope.

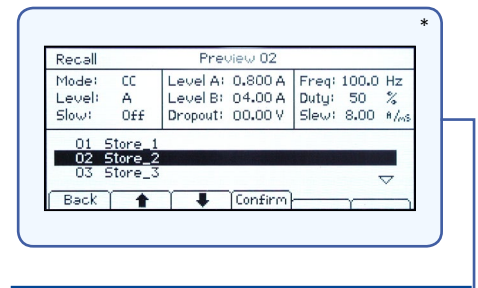

SETTING MEMORIES

Thirty non-volatile memories are provided which store all of the parameters of the load. This makes the LD series highly suitable for repetitive test use.

ADJUSTABLE VOLTAGE DROPOUT

Some power sources, such as rechargeable batteries, can be damaged if their output voltage falls below a certain level. The LD series provides automatic protection by incorporating fully variable voltage dropout. If the voltage applied to the load falls below a preset level, the load current is rapidly reduced to zero.

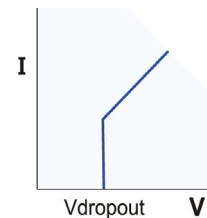

Resistive discharge (conductance mode) with voltage dropout.
Note that in CR mode the load performs the equation $I = (V - V_d) / R$ where V_d is the dropout voltage.

MULTIPLE MODES OF OPERATION

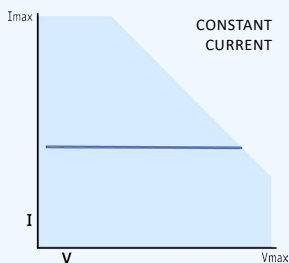

CONSTANT CURRENT MODE

Used for load testing of normal voltage-source power supplies and for constant current discharge testing of batteries.

This mode provides rapid measurement of power source regulation (V/I characteristics).

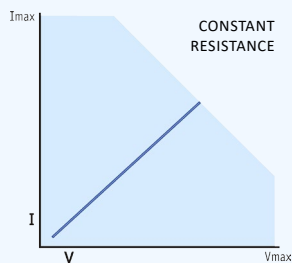

CONSTANT RESISTANCE MODE

Simulates a standard resistive load by providing a current drain proportional to voltage. Settings are displayed in Ohms or milli-Ohms.

Unlike fixed resistors or rheostats, the load provides a precisely controllable resistance with high power dissipation and high temperature stability over a wide value range.

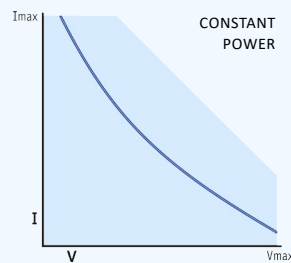

CONSTANT POWER MODE

Simulates a load whose power consumption is independent of the applied voltage.

This is true of many types of equipment that incorporate switch-mode regulators.

This mode may be particularly suitable for testing power sources of portable devices such as Lithium-ion batteries.

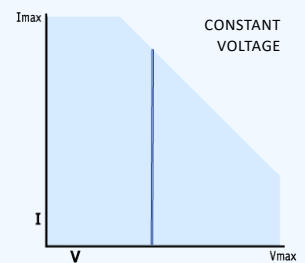

CONSTANT VOLTAGE MODE

(LD400 MODELS ONLY)

Used for load testing of constant current power supplies. The unit operates as a high power shunt regulator.

CONSTANT CONDUCTANCE MODE
As well as showing settings in amps per volt, this mode provides better resolution when setting very low equivalent resistance values.

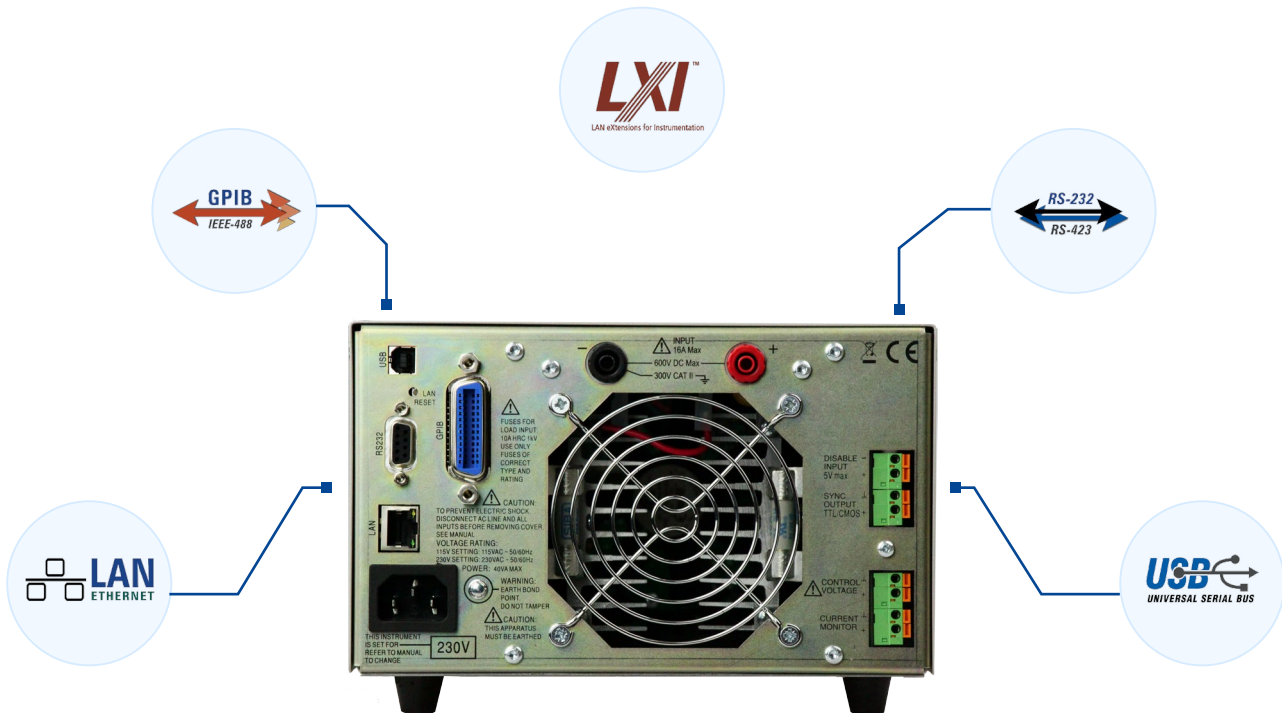

ANALOG REMOTE CONTROL

The LD series incorporates analog remote control for all modes of operation. When “external voltage” is selected the level becomes linearly proportional to the voltage applied to the remote control inputs on the rear panel.

A waveform can be used as the control voltage allowing complex load conditions to be simulated using, for example, an arbitrary waveform generator, such as the Aim-TTi TGF3000 series or a true arbitrary generator from the TGA series.

Alternatively, a logic signal can be used to switch between levels. When “external TTL” is selected, the level is switched between the two defined levels in response to an external logic signal.

LABVIEW & IVI DRIVER

An IVI driver for Windows is included with all P models in the LD series. This provides support for common high-level applications such as LabView*, LabWindows*, and KeysightVEE*.

COMPREHENSIVE BUS REMOTE CONTROL

To meet a wider variety of needs, the P models in the LD series add a comprehensive array of digital bus interfaces. USB, RS-232, GPIB and LAN with LXI support are all provided as standard.

Each of the digital bus interfaces provides full control and read-back of settings and status. The interfaces are at ground potential and are opto-isolated from the terminals.



A standard RS-232/RS-423 interface is provided for use with legacy systems with a baud rate of 9600. The serial interface remains in common usage and is perfectly satisfactory for the control of load devices.



The GPIB interface is compliant with IEEE-488.1 and IEEE-488.2. GPIB remains a widely used interface for system applications. The interface subsets provided are: SH1, AH1, T6, L4, SR1, RL2, PP1, DC1, DT0, C0, E2.



USB provides a simple and convenient means of connection to a PC and is particularly appropriate for small system use. A standard USB 2.0 driver is provided which operates as a virtual COM port and supports Windows 2000 and above including Win 8 and 10.



The LAN interface uses a standard 10/100 base-T Ethernet hardware connection with ICMP and TCP/IP Protocol for connection to a Local Area Network or direct connection to a single PC. This interface supports 1.4 LXI core 2011 and is highly appropriate for system use because of its scalable nature and low cost interconnection.



The LAN interface is LXI compliant. LXI (LAN eXtensions for Instrumentation) is the next-generation, LAN-based modular architecture standard for automated test systems managed by the LXI Consortium, and is expected to become the successor to GPIB in many systems. For more information on LXI go to: www.aimtti.com/go/lxi

MODEL		LD400 & LD400P	LDH400P
MAXIMUM INPUT RATINGS			
Current	Rear panel	80A	16A
	Front panel	30A	
Voltage:		80V	500V
(Max while conducting current)			
Power:	Continuous	400W up to 28°C. 360W at 40°C	400W up to 28°C. 360W at 40°C
	Short term	(1) 600W up to 28°C	
Minimum Operating Voltage:		<2V at 80A	10V
Minimum Effective Resistance:		25mΩ	1Ω
Off State Leakage:		<10mA	<5mA
(Including voltage sense circuit input resistance)			
Reverse Polarity:		80A	16A
(Diode will conduct)			
Isolation Voltage:		±300Vdc	CAT II (300V)
(Either load input to chassis ground)			
Input Terminals: (Safety terminals)	Rear panel input	5mm diameter wire or 8mm spades 80A 4mm plugs at 30A	4mm plugs at 16A
	Front panel input	4mm diameter wire, 6.5mm spades or 4mm plugs at 30A	
EXTERNAL VOLTAGE SENSE (LD400 & LD400P ONLY)			
Connection:		Terminal block on rear panel. Sense selection by slide switch.	
Input Impedance:		680kΩ each input to load negative	
Max. Sense Offset:		6V (allowance for backing-off supply for zero volt operation)	
OPERATING MODES			
CC MODE			
Range:	Low	0-8A	0-16A
	High	0-80A	
Accuracy:		± 0.2% ± 30mA	± 0.2% ± 30mA
Resolution:	Low	1mA	1mA
	High	10mA	
Regulation:		< 30 mA for 90% load power change (Volts > 2V)	< 30 mA for 90% load power change (Volts > 25V)
Temperature Coefficient:		< (±0.02% ± 5 mA) per °C	< (±0.02% ± 5 mA) per °C
(2) Slew Rate Range:	Low	<2.5A per s to >250A per ms	<5A per s to >500A per ms
	High	<25A per s to >2500A per ms	
Minimum Transition Time:		(3) 50µs	(4) 50µs
CP MODE			
Range:		0-400W (or 600W)	0-400W
Accuracy:		± 0.5% ± 2V ± 30 mA	± 0.5% ± 2V ± 30 mA (Volts > 25V)
Resolution:		100mW	100mW
Regulation:		< 2% over 5V to 75V source voltage change (using remote sense)	< 2% over 25V to 550V source voltage change
Temperature Coefficient:		< (± 0.1% ± 5 mA) per °C	< (± 0.1% ± 5 mA) per °C

MODEL		LD400 & LD400P	LDH400P
OPERATING MODES			
CP MODE CONT.			
(2) Slew Rate Range:		< 40W per s to > 6000W per ms	60W per s to 6000W per ms
Minimum Transition Time:		(3) 150µs	(4) 150µs
CR MODE			
Range:	Low	0.04-10Ω	50Ω-10kΩ
	High	2-400Ω	
Accuracy:		±0.5% ± 2 digits ± 30 mA	±0.5% ± 2 digits ± 30 mA (Volts > 25V)
Resolution:	Low	0.01Ω	1Ω
	High	0.1Ω	
Regulation:		< 2% for 90% load power change (Volts > 2V using remote sense)	< 2% for 90% load power change (Volts > 25V)
Temperature Coefficient:		< (±0.04% ± 5 mA) per °C	< (±0.04% ± 5 mA) per °C
(2) Slew Rate Range:	Low	< 1Ω per s to 100Ω per ms	1Ω per ms to 100Ω per µs
	High	< 40Ω per s to 4000Ω per ms	
Minimum Transition Time:		(3) 150 µs	(4) 150 µs
CG MODE			
Range:	Low	< 0.01-1A/V	0.001-1 A/V
	High	< 0.2-40A/V	
Accuracy:		± 0.5% ± 2 digits ± 30 mA	± 0.5% ± 2 digits ± 30 mA (Volts > 25V)
Resolution:	Low	1mA/V	1 mA/V
	High	0.01A/V	
Regulation:		< 2% for 90% load power change (Volts > 2V using remote sense)	< 2% for 90% load power change (Volts > 25V)
Temperature Coefficient:		< (±0.04% ± 5mA) per °C	< (±0.04% ± 5mA) per °C
(2) Slew Rate Range:	Low	<0.1A/V per s to >10A/V per ms	<0.1A/V per s to >10A/V per ms
	High	<4A/V per s to >400A/V per ms	
Minimum Transition Time:		(3) 150µs	(4) 150µs
CV MODE			
Range:	Low	Vmin-8V	N/A
	High	Vmin-80V	
(V min depends on current, typically <2V at 80A)			
Accuracy:		± 0.2% ± 2 digits	
Resolution:	Low	1mV	
	High	10mV	
Regulation:		< 30mV for 90% load power change (using remote sense)	
Temperature Coefficient:		<(0.02% + 1mV) per °C	
(2) Slew Rate Range:	Low	0.8V per s to >80V per ms	
	High	<8V per s to >800V per ms	
Minimum Transition Time:		(3) 150µs	

MODEL	LD400 & LD400P	LDH400P
TRANSIENT CONTROL		
TRANSIENT GENERATOR		
Pulse Repetition Rate:	Adjustable from 0-01Hz (100 seconds) to 10kHz	
Pulse Duty Cycle:	1% to 99% (percentage of period at Level A)	
Setting Accuracy:	±1 %	
Slew Rate Control:	The slew rate control applies to all changes of level whether caused by manual selection, remote control or the transient generator. The level change is a linear slew between the two level settings. The range available in each mode is shown previously.	
Setting Accuracy:	± 10% (on linear part of slope, excluding high frequency aberrations)	
Variation in Level Settings:	± 5 digits of specified setting resolution for present mode and range.	
OSCILLATOR SYNC OUTPUT		
Connection:	Terminal block on rear panel. Opto-isolated open collector output conducts during Level B phase of internal transient generator.	Terminal block on rear panel. Lo terminal output grounded to chassis internally. TTL/CMOS (5V) output. Conducts during Level B phase of internal transient generator.
Ratings:	Max offstate voltage: 30V. Collector current: 2mA (typical).	TTL/CMOS
DROPOUT VOLTAGE		
	The load will cease to conduct if the applied voltage falls below the Dropout Voltage setting; active in all modes. The Dropout Voltage setting is also the threshold for the Slow Start facility and acts as an offset voltage in Constant Resistance mode.	
Setting Accuracy:	± 2% ± 20mV	± 2% ± 200mV
Slow Start:	If Slow Start is enabled, the load will not conduct any current until the source voltage reaches the Dropout Voltage setting; it will then ramp the controlled variable up (in CC, CP and CG modes) or down (in CR and CV* modes) to the Level setting at a rate determined by the Slew Rate setting.	
*LD400 & LD400P models only		
METER SPECIFICATIONS		
Display Type:	256 x112 pixel graphic LCD with white LED backlight.	
MEASURED VALUES		
Volts & Amps:	Measured values of current through and voltage across the load.	
Watt & Ohms:	Power and equivalent load resistance, calculated from Volts and Amps.	
Voltage Accuracy:	± 0.1% ± 2 digits	± 0.1% ± 0.02%FS
Current Accuracy:	± 0.2% ± 3 digits	± 0.2% ± 0.04%FS
CURRENT MONITOR OUTPUT		
Output Terminals:	4mm safety sockets on front panel or terminal block on rear panel.	BNC (chassis grounded) on front panel or terminal block on rear panel.
Output Impedance:	600Ω nominal, for >1MΩ load (e.g. oscilloscope)	
Scaling:	50mV per Amp (4V full scale)	250mV per Amp (4V full scale).
Accuracy:	± 0.5% ± 5mV	
CURRENT MONITOR OUTPUT		
Common Mode Range:	± 3V dc max (5)	Chassis ground referenced
Bandwidth Limit (-3dB):	-	40kHz

MODEL	LD400 & LD400P	LDH400P
PROTECTION		
Excess Power:	The unit will attempt to limit the power to approx 430W; if this fails the unit will trip into the fault state at about 460 Watts. If intermittent mode operation is enabled, these levels are 610W and 630W.	The unit will attempt to limit the power to approx 430W; if this fails the unit will trip into the fault state at about 460W.
Protection Current:	The input is disabled if the measured current exceeds a user set limit.	
Excess Current:	The unit will trip into the fault state at nominally 92A.	The unit will trip into the fault state at nominally 20A. The unit is protected by fuses that protect the unit against currents that exceed 20A. This is primarily as a protection against high power sources with a current capability of >20A being connected to the load with reverse polarity.
Protection Voltage:	The input is disabled if the measured voltage exceeds a user set limit.	
Excess Voltage:	The unit will conduct a current pulse (to absorb inductively generated spikes) for 1ms at about 90V. The unit will trip into the fault state at nominally 106V. Surge suppressors will start to conduct above 120V.	The unit will conduct a current pulse (to absorb inductively generated spikes) for 1ms at about 510V. The unit will trip into the fault state at nominally 530V. Surge suppressors will start to conduct at typically 800V ± 20%.
Temperature:	The unit will trip into the fault state if the heatsink temperature exceeds safe levels.	
Reverse Polarity:	N/A	The unit will trip into the fault state if a reverse current is drawn that exceeds 200mA. The unit is protected by fuses that protect the unit against currents that exceed 20A.
REMOTE CONTROL (P MODELS ONLY)		
EXTERNAL CONTROL INPUT CHARACTERISTICS		
Connection:	Terminal block on rear panel.	Terminal block on rear panel. Lo terminal input grounded to chassis internally.
Input Impedance:	400kΩ each input to load negative.	10kΩ. Input protected against excess input voltages up to 50V.
Common Mode Range:	± 100V to load negative.	Chassis ground referenced
EXTERNAL ANALOG VOLTAGE CONTROL		
Operating Mode:	The applied voltage sets the operating level within the range.	
Scaling:	4 Volts full scale.	4 Volts full scale (250mV per Amp).
Accuracy:	± 2% ± accuracy of range.	
Common Mode Rejection:	Better than -66dB	Better than -76dB

MODEL	LD400 & LD400P	LDH400P
EXTERNAL LOGIC LEVEL (TTL) CONTROL		
Operating Mode:	The applied signal selects between Level A and Level B settings.	
Threshold:	+ 1.5V nominal. A logic high selects Level B.	
REMOTE DISABLE INPUT		
Connection:	Terminal block on rear panel. Input to the LED of an opto-isolator through 1kΩ resistor.	
Threshold:	Apply >+3V to disable the load input. Max. 12V.	
GENERAL		
AC Input:	110V–120V or 220V–240V AC ±10%, 50/60Hz. Installation Category II	
Power Consumption:	40VA max. Mains lead rating: 6A minimum.	40VA max. Mains lead rating: 6A minimum.
Operating Range:	+ 5°C to + 40°C, 20% to 80% RH	
Storage Range:	– 40°C to + 70°C	
Environmental:	Indoor use at altitudes up to 2000m, Pollution Degree 2.	
Cooling:	Variable speed fan. Air exit at rear.	
Safety:	Complies with EN61010-1	
EMC:	Complies with EN61326	
Size:	130mm H (3U) x 212mm W (½ rack) x 435mm D	
Weight:	5.7 kg	
Option:	RM460- 19-inch rack mount kit	

SPECIFICATION NOTES

LD400 & LD400P Accuracy specifications apply for 18°C – 28°C, at 50W load power (in normal 400W mode), after 30 minutes operation at the set conditions; regulation specifies variation at other powers. Setting accuracies apply with slew rate at the 'Default' setting.

LDH400P Accuracy specifications apply for 18°C – 28°C, using rear panel terminals, after 30 minutes operation at the set conditions. Setting accuracies apply with slew rate at the 'Default' setting.

(1) In 600 Watt short-term operation mode the dynamic response is not specified, and both the slew rate and the transient oscillator frequency range are restricted. The slew rate limitation applies also to external voltage control. This mode is primarily intended for limited duration operation at a fixed level setting.

(2) Slew Rate Ranges refer to the theoretical slope of the transition between two levels, regardless of whether that transition can be achieved when taking into account the level difference, the set transition duration, the minimum transition time, and the characteristics of the source.

(3) Minimum Transition Time specification is an indication of the fastest available transition using a benign battery source and low inductance connections, with a minimum terminal voltage of 5V and a minimum current of 1A. The actual performance attainable with electronically regulated power supplies depends on the combination of source and load loop bandwidths and interconnection inductance.

(4) Minimum Transition Time specification is an indication of the fastest available transition using a benign source and low inductance connections, with a minimum terminal voltage of 25V and a minimum current of 200mA. The actual performance attainable with electronically regulated power supplies depends on the combination of source and load loop bandwidths and interconnection inductance.

(5) The common mode capability of the current monitor is to provide tolerance of voltage drops in the cables. The monitor negative must be connected at some point to the load negative circuit.

Designed and built in Europe by:



THURLBY THANDAR INSTRUMENTS LTD.

Glebe Road, Huntingdon, Cambridgeshire, PE29 7DR, United Kingdom

Tel: +44 1480 412451 Fax: +44 1480 450409

Email: info@aimtti.com Web: www.aimtti.com