

**PLEASE CHECK WWW.MOLEX.COM FOR LATEST PART INFORMATION**

**Part Number:** **0466220500**  
**Status:** **Active**  
**Overview:** Micro-Fit 3.0 Connector System Product Family  
**Description:** Micro-Fit BMI™ Header, Surface Mount, Single Row, Right Angle, with Solder Tab, Tin (Sn) Plating, 5 Circuits

**Documents:**

[Drawing \(PDF\)](#) [RoHS Certificate of Compliance \(PDF\)](#)  
[Packaging Specification PK-46622-001 \(PDF\)](#) [Product Literature \(PDF\)](#)

**General**

Product Family	PCB Headers
Series	46622
Application	Power, Wire-to-Board
Overview	<u>Micro-Fit 3.0 Connector System Product Family</u>
Product Literature Order No	987650-5984
Product Name	Micro-Fit BMI™
UPC	191128235617

**Physical**

Breakaway	No
Circuits (Loaded)	5
Circuits (maximum)	5
Color - Resin	Black
Durability (mating cycles max)	30
First Mate / Last Break	No
Glow-Wire Compliant	No
Guide to Mating Part	No
Keying to Mating Part	None
Lock to Mating Part	Yes
Material - Metal	Brass
Material - Plating Mating	Tin
Material - Plating Termination	Tin
Material - Resin	Liquid Crystal Polymer
Net Weight	1.451/g
Number of Rows	1
Orientation	Right Angle
PCB Locator	Yes
PCB Retention	Yes
Packaging Type	Embossed Tape on Reel
Pitch - Mating Interface	3.00mm
Plating min - Mating	1.524µm
Plating min - Termination	1.524µm
Polarized to Mating Part	Yes
Polarized to PCB	Yes
Shrouded	Fully
Stackable	No
Temperature Range - Operating	-40°C to +105°C
Termination Interface: Style	Surface Mount

**Electrical**

Current - Maximum per Contact	7.0A
Voltage - Maximum	600V

**Solder Process Data**

Duration at Max. Process Temperature (seconds)	030
Lead-free Process Capability	REFLOW

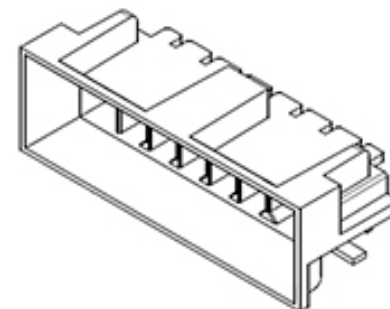

*Series image - Reference only*

**EU ELV**

**Not Relevant**

**EU RoHS**

**Compliant**

**REACH SVHC**

Not Contained Per -  
ED/30/2017 (7 July  
2017)

**Halogen-Free**

**Status**

**Low-Halogen**

**Need more information on product environmental compliance?**

Email [productcompliance@molex.com](mailto:productcompliance@molex.com)  
Please visit the [Contact Us](#) section for any non-product compliance questions.

China ROHS	Green Image
ELV	Not Relevant
RoHS Phthalates	Not Contained

**Search Parts in this Series**

[46622 Series](#)

**Mates With**

[46623 Micro-Fit BMI™ Panel Mount Receptacle Housing](#)

Max. Cycles at Max. Process Temperature	003
Process Temperature max. C	260

**Material Info**

**Reference - Drawing Numbers**

Packaging Specification	PK-46622-001
Sales Drawing	SD-46622-0000

This document was generated on 08/29/2017

**PLEASE CHECK [WWW.MOLEX.COM](http://WWW.MOLEX.COM) FOR LATEST PART INFORMATION**