

**PLEASE CHECK WWW.MOLEX.COM FOR LATEST PART INFORMATION**

**Part Number:** [0466250400](#)  
**Status:** **Active**  
**Overview:** [Micro-Fit 3.0 Connector System Product Family](#)  
**Description:** [Micro-Fit BMI™ Plug Housing, Single Row, Panel Mount, 4 Circuits, Nylon, UL 94V-0](#)

**Documents:**

[Drawing \(PDF\)](#) [RoHS Certificate of Compliance \(PDF\)](#)  
[Packaging Specification 466250000-PK-000 \(PDF\)](#) [Product Literature \(PDF\)](#)

**Agency Certification**

CSA LR19980  
 UL E29179

**General**

Product Family Crimp Housings  
 Series [46625](#)  
 Application Power, Wire-to-Board, Wire-to-Wire  
 Overview [Micro-Fit 3.0 Connector System Product Family](#)  
 Product Literature Order No 987650-5984  
 Product Name Micro-Fit BMI™  
 UPC 887191386607

**Physical**

Circuits (maximum) 4  
 Color - Resin Black  
 Flammability 94V-0  
 Gender Plug  
 Glow-Wire Compliant No  
 Lock to Mating Part No  
 Material - Resin Nylon  
 Net Weight 1.761/g  
 Number of Rows 1  
 Packaging Type Bag  
 Panel Mount Yes  
 Pitch - Mating Interface 3.00mm  
 Polarized to Mating Part Yes  
 Stackable No  
 Temperature Range - Operating -40°C to +105°C

**Solder Process Data**

Lead-freeProcess Capability N/A

**Material Info**

**Reference - Drawing Numbers**

Packaging Specification 466250000-PK-000  
 Sales Drawing SD-46625-001-001

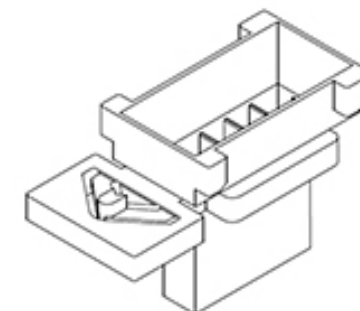

*Series image - Reference only*

**EU ELV**

**Not Relevant**

**EU RoHS**

**Compliant**

**China RoHS**

**REACH SVHC**

Not Contained Per -  
 ED/30/2017 (7 July  
 2017)

**Halogen-Free**

**Status**

**Low-Halogen**

**Need more information on product  
 environmental compliance?**

Email [productcompliance@molex.com](mailto:productcompliance@molex.com)  
 Please visit the [Contact Us](#) section for any  
 non-product compliance questions.

China ROHS Green Image  
 ELV Not Relevant  
 RoHS Phthalates Not Contained

**Search Parts in this Series**

[46625](#) Series

**Mates With**

[46623](#) Micro-Fit BMI™ Receptacle Housing

**Use With**

[43031](#) Micro-Fit 3.0™ Male Crimp Terminals