



GDM 3009 schwarz/black

Industrial Connectors:Rectangular connectors GDM-series:Type AEN 175301-803 (DIN 43650) / ISO 4400:Cable socket, self-assembly

Product description

Description	cable socket with central screw M 3 x 35
Type	GDM 3009 schwarz/black
Order No.	931 969-100
Other standard types	grey housing, Order no. 931 969-106
Number of contacts	3 + PE
Cable gland	PG 9
Conductor size	max. 1.5 mm ²
Standard	DIN EN 175 301-803-A
Housing Color	black
Construction type	A

Drawing

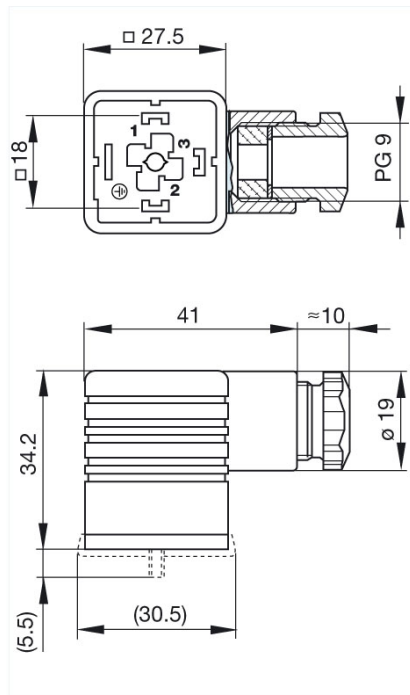

Technical data

Pin dimensions	6.3 mm x 0.8 mm, 4.8 mm x 0.8 mm
Rated voltage	AC/DC 250 V
Rated current	16 A
Contact resistance	≤ 4 mΩ
Type of termination	screw
Suitable cables	4.5 mm to 7 mm diameter

Mounting	central nut
Material	
Contact surface material	Sn
Contact bearer material	PA
Housing material	PA
Environmental conditions	
Protection class (IEC 60529)	IP 65 (gasket necessary)
Pollution severity	3
Temperature range	-40 °C to +125 °C
Inflammability class	
Housing	94 HB
Contact bearer	94 HB
Approvals	
VDE	VDE
SEV	SEV
CSA	CSA
Packing unit	
Packaging unit	200 pieces
Scope of delivery and accessories	
Accessories to order separately	(NBR) flat gasket GDM 3-7, Order no. 730 801-002; (EPDM) flat gasket GDM 3-21, Order no. 731 739-004; profiled gasket GDM 3-16, Order no. 731 531-002; knurled screw GDM 3011-8, Order no. 732 574-001; stainless steel screw GDM 3011 RF-1, Order no. 734 363-001