

50 ohm, conjugate match to CC253x, CC254x, CC257x, CC852x, CC853x, transformer balun

Datasheet – production data

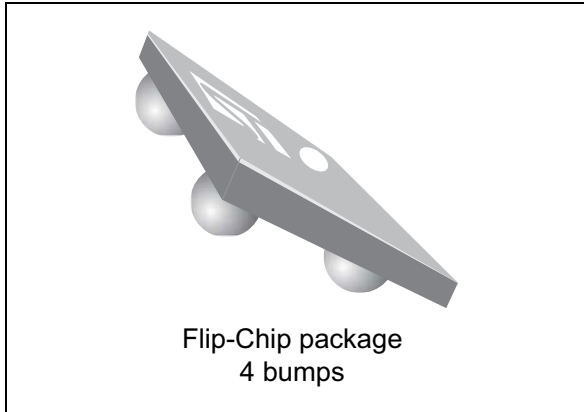

## Description

STMicroelectronics BAL-CC25-01D3 is an ultra miniature balun which integrates a matching network in a monolithic glass substrate. This has been customized for the CC25xx and CC85xx RF transceivers.

It's a design using STMicroelectronics IPD (integrated passive device) technology on non-conductive glass substrate to optimize RF performance.

## Features

- 2.45 GHz balun with integrated matching network
- Matching optimized for following chip-sets:
  - CC2530, CC2531, CC2533
  - CC2540
  - CC2543, CC2544, CC2545
  - CC2570, CC2571
  - CC8520, CC8521
  - CC8530, CC8531
- Low insertion loss
- Low amplitude imbalance
- Low phase imbalance
- Coated Flip-Chip on glass
- Small footprint: < 0.88 mm<sup>2</sup>

## Benefits

- Very low profile
- High RF performance
- PCB space saving versus discrete solution
- BOM count reduction
- Efficient manufacturability

Figure 1. Pin configuration (top view)

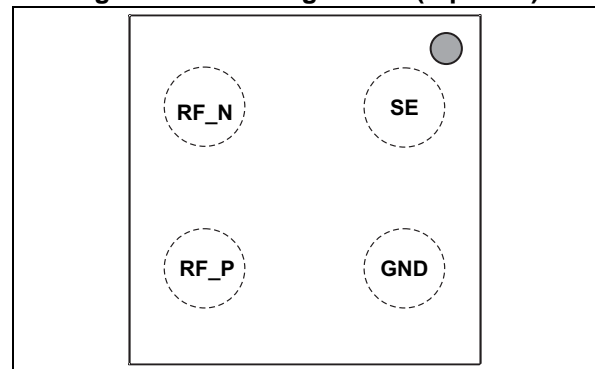
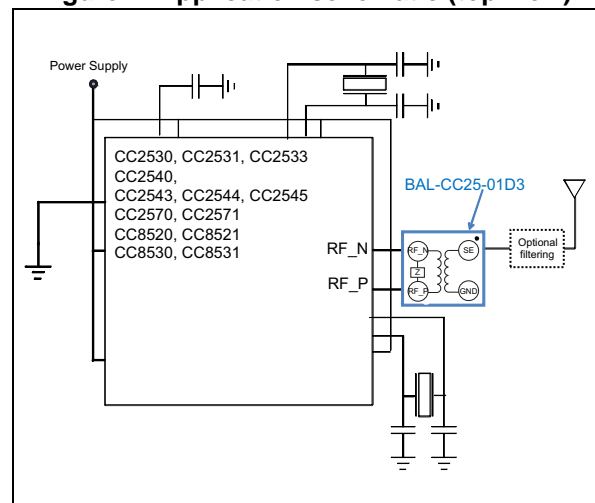

Figure 2. Application schematic (top view)



# 1 Characteristics

**Table 1. Absolute maximum rating (limiting values)**

Symbol	Parameter	Value			Unit
		Min.	Typ.	Max.	
P <sub>PEAK</sub>	Input power RF <sub>IN</sub>		20		dBm
V <sub>ESD</sub>	ESD ratings MIL STD883C (HBM: C = 100 pF, R = 1.5 kΩ, air discharge)	2000			V
	ESD ratings machine model (MM: C = 200 pF, R = 25 Ω, L = 500 nH)	500			
	ESD ratings charged device model (CDM, JESD22-C101D)	500			
T <sub>OP</sub>	Operating temperature	-40		+125	°C

**Table 2. Electrical characteristics - RF performance (T<sub>amb</sub> = 25 °C)**

Symbol	Parameter	Value			Unit
		Min.	Typ.	Max.	
Z <sub>OUT</sub>	Nominal differential output impedance	Conjugate match to CC25xx, CC85xx			Ω
Z <sub>IN</sub>	Nominal input impedance				
F	Frequency range (bandwidth)	2379		2507	
I <sub>L</sub>	Insertion loss in bandwidth		0.66		dB
R <sub>L_SE</sub>	Single ended return loss in bandwidth		19		dB
R <sub>L_DIFF</sub>	Differential ended return loss in bandwidth		19		dB
Φ <sub>imb</sub>	Phase imbalance		14		°
A <sub>imb</sub>	Amplitude imbalance		0.3		dB

Figure 3. Insertion loss ( $T_{amb} = 25\text{ }^{\circ}\text{C}$ )

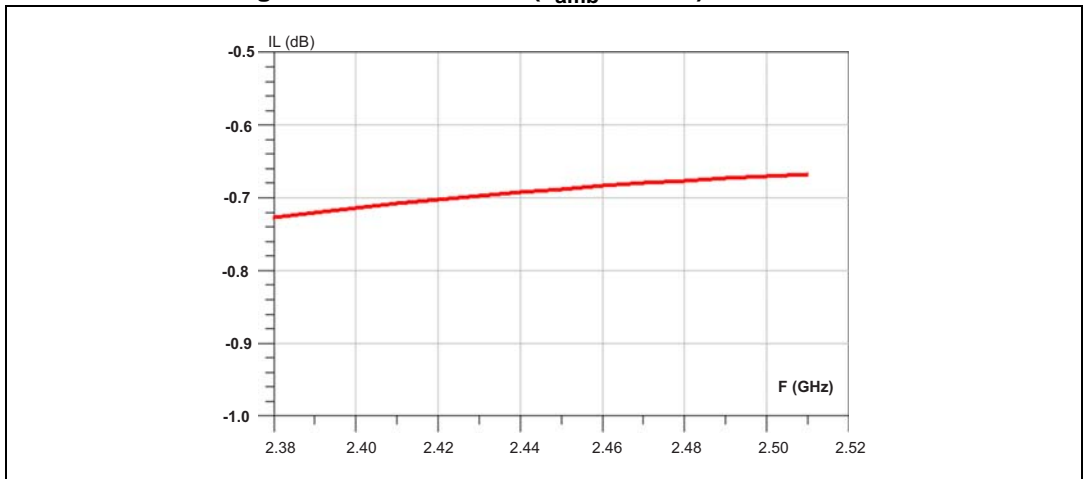

Figure 4. Return loss ( $T_{amb} = 25\text{ }^{\circ}\text{C}$ )

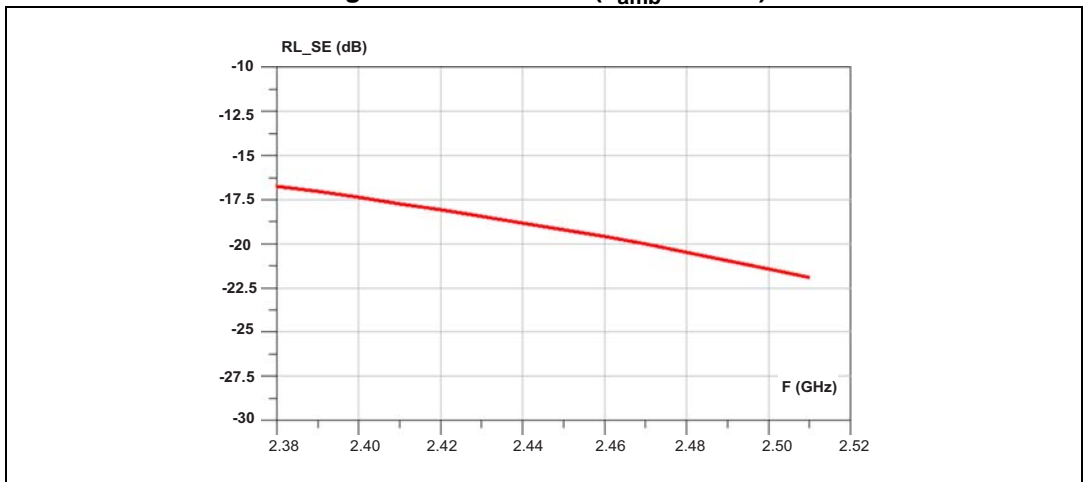

Figure 5. Return loss ( $T_{amb} = 25\text{ }^{\circ}\text{C}$ )

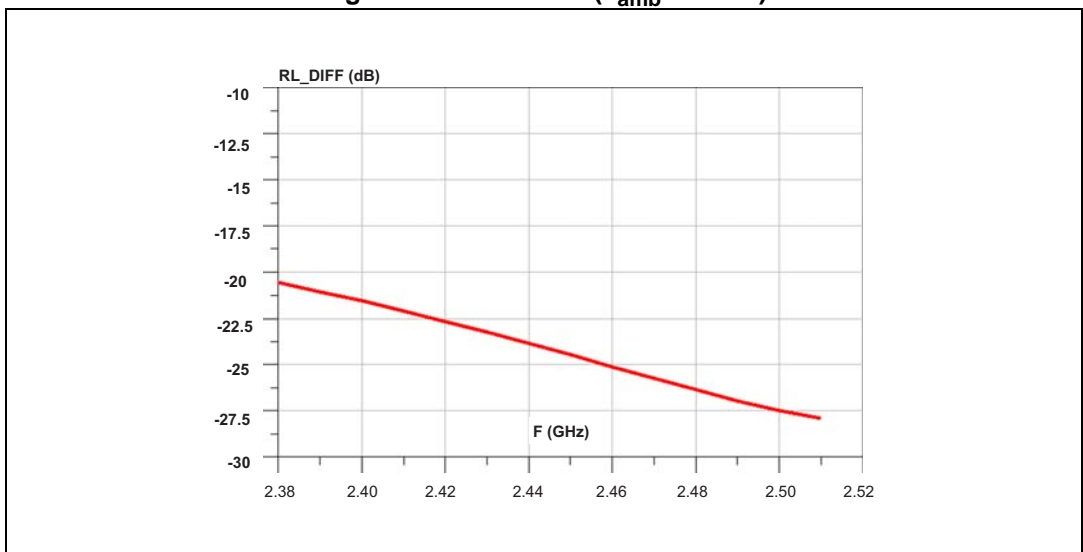

Figure 6. Amplitude imbalance ( $T_{amb} = 25\text{ }^{\circ}\text{C}$ )

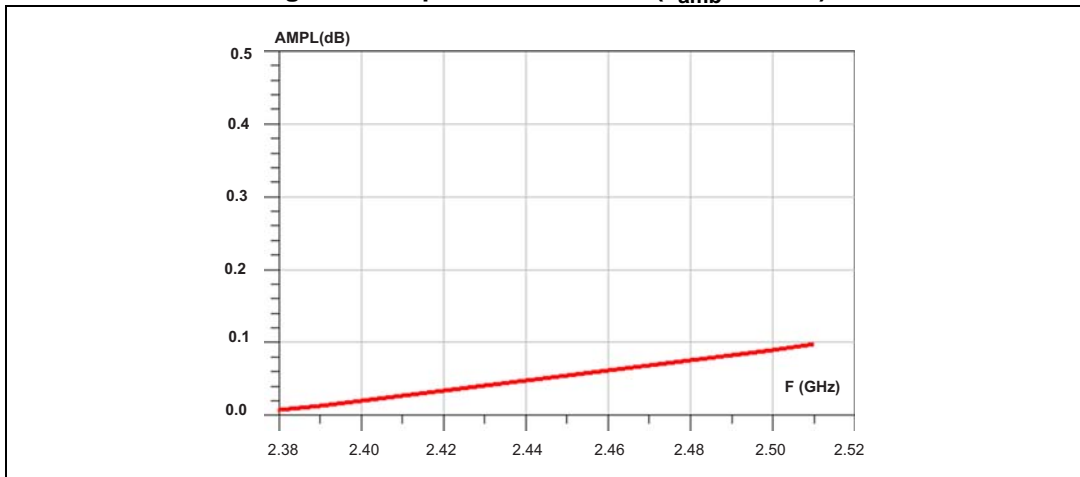
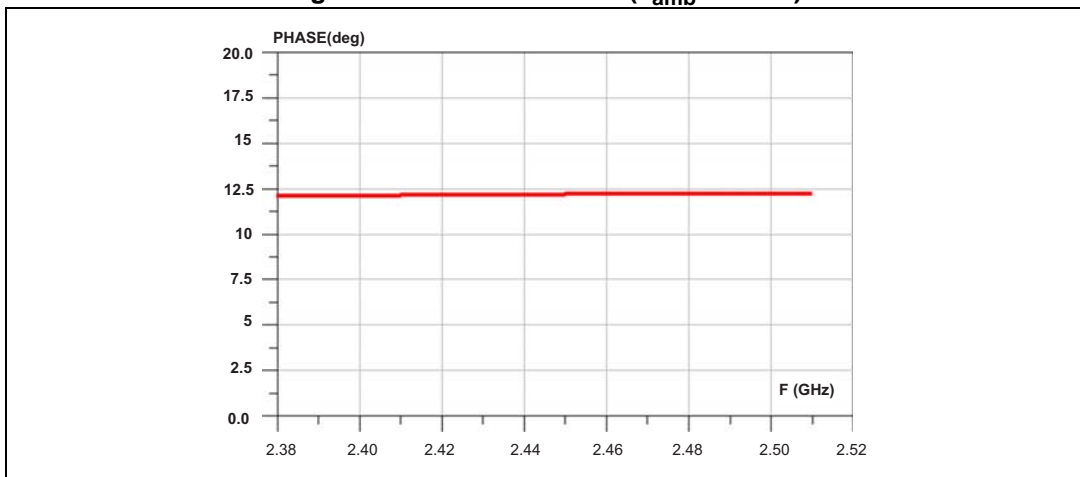

Figure 7. Phase imbalance ( $T_{amb} = 25\text{ }^{\circ}\text{C}$ )



## 2 Package information

- Epoxy meets UL94, V0
- Lead-free package

In order to meet environmental requirements, ST offers these devices in different grades of ECOPACK® packages, depending on their level of environmental compliance. ECOPACK® specifications, grade definitions and product status are available at: [www.st.com](http://www.st.com). ECOPACK® is an ST trademark.

### 2.1 Flip-Chip package information

Figure 8. Flip-Chip package outline

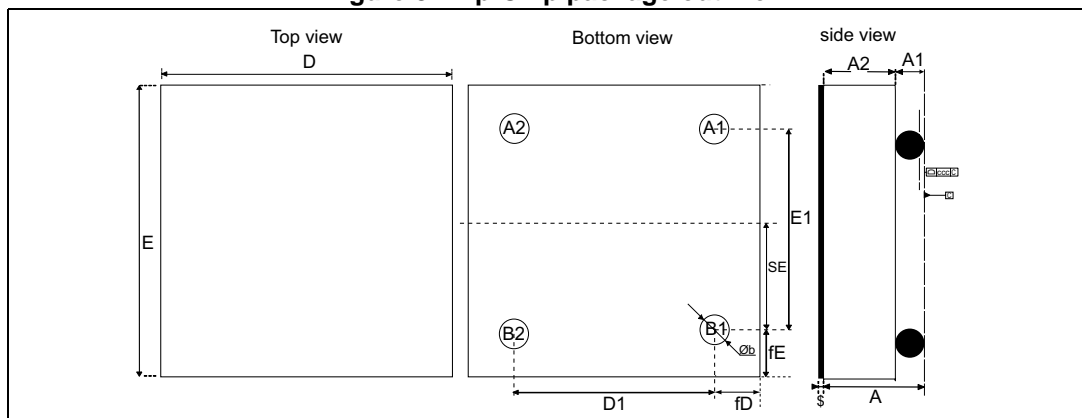

Table 3. Flip-Chip package mechanical data

Parameter	Description	Min.	Typ.	Max.	Unit
A	Bump height + substrate thickness	0.570	0.630	0.690	mm
A1	Bump height	0.155	0.205	0.255	mm
A2	Substrate thickness		0.400		mm
b	Bump diameter	0.215	0.255	0.295	mm
D	Y dimension of the die	0.890	0.940	0.990	mm
D1	Y pitch		0.500		mm
E	X dimension of the die	0.890	0.940	0.990	mm
E1	X pitch		0.500		mm
SE			0.250		mm
fD	Distance from bump to edge of die on Y axis		0.220		mm
fE	Distance from bump to edge of die on X axis		0.220		mm
ccc				0.05	mm
\$			0.025		mm

Figure 9. Footprint

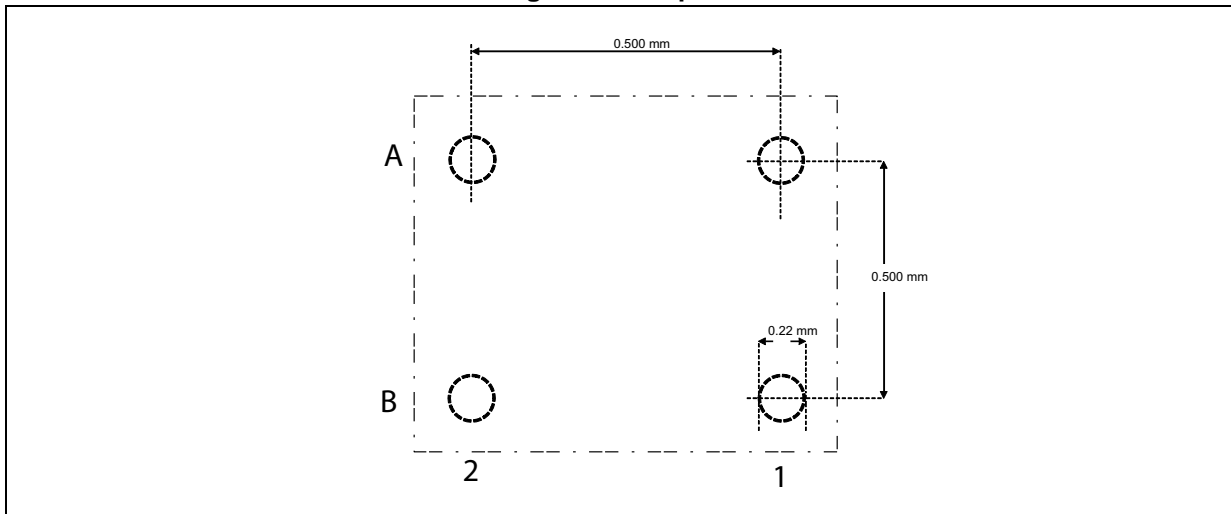

Figure 10. Footprint - 3 mils stencil - non solder mask defined

Copper pad diameter:  
220  $\mu\text{m}$  recommended  
180  $\mu\text{m}$  minimum  
260  $\mu\text{m}$  maximum

Solder mask opening:  
320  $\mu\text{m}$  recommended  
300  $\mu\text{m}$  minimum  
340  $\mu\text{m}$  maximum

Solder stencil opening:  
220  $\mu\text{m}$  recommended

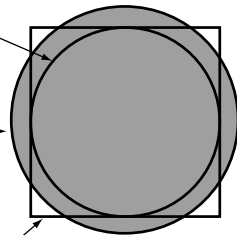

Figure 11. Footprint - 3 mils stencil - solder mask defined

Solder mask opening:  
220  $\mu\text{m}$  recommended  
180  $\mu\text{m}$  minimum  
260  $\mu\text{m}$  maximum

Copper pad diameter:  
320  $\mu\text{m}$  recommended  
300  $\mu\text{m}$  minimum

Solder stencil opening:  
220  $\mu\text{m}$  recommended

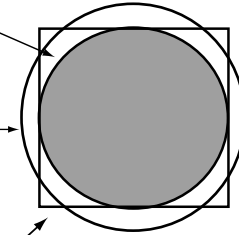

Figure 12. Footprint - 5 mils stencil - non solder mask defined

Copper pad diameter:  
220  $\mu\text{m}$  recommended  
180  $\mu\text{m}$  minimum  
260  $\mu\text{m}$  maximum

Solder mask opening:  
320  $\mu\text{m}$  recommended  
300  $\mu\text{m}$  minimum  
340  $\mu\text{m}$  maximum

Solder stencil opening:  
330  $\mu\text{m}$  recommended\*

\*depending on paste, it can go down to 270  $\mu\text{m}$

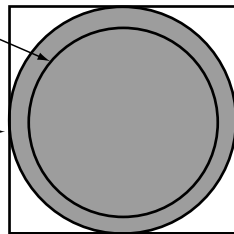

Figure 13. Footprint - 5 mils stencil - solder mask defined

Solder mask opening:  
220  $\mu\text{m}$  recommended  
180  $\mu\text{m}$  minimum  
260  $\mu\text{m}$  maximum

Copper pad diameter:  
320  $\mu\text{m}$  recommended  
300  $\mu\text{m}$  minimum

Solder stencil opening:  
330  $\mu\text{m}$  recommended\*

\*depending on paste, it can go down to 270  $\mu\text{m}$

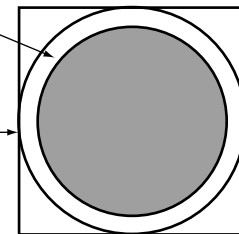

Figure 14. PCB layout recommendation

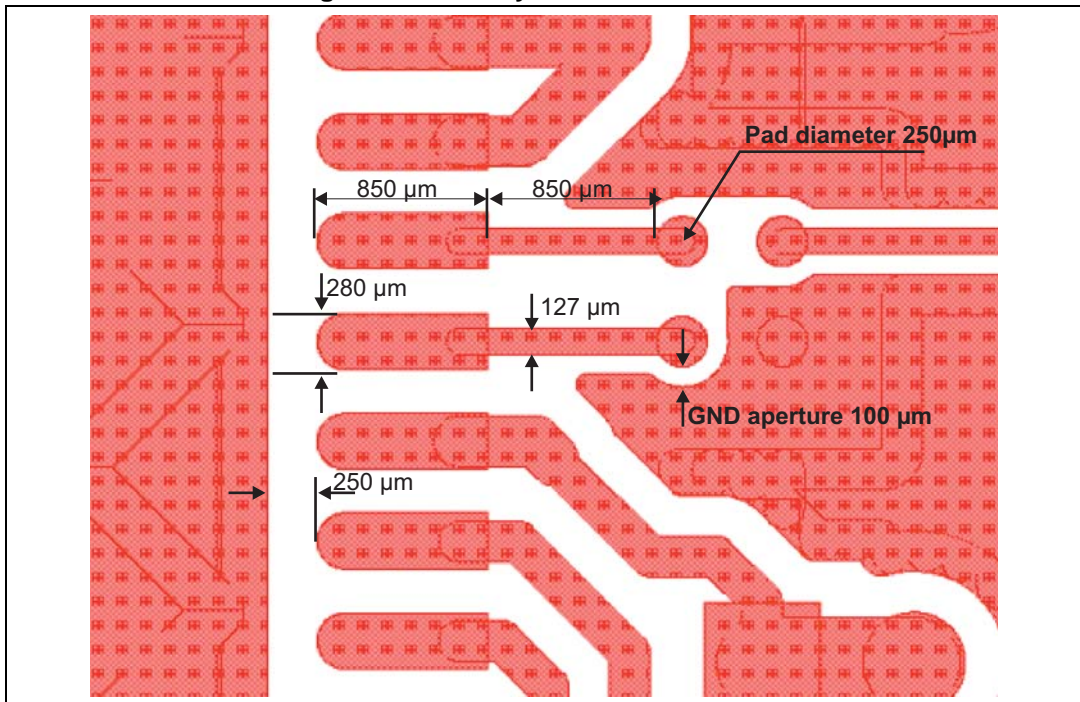
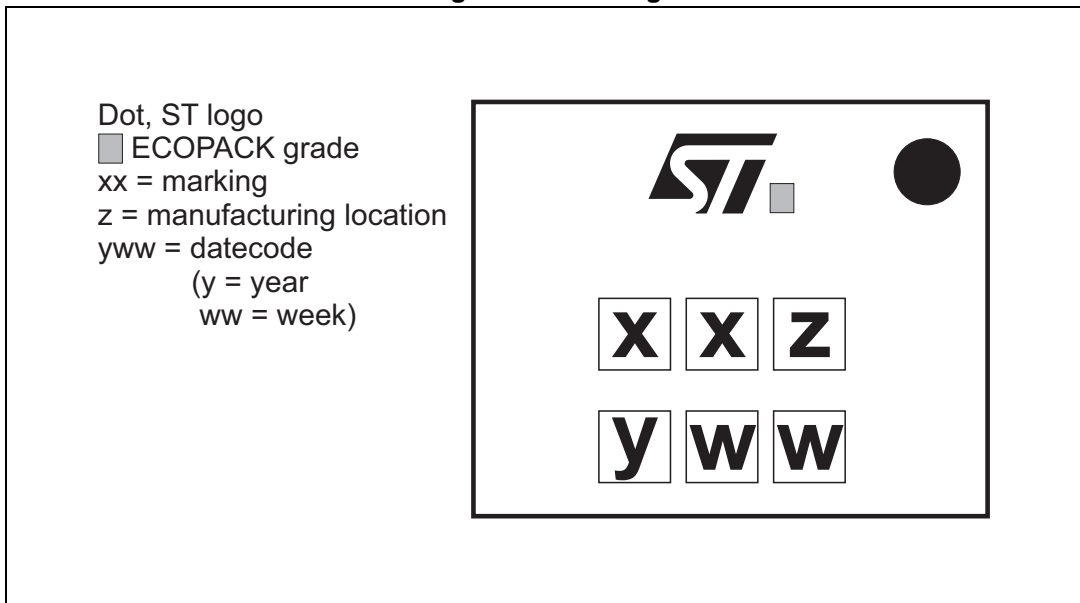
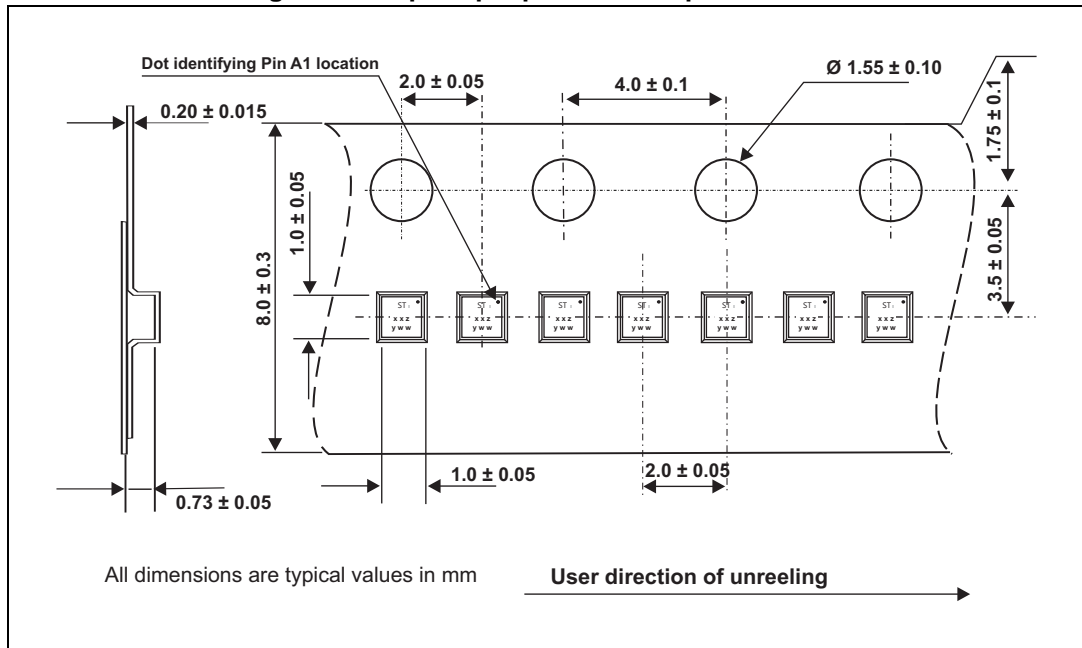

Figure 15. Marking



Note: More information is available in the STMicroelectronics Application note: AN2348 Flip-Chip: "Package description and recommendations for use"

Figure 16. Flip Chip tape and reel specifications



Note: More information is available in the application note:  
 AN2348: "Flip Chip: package description and recommendations for use"



### 3 Ordering information

**Table 4. Ordering information**

Order code	Marking	Package	Weight	Base qty	Delivery mode
BAL-CC25-01D3	SL	Flip Chip	1.07 mg	5000	Tape and reel (7")

### 4 Revision history

**Table 5. Document revision history**

Date	Revision	Changes
23-May-2013	1	Initial release
11-Jul-2013	2	Updated Figure 14.
04-Sep-2015	3	Updated Figure 8. Added Figure 10, Figure 11, Figure 12, Figure 13 and Table 3.
12-Nov-2015	4	Updated <a href="#">Table 1</a> .

**IMPORTANT NOTICE – PLEASE READ CAREFULLY**

STMicroelectronics NV and its subsidiaries ("ST") reserve the right to make changes, corrections, enhancements, modifications, and improvements to ST products and/or to this document at any time without notice. Purchasers should obtain the latest relevant information on ST products before placing orders. ST products are sold pursuant to ST's terms and conditions of sale in place at the time of order acknowledgement.

Purchasers are solely responsible for the choice, selection, and use of ST products and ST assumes no liability for application assistance or the design of Purchasers' products.

No license, express or implied, to any intellectual property right is granted by ST herein.

Resale of ST products with provisions different from the information set forth herein shall void any warranty granted by ST for such product.

ST and the ST logo are trademarks of ST. All other product or service names are the property of their respective owners.

Information in this document supersedes and replaces information previously supplied in any prior versions of this document.

© 2015 STMicroelectronics – All rights reserved