



# Prestigio

THE ART OF HI-TECH



## Car Video Recorder

RoadRunner 545 / RoadRunner 545GPS

### User Manual

Version 1.0

[www.prestigio.com](http://www.prestigio.com)

## About this user manual

This user manual is specially designed to detail the device's functions and features.

- Please read this manual before using the device to ensure safe and proper use.
- Descriptions are based on the device's default settings.
- Prestigio continuously strives to improve its products. Due to software upgrading, some contents in this user manual may be different from your product. Prestigio reserves the rights to revise this user manual or withdraw it at any time without prior notice. Please take your product as standard.

## Conventions used in this manual

In this user manual, we use the following symbols to indicate useful and important information:



**Caution:** provides safety precaution and important information.



**Note:** gives additional information.



**Tips:** usage tips.

- > The order of options or menus you must select to perform a step.

### **Note:**

***The italicized text in this manual is only for RoadRunner 545GPS.***

# Contents

<b>1. Unboxing .....</b>	<b>1</b>
Inside your package .....	1
Device overview .....	1
<b>2. Getting started.....</b>	<b>2</b>
Insert a microSD card .....	2
Install the suction mount .....	2
Charge the battery .....	2
Main screen.....	3
<b>3. Settings.....</b>	<b>4</b>
Video settings.....	4
Picture settings.....	4
General settings .....	4
<b>4. Recording.....</b>	<b>5</b>
Record a video .....	5
Take a picture.....	5
<b>5. File management .....</b>	<b>6</b>
Browse files .....	6
Delete a file .....	6
Lock and unlock a file .....	6
<b>6. Playback.....</b>	<b>6</b>
Play video on DVR .....	6
Playback on your TV/Monitor .....	6
Playback on GPS video player .....	6
<b>7. Specifications .....</b>	<b>7</b>

# 1. Unboxing



## Inside your package

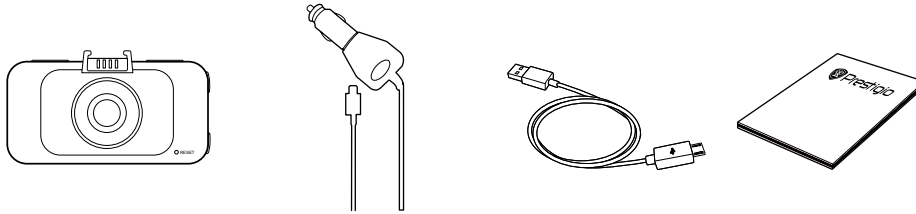

RoadRunner 545



RoadRunner 545GPS

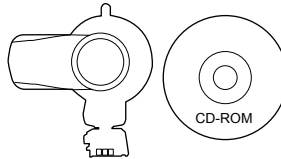

- Car video recorder
- Mini USB cable
- CD
- Warranty card

- Car charger
- Suction mount
- Quick start guide

## Device overview

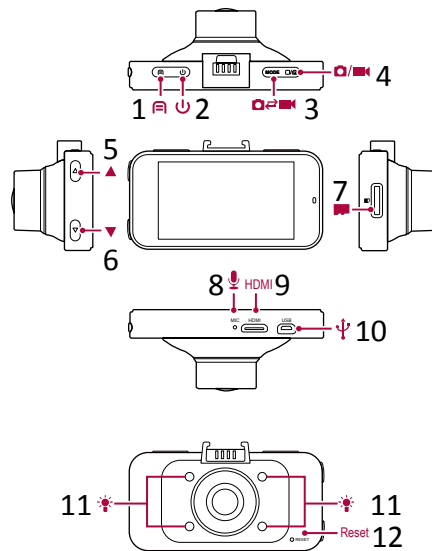

- 1 Menu button
- 2 Power button
- 3 Mode button
- 4 Record/Playback/OK button
- 5 Up button
- 6 Down button

- 7 SD card slot
- 8 Microphone
- 9 HDMI port
- 10 Mini USB port
- 11 Infrared light
- 12 Reset button

## 2. Getting started

# 2

### Insert a microSD card

Before starting video recording, please insert a microSD card (not included) into the slot until it locks in place.

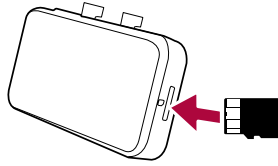

The device will automatically recognize it as default storage and all the data will be saved on this card.

### Install the suction mount

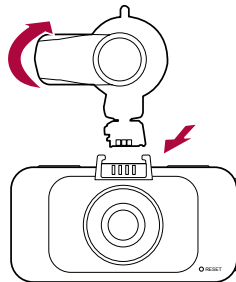

1. Match the mounting slots of the device and the suction mount, and press the suction mount until it locks in place.
2. Remove the protection plastic film from the suction cup, and position the device on the clean windshield or dashboard.
3. Hold firmly against the surface and rotate the lock knob. The mount will suction and stick firmly onto the surface.



To unmount, press the buckle and pull out the suction mount.

### Charge the battery

Before using the device for the first time, please fully charge the Li-ion battery. The battery will be completely charged in 2-3 hours.

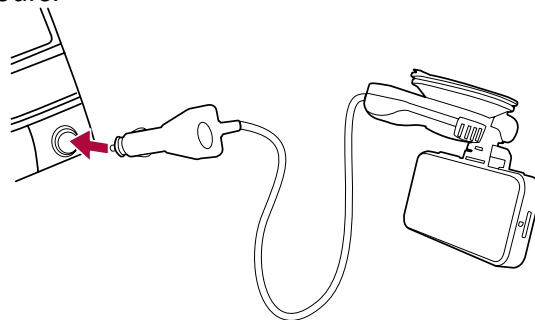

- Using the car charger: charge the device through cigarette lighter. The device will start charging after the car engine is turned on.



The GPS receiver is built in the suction mount. Please connect the car charger to the mini USB port on the mount.

- Using the included mini USB cable: connect the device to AC 5V adapter or the USB port of a computer/laptop.

## Main screen

Press power button to turn on device, you will enter preview mode, and get below screen:



- |   |                |    |             |
|---|----------------|----|-------------|
| 1 | Recording icon | 8  | G-Sensor    |
| 2 | Resolution     | 9  | Exposure    |
| 3 | Infrared light | 10 | Memory card |
| 4 | Recording time | 11 | Date        |
| 5 | Loop recording | 12 | Time        |
| 6 | Motion detect  | 13 | Battery     |
| 7 | HDR            | 14 | Microphone  |



When the device is connected to the GPS signal, the icon  will be green.

# 3. Settings



Before recording, you can set up the device according to your requirements.

- In video/picture preview mode, press [F6] to enter video/picture settings, press [MODE] to go to general settings, press [F6] again to exit.
- In setting list, use [▲]/[▼] to navigate the menu, press [O/⊗] to confirm the selection, and [MODE] to exit.

## Video settings

- **Resolution:** Select the resolution of recorded video: 1080FHD / 1920x1080(30 fps), 720P / 1280x720(60 fps), WVGA / 1280x720(30 fps), VGA / 640x480(30 fps).
- **Loop recording:** Set the video duration ( 1, 3, 5, or 10 minutes) for loop recording. When the microSD card is full, the device will delete the oldest unlocked video file automatically.
- **HDR:** HDR brings out the details of both the highlights and shadows, even in high contrast lighting.
- **Motion detection:** Turn on or off motion detection. If there is any motion detected while the car engine is stopped, your car DVR will start recording automatically.
- **Power on record:** Set DVR to start recording when power on.
- **Power off delay:** Select a time span for DVR to power off when the car engine stops.
- **Power on delay:** Select a time span for DVR to power on when the car engine starts.
- **Record audio:** Set to turn the microphone on or off.
- **G-sensor set:** Select the sensitivity of the G-sensor. The smaller the number is, the higher the sensitivity is. When reaching the sensitive value (such as collision), the recording file will be automatically protected.
- **GPS auto update time:** Set the GPS to update the date/time automatically.
- **GMT setup:** Select the local GMT (Greenwich Mean Time).
- **GPS set up:** Turn on or off GPS.
- **Speed cam:** Select to get overspeed warning or not.

## Picture settings

- **Resolution:** Select the picture image size.
- **Capture mode:** Select the capture mode from Single/ 2S Timer/5S Timer/10S Timer.
- **Sequence:** Turn on to capture three photos continuously.
- **Quality:** Select quality from Fine / Normal / Economy.
- **Sharpness:** Adjust the sharpness.
- **Color:** Select color from normal / black & white / sepia.
- **Quick review:** Set photo review time (2s, 5s) after shooting in preview mode.

## General settings

- **Date/Time:** Set date and time on device.
- **Car number set:** Set the car plate number if necessary.
- **Stamp:** Add information stamp onto videos/photos.
- **Auto power off:** Set automatic power off when the device is not in use.
- **Auto LCD off:** Set automatic LCD off when the device is not in use, press any button to wake up.
- **Beep sound:** Turn on or off beep sound.
- **Language:** Choose your language.
- **Format:** Format the memory card.



Formatting will erase all your stored data. Back up your data before proceeding.

- **TV mode:** Choose your TV type from NTSC, and PAL.
- **Frequency:** For a given luminance, the frequency of light fluctuation that evokes a sensation of

flicker. Set a right flickering frequency to avoid horizontal stripe interference.

- **Volume:** Set the playing volume.
- **Exposure:** Set exposure value to determine how much light the camera's sensor receives. For lowlight situations, use a higher exposure.
- **White balance:** Select an appropriate white balance, so images have a true-to-life color range. It is for specific lighting situations.
- **Default setting:** Restore to default setting.
- **Version:** Display the current system version.

# 4

## 4. Recording

### Record a video

#### Auto video recording

Connect the device to car charger, when the car engine launches, the device will automatically turn on and start loop video recording. When shut off the car engine, the device will save the last file and turn off.



You can cancel it by turning off POWER ON RECORD in settings.

#### Manual video recording

In preview mode, press [O/📷] button to start and stop video recording.

#### Capture a picture

During recording, press [📷] to take a photo.

#### Record the sound

In preview mode or recording mode, press [▲] to turn on or off microphone.

#### Turn on infrared light

During recording, press [🔦] to turn on infrared light to get more light in dark.

#### Lock a recording video

During recording, press [MODE] to lock the video.

### Take a picture

Press [MODE] to select the picture mode, and then press [O/📷] to take photos.

#### Zoom in or out

In photo mode, press [▲]/[▼] to zoom in or out.



# 5. File management



You can manage your videos and pictures in playback mode.

## Browse files

1. In preview mode, press [MODE] two times to enter the playback mode.
2. Press [▲]/[▼] to select your desired file.

## Delete a file

Open the file, press [⌘] to open menu, delete one file or all the files, and press it again to exit the menu.

## Lock and unlock a file

In playback mode, press [⏻] to protect or unprotect the selected file.

# 6. Playback

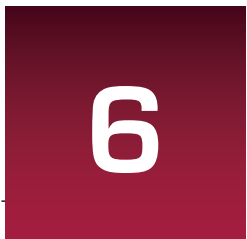

## Play video on DVR

1. In playback mode, press [▲]/[▼] to select your desired video.
2. Press [□/⊗] to open the file, and press it again to start playing.
3. Press [▲]/[▼] to slow down or speed up playing.
4. Press [□/⊗] to stop playing, and press [MODE] to exit playback mode.

## Playback on your TV/Monitor

1. Connect the car DVR to a TV/Monitor with a HDMI cable (not included).
2. Turn on the car DVR. Follow the instructions on the TV screen or refer to your TV user manual.

## Playback on GPS video player

1. Install the "Player.exe" stored on the CD-ROM included to your PC.
2. Connect the car DVR to the PC by the included mini USB cable.
3. Open the player, select the file and start playback.
4. It will show your video and tracks.



# 7. Specifications

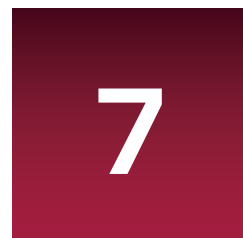

<b>Display</b>	2.7", 960 x 240 pixels
<b>Processor</b>	Novatek NT96650
<b>Image sensor</b>	3.0 MP CMOS 1/3"
<b>View angle</b>	170°
<b>Video resolution</b>	1920x1080 (30 fps), 1280x720 (60 fps), 1280x720 (30 fps), 640x480 (30 fps)
<b>Video codec</b>	MP4 (H.264)
<b>Picture format</b>	JPEG
<b>Memory</b>	up to 32GB (microSD Class 6 or above, SDHC/SDXC)
<b>Microphone</b>	Built-in
<b>Motion Detection</b>	Yes
<b>Power source</b>	Built-in battery, car charger
<b>Interfaces</b>	HDMI, mini USB
<b>Operating temperature</b>	0 °C ~ 45°C
<b>Dimension</b>	43.8 x 85.5 x 34.7 mm (H x W x D)
<b>Weight</b>	64 g