

Description

Main body:

Aluminium extrusion, alloy AlMg Si 0.5 with integral grooves for circuit cards.

Lid:

Aluminium casting or aluminium sheet as required. All cast lids have a gasket and meet protection classification IP 65.

Type of seal:

Self-adhesive flat gasket in NBR (Perbunan) with high chemical resistance.

Front plates:

Aluminium bezel lid with self-adhesive anodized aluminium sheet front plate, 0.8 mm in thickness. Aluminium cast lid for membranes, with anodized front plate in aluminium 2 mm thick.

Attachment of enclosure:

Through rear wall in cast or flat aluminium.

Paint:

Synthetic stoved profile in silver, RAL 9006. Lid in black, RAL 9005.

Special colours on request.

Transparent cover:

Transparent cover for bezel lid in PVC, with milled fastener, or to lock, as required, to protection classification IP 65.

Special versions:

Sea-water resistant paint with corrosion-proof chromate coating (SBGL) for strongly corrosive environments on request. HF version with electrically conductive special seal to afford protection against electromagnetic interference, on request.

Special dimensions:

The enclosure profiles are of variable lengths and can also be supplied in small numbers at short notice in special lengths. (Please give length required when ordering).

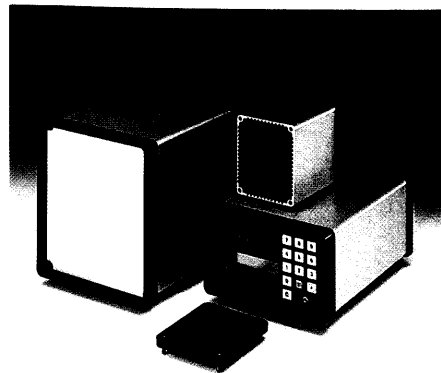

Technical Data

Protection classification	IP 65 or IP 40 to DIN 40050, depending on the lid
Temperature range	-40° to +100° C lid gasket -40° to + 50° C transparent cover in PVC with moss rubber gasket -40° to + 80° C transparent cover in polycarbonate with PUR foam seal

Construction

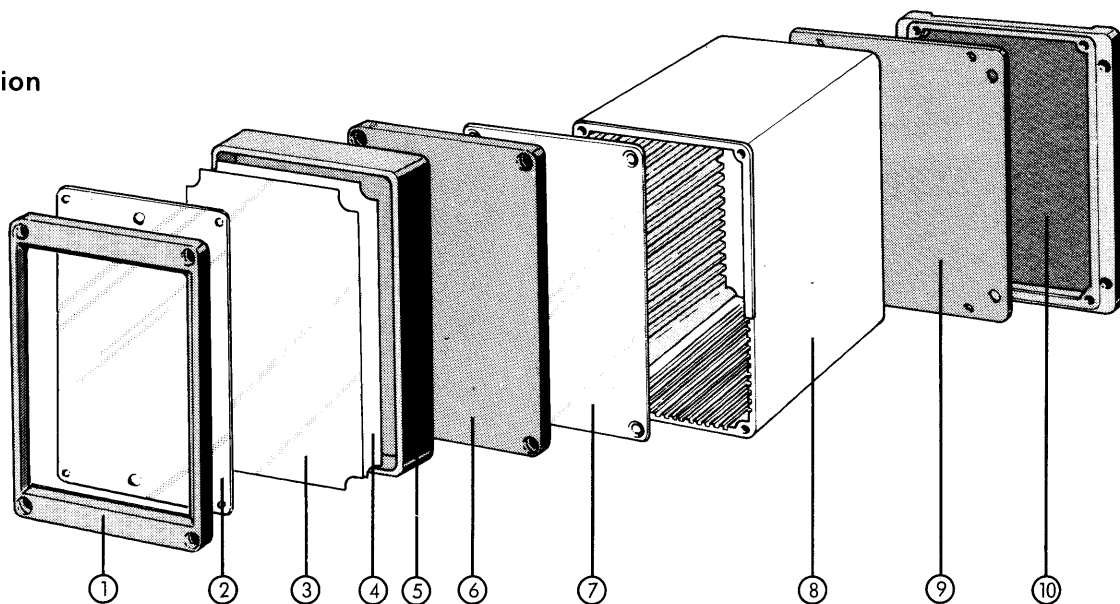

- | | |
|-----------------------------------|------------------------|
| 1. Membrane lid | 6. Cast lid |
| 2. Front plate for membrane lid | 7. Flat lid |
| 3. Front plate for protective lid | 8. Body |
| 4. Foil | 9. Mounting wall |
| 5. Protective lid | 10. Cast mounting wall |

Choice of Enclosure

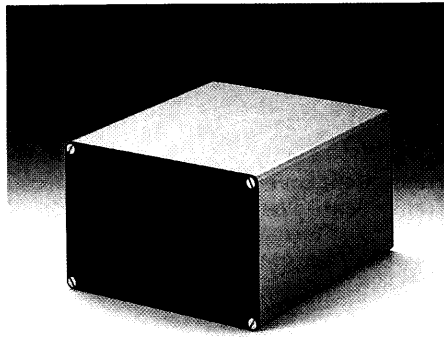

Version with two aluminium flat lids

Protection classification IP 40

Type	Order No.	Weight (g)
07.05	07.05 20 12	570
07.06	07.06 20 18	1100
07.07	07.07 20 18	1750

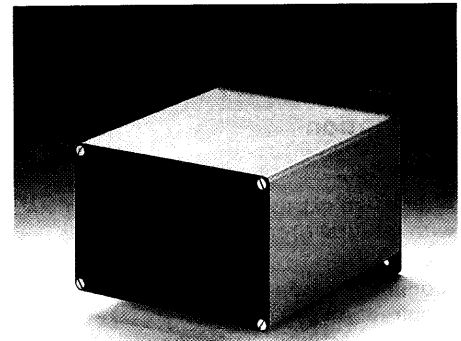

Version with one aluminium flat lid and one flat aluminium rear wall mounting

Protection classification IP 40

Type	Order No.	Weight (g)
07.05	07.05 21 12	590
07.06	07.06 21 18	1160
07.07	07.07 21 18	1850

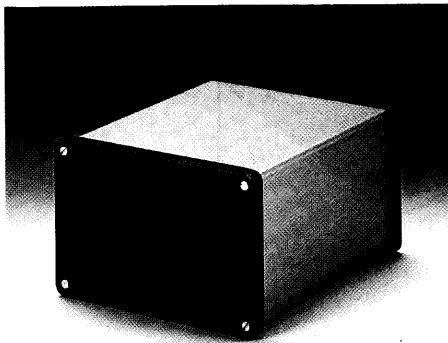

Version with two aluminium cast lids

Protection classification IP 65

Type	Order No.	Weight (g)
07.05	07.05 22 12	650
07.06	07.06 22 18	1300
07.07	07.07 22 18	2100

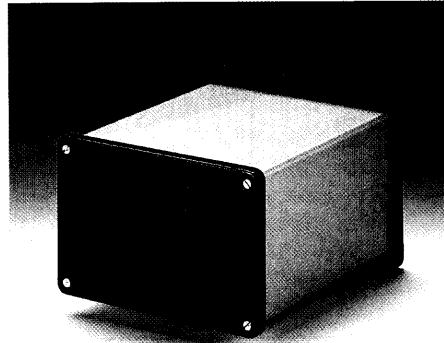

Version with one aluminium cast lid and one cast aluminium rear wall mounting

Protection classification IP 65

Type	Order No.	Weight (g)
07.05	07.05 23 12	685
07.06	07.06 23 18	1360
07.07	07.07 23 18	2250

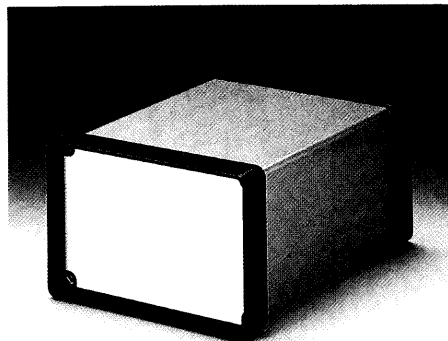

Version with two aluminium bezel lids

Protection classification IP 65

Type	Order No.	Weight (g)
07.05	07.05 24 12	785
07.06	07.06 24 18	1460
07.07	07.07 24 18	2300

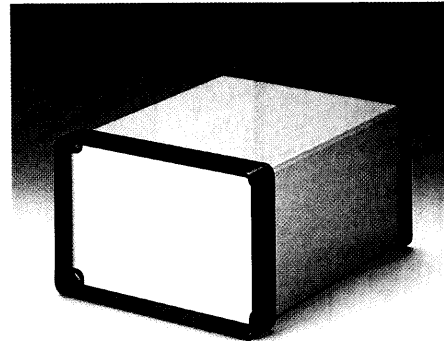

Version with one aluminium cast bezel lid and one aluminium cast lid

Protection classification IP 65

Type	Order No.	Weight (g)
07.05	07.05 25 12	720
07.06	07.06 25 18	1380
07.07	07.07 25 18	2200

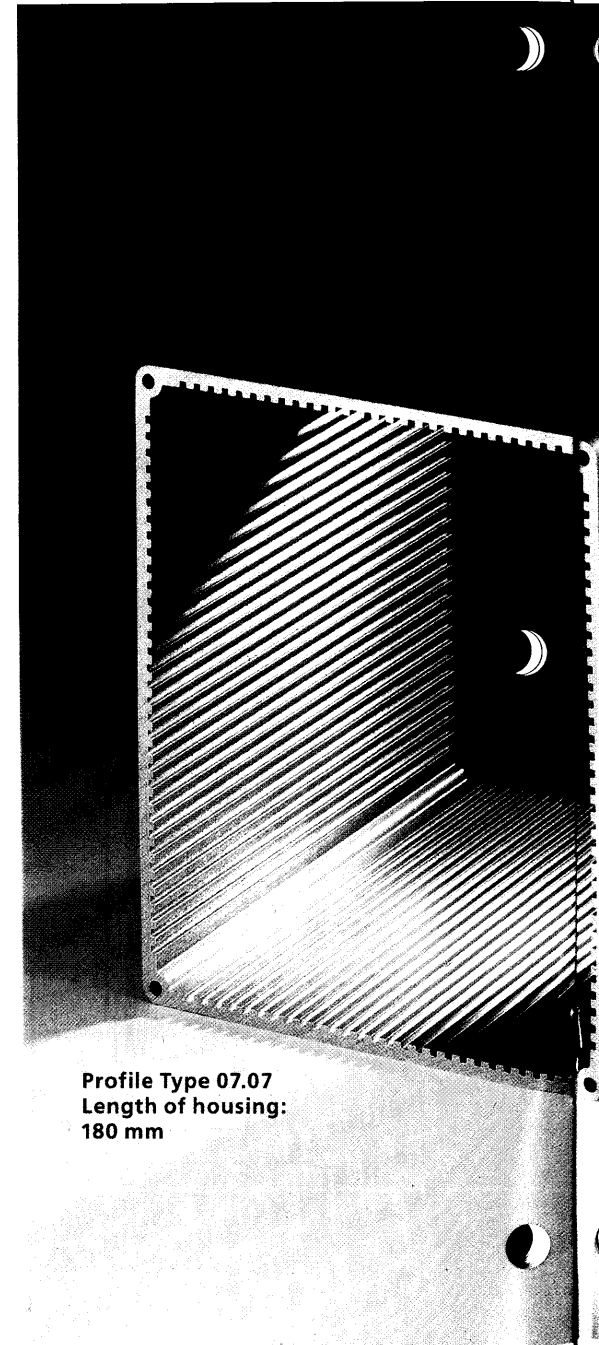

Profile Type 07.07
Length of housing:
180 mm

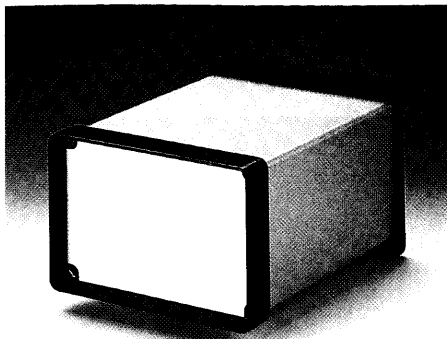

Version with one cast aluminium bezel lid and one cast aluminium rear wall mounting

Protection classification IP 65

Type	Order No.	Weight (g)
07.05	07.05 26 12	755
07.06	07.06 26 18	1440
07.07	07.07 26 18	2270

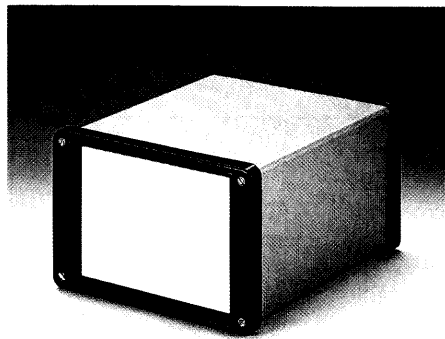

Version with one cast aluminium membrane lid and one aluminium cast lid

Protection classification IP 65

Type	Order No.	Weight (g)
07.06	07.06 27 18	1372
07.07	07.07 27 18	2192

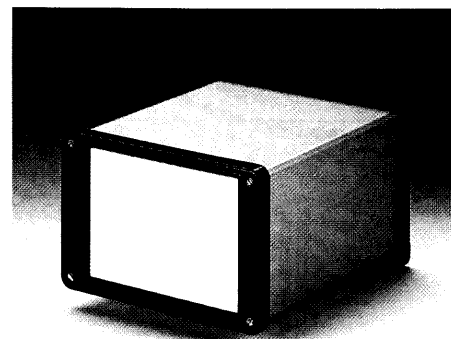

Version with one cast aluminium membrane lid and one cast aluminium rear wall mounting

Protection classification IP 65

Type	Order No.	Weight (g)
07.06	07.06 28 18	1432
07.07	07.07 28 18	2262

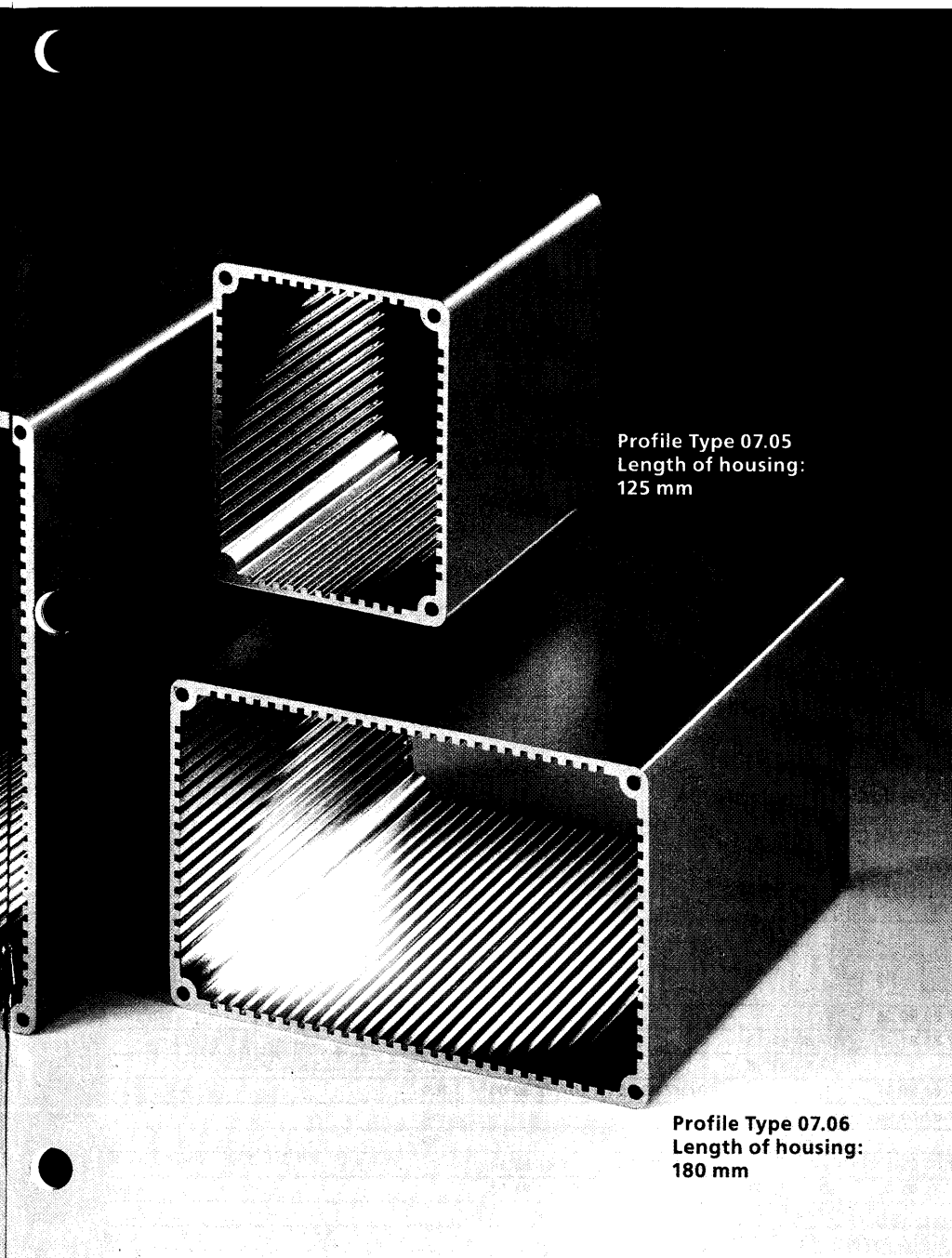

Profile Type 07.05
Length of housing:
125 mm

Profile Type 07.06
Length of housing:
180 mm

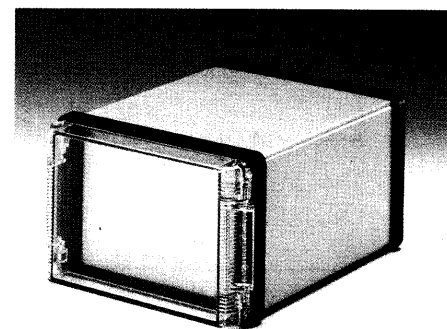

Version with one cast aluminium membrane lid, transparent cover and one aluminium cast lid

Protection classification IP 65

Type	Order No.	Weight (g)
07.06	07.06 29 18	1380
07.07	07.07 29 18	2200

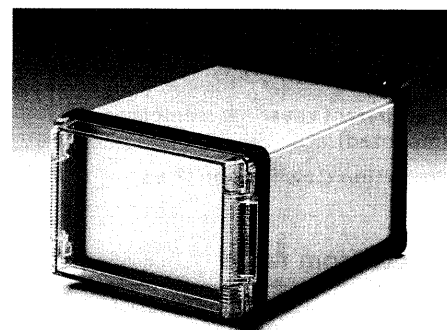

Version with one cast aluminium membrane lid, transparent cover and one cast aluminium rear wall mounting

Protection classification IP 65

Type	Order No.	Weight (g)
07.06	07.06 30 18	1440
07.07	07.07 30 18	2270

Accessories

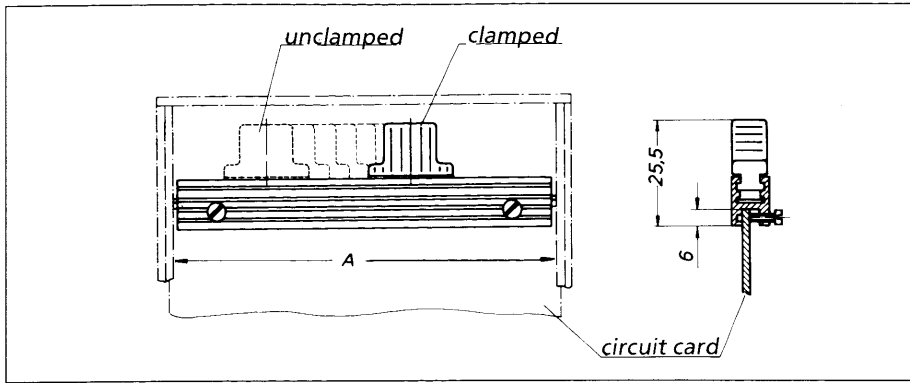

Card holder (KH) to position cards at any housing depth required and prevent vibration.

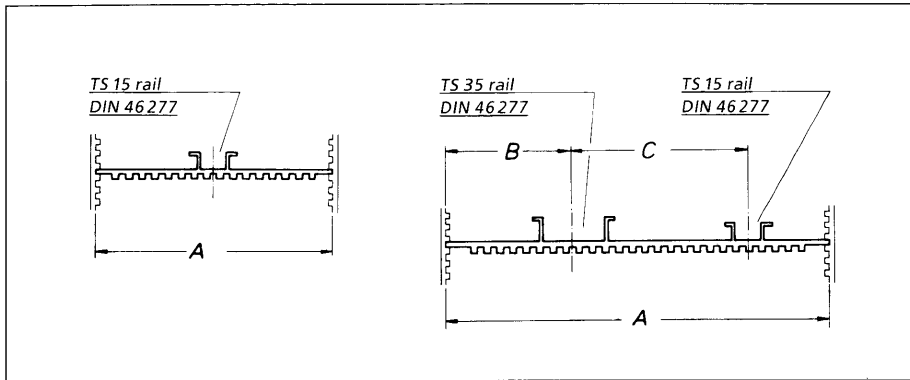
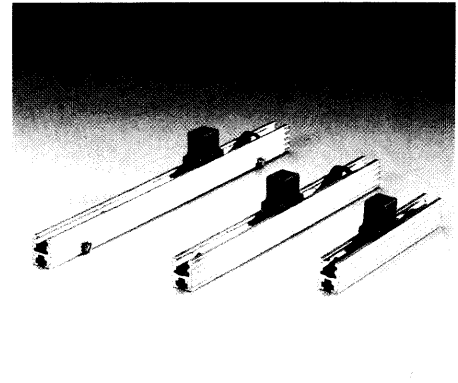

Adapter (AD) to divide the interior at variable points into two or more functional compartments. Clips for terminals, relays, etc. Non-standardised card formats can be fitted. Aluminium extrusion.

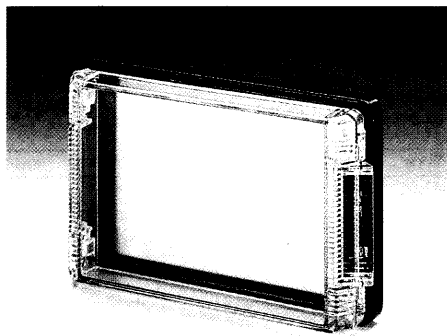
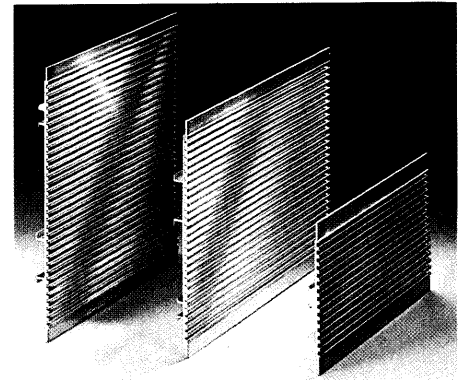

Transparent cover for membrane lid (mounted)

Protection classification IP 65

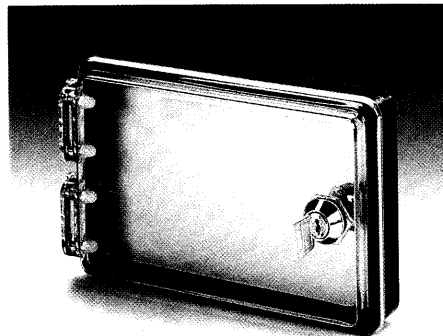

Transparent cover for protective lid (mounted)

Protection classification IP 54

Transparent cover for membrane lid

Type	Order No.
07.09	07.80 80 03 5

Transparent cover for protective lid

Type	Order No.
07.06	07.80 80 01 5 milled fastener
07.06	07.80 80 02 5 to lock
07.09	07.80 80 01 5 milled fastener
07.09	07.80 80 02 5 to lock

Select from table

Type		0705	0706	0707	0708	0709	Dimensions		
Profile							A	B	C
Adapter	H 100 mm	07.80 80 12	07.80 80 18	-	-	-	100	-	-
Adapter	H 160 mm	-	07.80 81 18	07.80 81 18	-	-	160	55	73
Adapter	H 189,5 mm	-	-	07.80 82 18	-	-	189,5	55	73
Card holder	H 100 mm	07.82 80 00	07.82 80 00	-	07.82 80 00	07.82 80 00	100	-	-
Card holder	H 160 mm	-	07.82 81 00	07.82 81 00	-	-	160	-	-
Card holder	H 189,5 mm	-	-	07.82 82 00	-	-	189,5	-	-
Clamping system*	H 100 mm	07.81 80 06	07.81 80 14	-	07.81 80 06	07.81 80 14	-	-	-
Clamping system*	H 160 mm	-	07.81 81 08	07.81 81 17	-	07.81 81 08	-	-	-
Clamping system*	H 189,5 mm	-	-	07.81 82 14	-	-	-	-	-

* Clamping system to position connectors according to DIN 41612, 41617 or 41620 at any housing depth required and prevent vibration.

Dimensions

Profile Type 07.05 / L = 125 mm

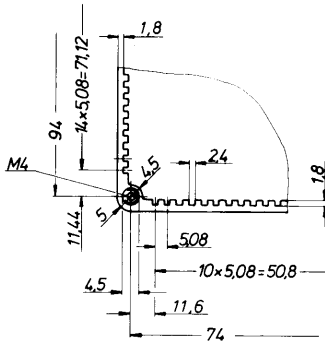
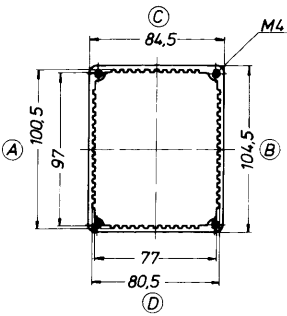

Profile Type 07.06 / L = 180 mm

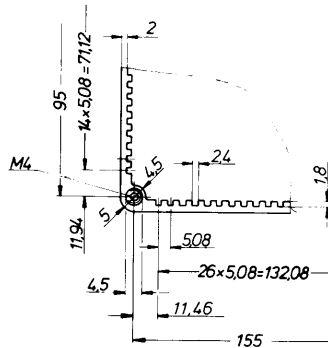
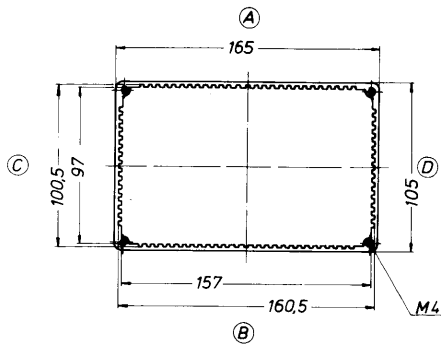

Profile Type 07.07 / L = 180 mm

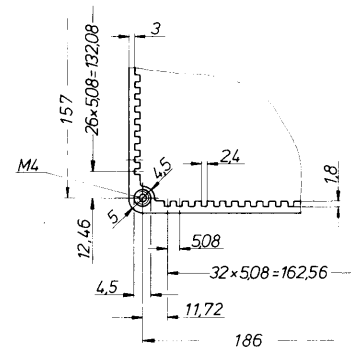
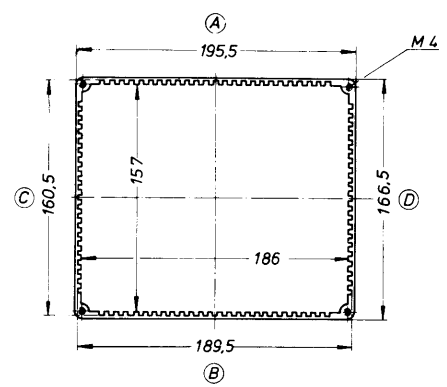

Front plate for membrane lid Type 07.07

Front plate for membrane lid Type 07.06

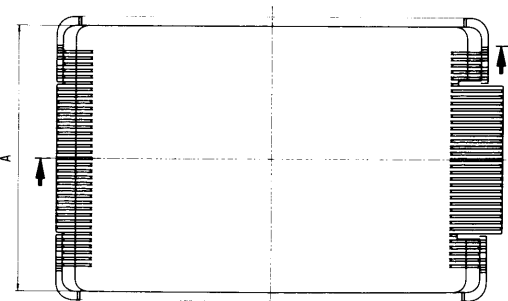
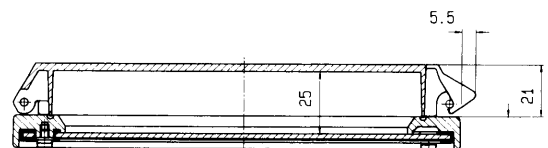
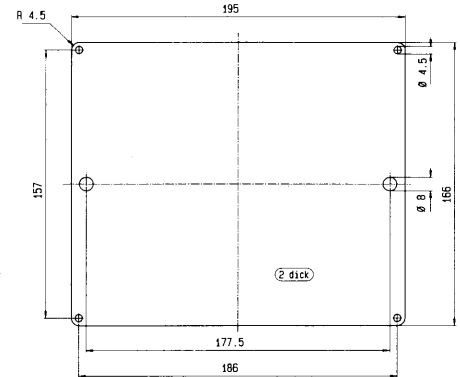
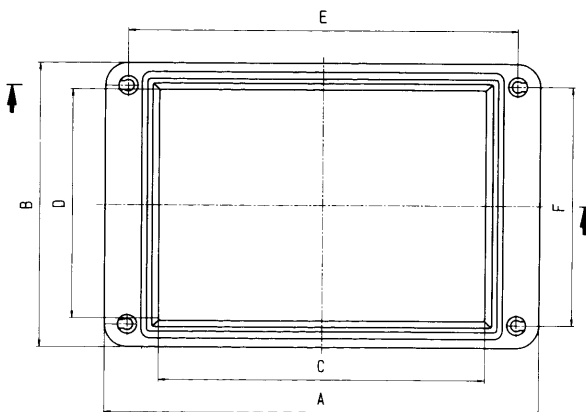
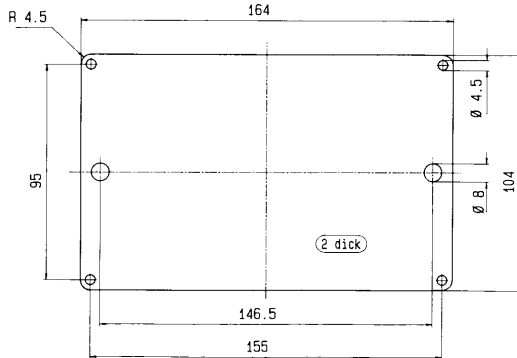

Aluminium cast membrane lid

Type	A	B	C	D	E	F	G	H
07.06	173	113	130	92	155	95	-	-
07.07	204	175	161	154	186	157	-	-

Transparent cover for membrane lid

Type	A	B	C	D	E	F	G	H
07.06	106	-	-	-	-	-	-	-
07.07	168	-	-	-	-	-	-	-

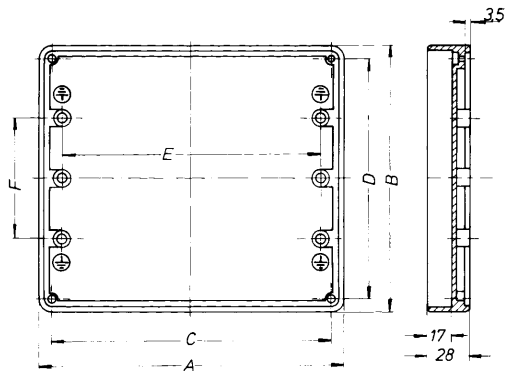

Aluminium cast bezel lid

Type	A	B	C	D	E	F	G	H
07.05	111,5	91,5	94	74	85	-	-	-
07.06	172	112	155	95	145	-	-	-
07.07	203	174	186	157	174	80	-	-

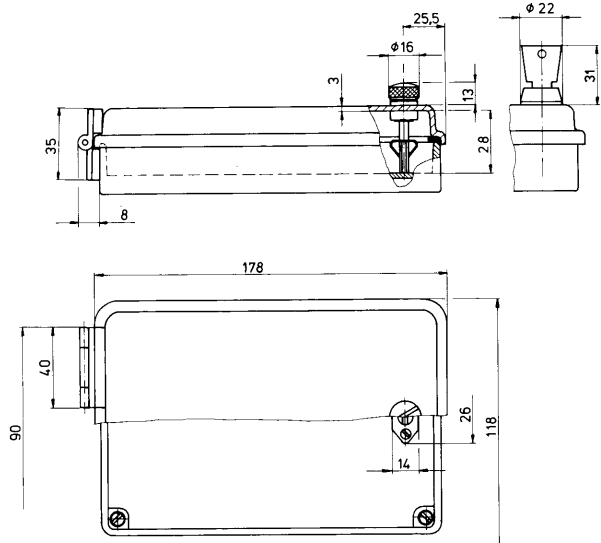

Transparent cover for cast aluminium bezel lid

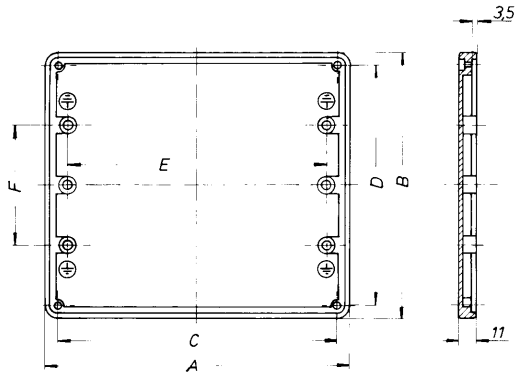

Aluminium cast lid

Type	A	B	C	D	E	F	G	H
07.05	111,5	91,5	94	74	85	-	-	-
07.06	172	112	155	95	145	-	-	-
07.07	203	174	186	157	174	80	-	-

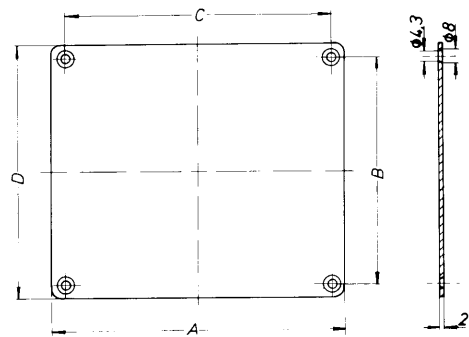

Aluminium flat lid

Type	A	B	C	D	E	F	G	H
07.05	104	74	94	84	-	-	-	-
07.06	165	95	155	105	-	-	-	-
07.07	196	157	186	167	-	-	-	-

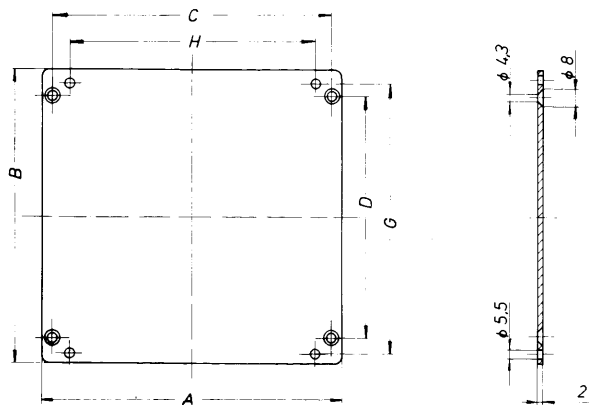

Flat aluminium rear wall mounting

Type	A	B	C	D	E	F	G	H
07.05	105	112	94	74	-	-	-	-
07.06	165	135	155	95	-	-	-	-
07.07	196	196	186	157	-	-	-	-

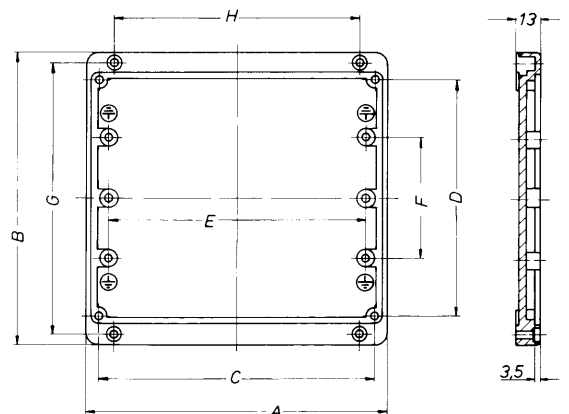

Cast aluminium rear wall mounting

Type	A	B	C	D	E	F	G	H
07.05	111	112	94	74	85	-	100	85
07.06	172	135	155	95	145	-	120	140
07.07	203	196	186	157	174	80	182	165