



PCB terminal block; 6 mm²; Pin spacing 7.5 mm; 2-pole; Push-in CAGE CLAMP®

Item No.: 2626-1102/020-000



PCB terminal block; 6 mm²; Pin spacing 7.5 mm; 2-pole; Push-in CAGE CLAMP®

Marking

RoHS ✓
Compliant

Business data

Supplier	WAGO
Item no.	2626-1102/020-000
GTIN / EAN	4055143587075
Content	1
Order amount	140
Customer item number	

Notes

Item description: PCB terminal blocks with Push-in CAGE CLAMP® connection Push-in termination of solid and ferruled conductors Ideal for panel feedthrough applications via operation parallel to conductor entry Testing can be performed both parallel and perpendicular to conductor entry

Technical data

Miscellaneous

Available upon request (depending on quantity required):	Other pole numbers
Packaging type	BOX
Ratings per	IEC/EN 60664-1

Technical data	
Rated voltage (III / 3) [V]	800 [V]
Rated impulse voltage (III / 3) [kV]	8 [kV]
Rated voltage (III/2) [V]	1000 [V]
Rated impulse voltage (III / 2) [kV]	8 [kV]
Rated voltage (II / 2) [V]	1000 [V]
Rated impulse voltage (II / 2) [kV]	8 [kV]
Rated current [A]	41 [A]
Legend (ratings)	(III / 2) Overvoltage category III / Pollution degree 2
No. of poles	2
Total number of connection points	2
Total number of potentials	2
Number of connection types	1
Number of levels	1
Connection technology	Push-in CAGE CLAMP®
Actuation type	Operating tool
Solid conductor	0.2 ... 10 mm ² / 24 ... 8 AWG
Fine-stranded conductor	0.2 ... 10 mm ² / 24 ... 8 AWG
Fine-stranded conductor with ferrule with plastic collar	0.25 ... 6 mm ²
Fine-stranded conductor with ferrule without plastic collar	0.25 ... 6 mm ² / ...
Strip length	13 ... 15 mm / 0.51 ... 0.59 Inch
Pin spacing	7.5 mm (0.295 in)
Width	16.8 mm / 0.661 Inch
Height	23.6 mm / 0.929 Inch
Height from the surface	19.6 mm / 0.772 Inch
Depth	24.2 mm / 0.953 Inch
Solder pin length [mm]	4 [mm]
Solder pin dimensions	1.5 x 1 mm
Drilled hole diameter (tolerance) [mm]	2(+ 0.1) [mm]
Type of mounting	Feed-through mounting
PCB contact	THT
Solder pin arrangement	over the entire terminal strip, staggered
Number of solder pins per potential	1
Color	gray
Material group	I

Technical data	
<i>Insulating material</i>	<i>Polyamide 66 (PA 66)</i>
<i>Flammability class per UL94</i>	<i>V0</i>
<i>Clamping spring material</i>	<i>Chrome nickel spring steel (CrNi)</i>
<i>Contact material</i>	<i>Electrolytic copper (Ecu)</i>
<i>Contact plating</i>	<i>tin-plated</i>
<i>Weight [g]</i>	<i>8.288 [g]</i>
<i>Limit temperature range</i>	<i>-60 ... 105 °C</i>
<i>Pin spacing from [mm]</i>	<i>7.5 [mm]</i>
<i>Main product function</i>	<i>PCB terminal block</i>
<i>Product type</i>	<i>PCB terminal blocks</i>

Images & drawings





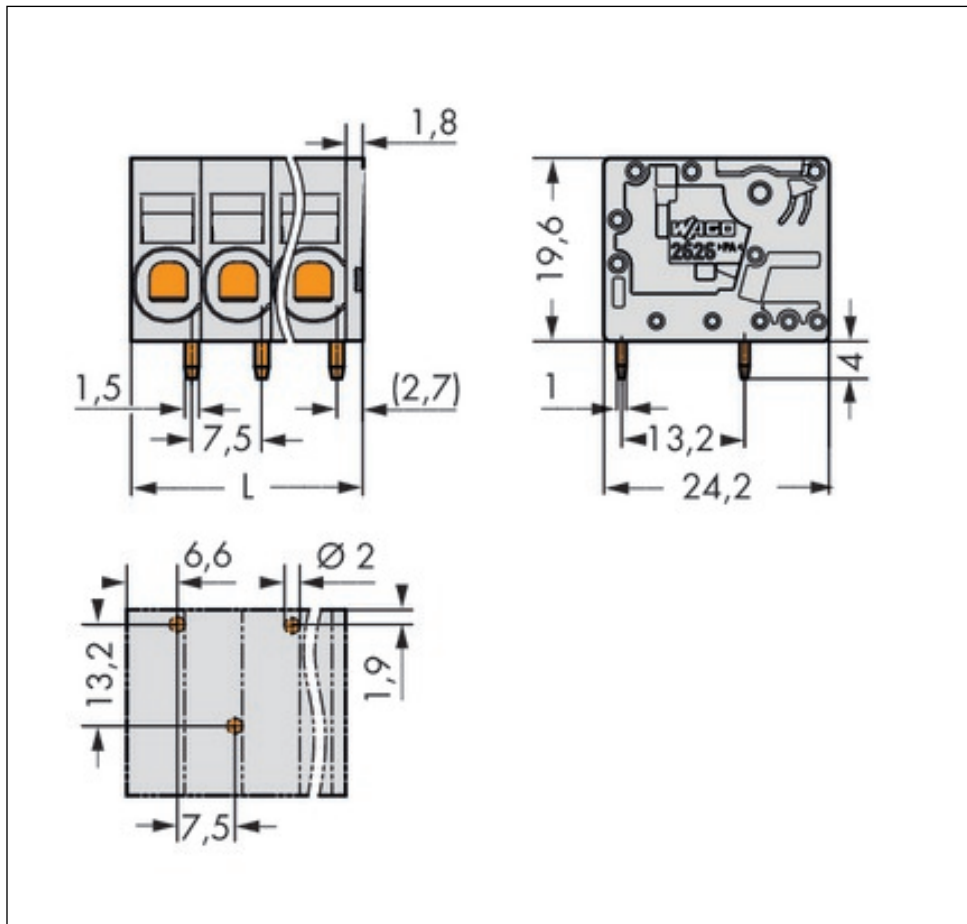

Address

WAGO Kontakttechnik GmbH & Co. KG

Hansastr. 27

32423 Minden

Telefon: 0571/887-0

Fax: 0571/887-169

<http://www.wago.com>

© WAGO Kontakttechnik GmbH & Co. KG

Technische Änderungen und Irrtümer vorbehalten.