

PAGE 1/3	ISSUE 22-08-17B	SERIES NEX10	PART NUMBER R180052017
----------	-----------------	--------------	------------------------

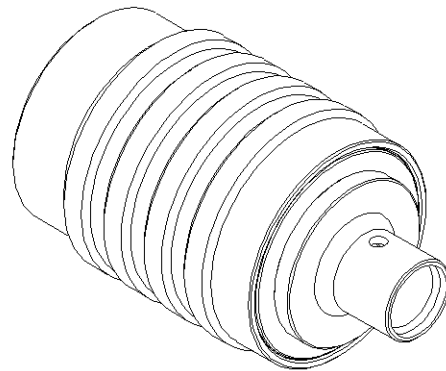

All dimensions are in mm. Tolerances according ISO 2768 m-H

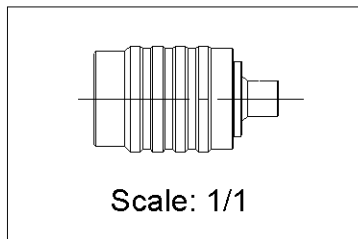
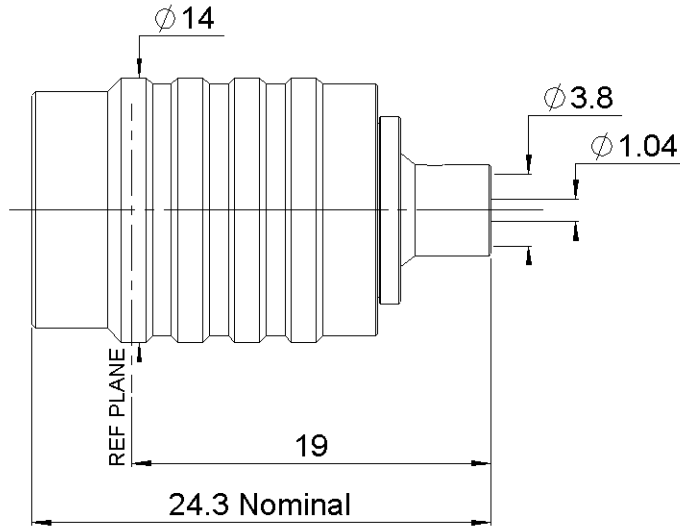
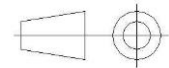

COMPONENTS	MATERIALS	PLATING (μm)
Body	BRASS.	BBR
Center contact	BRASS.	SILVER
Outer contact	BERYLLIUM COPPER	SILVER
Insulator	PTFE	
Gasket	SILICONE RUBBER	
Others parts	BRASS,STAINLESS STEEL	BBR
-	-	-
-	-	-

PAGE 2/3	ISSUE 22-08-17B	SERIES NEX10	PART NUMBER R180052017
-----------------	------------------------	---------------------	-------------------------------

PACKAGING

Standard	Unit	Other
50	Contact us	Contact us

ELECTRICAL CHARACTERISTICS

Impedance	50	Ω
Frequency	0-20	GHz
VSWR	1.02 + 0.0150	x F(GHz) Maxi
Insertion loss	0.05	\sqrt{F} (GHz) dB Maxi
RF leakage	- (NA)	- F(GHz)) dB Maxi
Voltage rating	500	Veff Maxi
Dielectric withstanding voltage	1500	Veff mini
Insulation resistance	5000	M Ω mini

MECHANICAL CHARACTERISTICS

Center contact retention		
Axial force – Mating End	NA	N mini
Axial force – Opposite end	NA	N mini
Torque	NA	N.cm mini
Recommended torque		
Mating	NA	N.cm
Panel nut	NA	N.cm
Clamp nut	NA	N.cm
A/F clamp nut	0.0000	mm
Mating life	100	Cycles mini
Weight	12.8440	g

ENVIRONMENTAL

Operating temperature	-55~+125	$^{\circ}\text{C}$
Hermetic seal	NA	Atm.cm3/s
Panel leakage	NA	

SPECIFICATION

CABLE ASSEMBLY

Stripping	a	b	c	d	e	f
mm	3.2	0	0	0	0.85	0

Assembly instruction: **NA**

Recommended cable(s)

RG 402

Characteristics indicated on this data sheet are those that can be achieved with the highest performance cable. Intrinsic limitations of the cable may diminish the performance of the assembly

Cable retention

- pull off	200	N mini
- torque	NA	N.cm

TOOLING

Part Number	Description	Hexagon
.	.	.

OTHER CHARACTERISTICS

IP68(1m,24h) mated condition
PIM3<=-123 dBm, 2 carriers of +43dBm

PAGE 3/3	ISSUE 22-08-17B	SERIES NEX10	PART NUMBER R180052017
----------	-----------------	--------------	------------------------

COMPONENTS

BODY

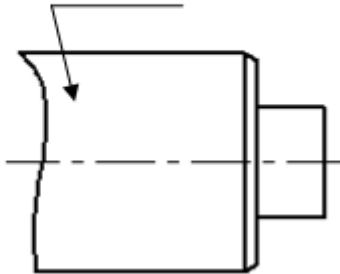

CENTER CONTACT

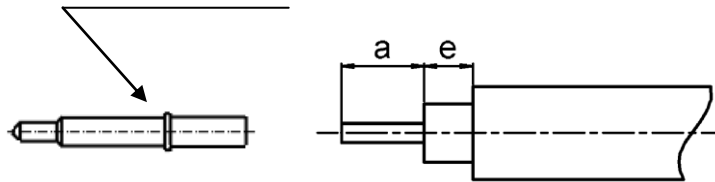

1

- Strip the cable with the cable stripping tool.
- Clean the cable

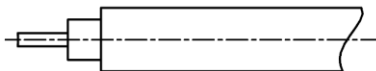

3

- Introduce the cable into the body until contact with the body shoulder.
- Place the sub-assembly on assembly jig
- Solder body on the cable.
- Let assembly cool down before removing it from the jig.

2

- Insert center contact until the cable
- Solder center contact

