

ATLAS SERIES

Warm White LED Light Engine (Preliminary)

Lamina Light Engine

As the market leader in the development and manufacture of super-bright LED light engines, Lamina brings solid state lighting to applications which until now were possible only with traditional lighting sources.

Lamina's LED light engines are manufactured by combining high brightness LEDs from industry-leading LED manufacturers with Lamina's proprietary packaging technology. This technology is a breakthrough in thermal performance for LED packaging, a key factor in determining LED life and reliability. Unmatched thermal performance coupled with package interconnectivity allows Lamina to densely cluster multiple LEDs to achieve exceptionally high luminous intensity in very small footprints. Lamina's light engines are available in white, RGB and monochrome, from 1W to 100W, and also in custom packages up to 1000W.

Lamina LED Light Engines provide:

- HIGH LUMINOUS FLUX IN SMALL FOOTPRINT
- SUPERIOR THERMAL PERFORMANCE FOR IMPROVED RELIABILITY
- LONG LIFE AND HIGH LUMEN MAINTENANCE
- SUSTAINABLE DESIGN – ROHS COMPLIANT¹
- CUSTOM SIZES AND SHAPES AVAILABLE

ATLAS Warm White

Lamina's newest addition to the award winning Atlas series delivers up to 162 lumens in True White (3000°K) from a single point. Enhanced red and orange color spectrum and a CRI of 80 make this product ideal for incandescent and halogen replacements. The LED light engines are configured with a single cavity populated with multiple LEDs. The new design incorporates many new features, including:

- ROUND FOOTPRINT FOR DESIGN FLEXIBILITY
- DESIGNED FOR POPULAR DRIVE CURRENTS – 700mA – 1050mA
- LAMINA NARROW, MEDIUM AND WIDE OPTICS AVAILABLE
- ISOLATED METAL BASE – MAKES WIRING IN SERIES OR PARALLEL POSSIBLE ON A COMMON HEAT SINK
- INTEGRATED ESD PROTECTION – 2,000V HBM
- AVAILABLE MOUNTED TO LAMINA'S EZCONNECT BOARD FOR SOLDERLESS CONNECTIONS
- LAMINA HEAT SINKS AND DEVELOPER KITS AVAILABLE FOR RAPID PROTOTYPING

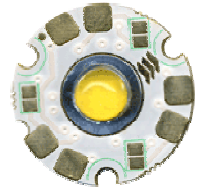

TYPICAL APPLICATIONS

ARCHITECTURAL LIGHTING

- DECORATIVE AND ACCENT
- COVE AND UNDER-SHELF
- GARDEN AND PATHWAY
- STEP LIGHTS

MACHINE VISION

DISPLAY BACKLIGHTING

FIBER OPTIC ILLUMINATION

TASK LIGHTING

- DESK LAMPS
- FLASHLIGHTS

MEDICAL

AUTOMOTIVE

AIRCRAFT

SIGNALS

SECURITY LIGHTING

1. ALL LAMINA LIGHT ENGINES ARE ROHS COMPLIANT. LAMINA IS CONVERTING LAMINA ACCESSORIES AND DEVELOPER KITS TO BE ROHS COMPLIANT WELL IN ADVANCE OF THE 1 JULY 2006 DEADLINE.

To see how you can realize all these design benefits, to request a sample, or to speak with an engineer about your design, contact Lamina at 800.808.5822 or 609.265.1401 or visit www.laminaceramics.com.

Technical Data					
P/N NT-42D1-0425	Symbol	@ 700mA constant current drive, correlated to T _J 25 °C			Unit
		Min	Typical	Max	
Color Temperature ¹	CCT	-	3050	-	°K
Color Rendering Index	CRI	70	80	-	
Thermal Resistance	T _R	-	4	5.5	°C/W
Insulation Resistance ²	-	1	-	-	MΩ
Electrical Isolation ³	-	100	-	-	V
LED Junction Temperature ⁴	T _J	-	-	125	°C
Storage Temperature	-	-	-	-	°C
Assembly Temperature	-	-	-	-	°C
ESD Sensitivity	HBM	-	-	4000	V

1. CCT can is supplied on binned product.
2. Isolation resistance between any terminal and base.
3. Electrical isolation voltage between any terminal and base.
4. Lower junction temperatures improve lumen maintenance.

Technical Data						
P/N NT-42D1-0425	Symbol	700mA		1050mA		Unit
		Min	Typical	Min	Typical	
Voltage*	V _F		7.5		8.2	V
Test Current	I _F		700		1050	mA
Power*	P		5.27		8.61	W
Luminous Flux*	Φ _V		120	135	162	lm

*Optical and electrical specifications are given for the specified drive current at a 25°C junction temperature.

Light Output Characteristics

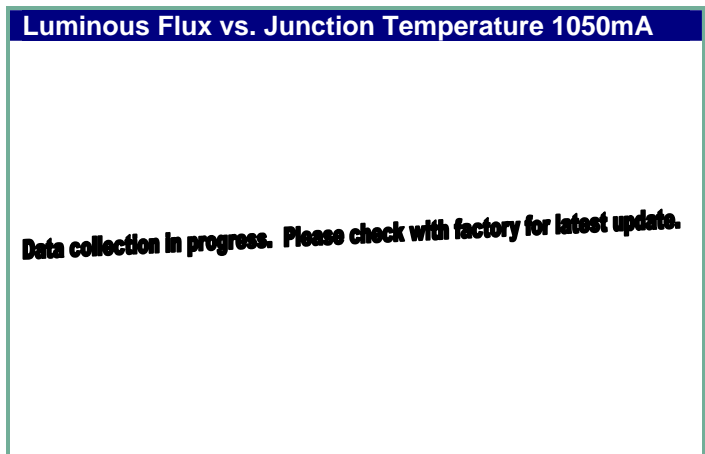
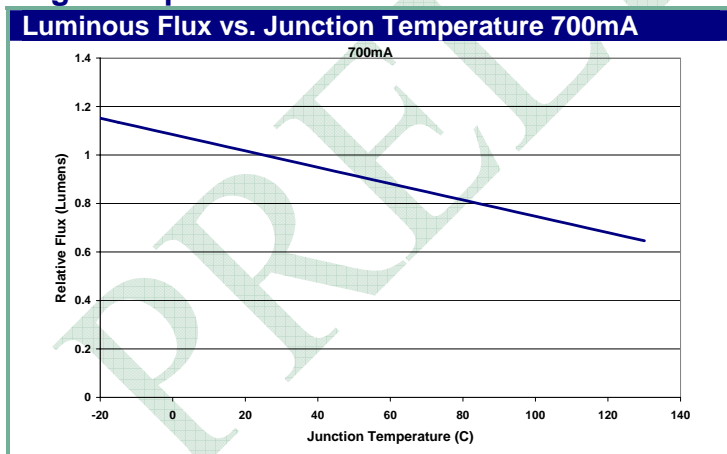

Luminous Flux vs. Junction Temperature

Light output from LED die will decrease with increasing junction temperature. As a result it is recommended that the LED engine's heat sink design be optimized to maintain the die junction temperature as low as possible.

To see how you can realize all these design benefits, to request a sample, or to speak with an engineer about your design, contact Lamina at 800.808.5822 or 609.265.1401 or visit www.laminaceramics.com.

Luminous Flux vs. Current

When operating at drive currents higher than test currents indicated here, do not exceed maximum recommended junction temperature. Higher drive currents increase luminous flux but also increase the thermal load. Without proper heat sinking, lower efficacy (lumens per watt) and lower lumen maintenance may result. For dimming significantly below test currents indicated, pulse width modulation is recommended for maximum consistency and stability of light properties.

Typical Beam Pattern

Lamina's Atlas LED light engines project a 125° (2θ1/2, 50% of peak value) Lambertian radiation pattern. Narrower beam distributions can be produced by use of selected popular LED optics. Please contact Lamina Application Engineering for support with your optical needs.

Typical Beam Pattern (optics available)

Data collection in progress. Please check with factory for latest update.

Spectral Power Distribution

Data collection in progress. Please check with factory for latest update.

Forward Current vs. Forward Voltage

Data collection in progress. Please check with factory for latest update.

Max Current vs. Pulse Conditions

Data collection in progress. Please check with factory for latest update.

To see how you can realize all these design benefits, to request a sample, or to speak with an engineer about your design, contact Lamina at 800.808.5822 or 609.265.1401 or visit www.laminaceramics.com.

Projected Lumen Maintenance

Data collection in progress. Please check with factory for latest update.

Relative Flux vs Current / Efficacy vs Current

Data collection in progress. Please check with factory for latest update.

Connections

The Atlas LED light engines are available with or without Lamina's EZConnect board. EZConnect adapter boards have AMP connectors for solderless connections to Lamina's mating wiring harness.

Lamina's Atlas light engines are configured with large solder pads compatible with Sn63 or Sn62 or lead free solder (220°C max) solder. As with many electrical devices, non-acid RMA type solder flux should be used to prepare the solder pads before application of solder. Ensure proper strain relief of wires attached to the light engine to prevent damage to the light engines solder pads. For more information refer to Lamina's Connection application note which can be found on the website www.LaminaCeramics.com.

Mechanical and Electrical Specifications

ATLAS 3000K White, P/N NT-42D1-0425

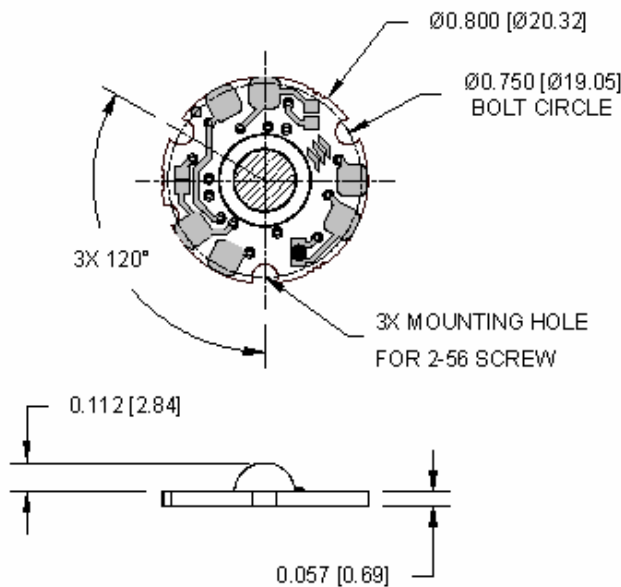

All dimensions in inches [mm].

ATLAS 3000K White, P/N NT-42D1-0425

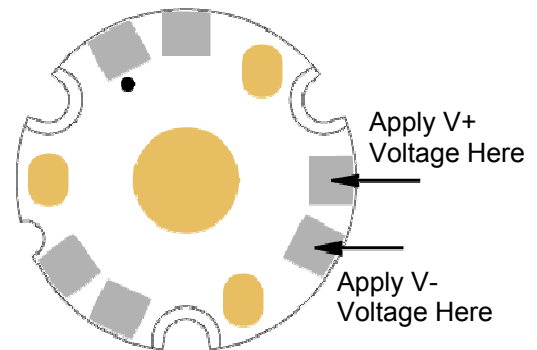

To see how you can realize all these design benefits, to request a sample, or to speak with an engineer about your design, contact Lamina at 800.808.5822 or 609.265.1401 or visit www.laminaceramics.com.

ATLAS attached to EZ-Connect EZ-42D1-0432

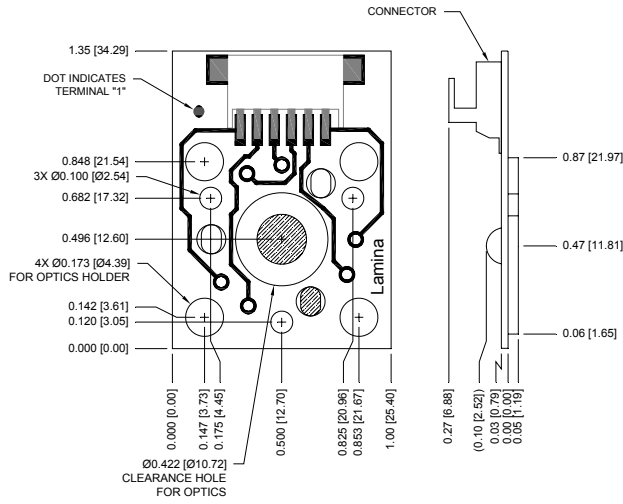

All dimensions in inches [mm].
Mating AMP connector 173977-6

ATLAS EZ-Connect Wiring harness EZ-46WH-0354

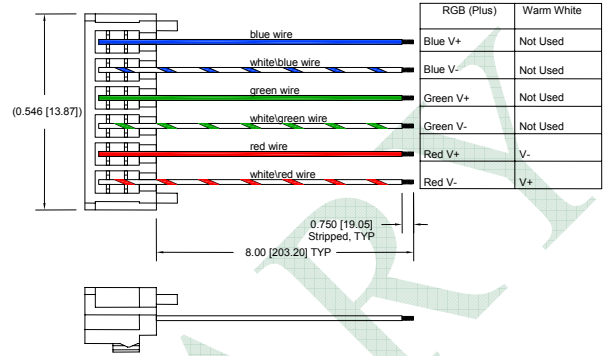

All dimensions in inches [mm].
Mating AMP connector 3-292173-6

Driving Lamina Light Engines

Lamina's Atlas light engines are designed to operate under current controlled conditions, either constant current, PWM or other current control methods. The Atlas family is designed to operate using commercially available driver sources from many electronic power supply companies. Lamina's Application Engineering team can assist with the proper selection of drivers and can assist with guidance on your own drive current design.

Assembly Recommendations

Lamina's Atlas Series Light Engines are designed for attachment to a heat sink with conductive epoxy (Arctic Silver Thermal Adhesive or equivalent), or screw down for flange mount devices with thermal grease (Wakefield Thermal Solutions 120 Series Silicone Oil-Based Joint Compound or equivalent) in the joint. For attachment using screws, a 2-56 UNC round head or metric equivalent M2 X 0.4 cheese head screw, 18-8 SS is recommended. When mounting the light engine, position the three screws in the center of each of the three slots. Tighten the three screws evenly, first to about 0.89 inch pounds (10 Newton-centimeter), and then tighten each to a maximum torque of 4 inch pounds (45 Newton-centimeter). Flatness requirement of the surface that the light engine is mounted to is 0.001 inch/inch (1mm/meter). Thermal tape is not recommended for attachment to heat sinks. When using conductive epoxy to attach to heat sinks, do not use screws as damage to light source may result.

Heat Sink Recommendations

Lamina LED light engines provide efficient transfer of heat from the individual LED die to a customer supplied heat sink. Lamina's Atlas light engines must be operated at or below 125°C die junction temperature. A heat sink must be attached to the engine with sufficient cooling capacity to keep the die junction below 125°C. The temperature rise from the engine base to the die junction may be determined by calculating the product of the maximum package thermal resistance and the desired operating power level:

$$\text{Junction Temperature Rise (T}_j \text{ (rise))} = \text{Operating Power (P)} \times (\text{Lamina Array Thermal Resistance})$$

The appropriate heat sink may then be approximated* by:

$$\text{Heat Sink Thermal Resistance (}^\circ\text{C/W)} = (125^\circ\text{C} - \text{T}_j \text{ (rise)} - \text{Maximum Ambient Temperature}) / \text{P}$$

*Approximation assumes light engines are screwed down and thermal grease is used as thermal interface material.

Lamina has developed a selection of radial heat sinks for rapid prototyping of designs with Lamina's LED Light Engines. Lamina's heat sinks are available through select distributors. More information on Lamina's heat sinks and distributors is available on our website.

To see how you can realize all these design benefits, to request a sample, or to speak with an engineer about your design, contact Lamina at 800.808.5822 or 609.265.1401 or visit www.laminaceramics.com.

Optics

Lamina now offers optics with narrow, medium and wide beam distributions designed for the Atlas product family. Lamina, working with Fraen Corporation, has developed optics and optic holders based on Fraen's popular FHS series. Atlas optics are designed to produce homogeneous beam distributions with high collection efficiencies. The optic holders are designed to attach to Lamina's EZConnect board.

Handling Precaution

Contact with the silicone based encapsulant on the surface of the light engine must be avoided to prevent damage. Do not apply pressure to the silicone based encapsulant or allow it to come into contact with sharp objects. Lamina LED engines must be handled from the sides.

Please visit Lamina's website, LaminaCeramics.com, for more information on Lamina's LED light engines and Lamina's worldwide distribution network.

Lamina Ceramics
120 Hancock Lane
Westampton, NJ USA 08060

Specifications subject to change without notice • ©2006 Lamina Ceramics, Inc.

To see how you can realize all these design benefits, to request a sample, or to speak with an engineer about your design, contact Lamina at 800.808.5822 or 609.265.1401 or visit www.laminaceramics.com.