

NUMBER GS-12-220	TYPE PRODUCT SPECIFICATION		
TITLE 2mm High Power Connector System		PAGE 1 of 15	REVISION H
		AUTHORIZED BY Tan Chen Hong	DATE 21 Dec 08
CLASSIFICATION UNRESTRICTED			

1.0 OBJECTIVE

This specification defines the performance, test, quality and reliability requirements for the 2mm High Power Connector System.

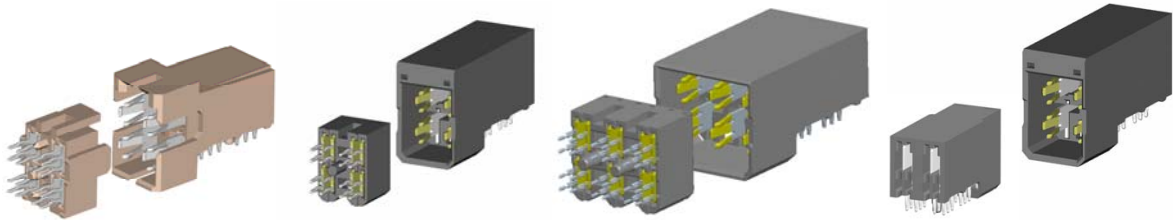

Figure 1: 2mm High Power Connector System,

Metral® High Power Configuration

AirMax® Power Configuration

2.0 SCOPE

This specification is applicable to the termination characteristics of the 2mm High Power Connector System which provides a separable power interface for daughter card applications. The 2mm High Power Connector system includes Metral® High Power and AirMax® Power product versions, in both leaded and lead-free platings.

2.1 Connector Configurations

Product Version	Header Contact Configurations			Receptacle Contact Configurations	
Metral® High Power Version (FutureBus)	2 X 2 (Fig. 2)		1 X 2 (Fig. 3)	2 X 2 (Fig. 4)	
AirMax® Power Version (Hard Metric)	2 X 2 (Fig. 5)	2 X 3 (Fig. 8)	1 X 2 (Fig. 6)	2 X 2 (Fig. 7 & 10)	2 x 3 (Fig. 9)

- 2mm High Power receptacles are offered in a vertical 2x2 configuration which mates to either header type.
- Only AirMax® Power vertical receptacles and right angle header are offered in 2x3 configurations. It adopts one additional column similar to a 2x2 right angle header/vertical receptacle.
- Only 2x2 AirMax® Power is offered in a coplanar mating configuration; right angle receptacle mates to either header types (1x2 or 2x2).
- Each of the two 1x2 header contacts have 7 press-fit tails while each of the four 2x2 header contacts has 3 press-fit tails. See applicable figures.

NUMBER GS-12-220	TYPE PRODUCT SPECIFICATION		
TITLE 2mm High Power Connector System		PAGE 2 of 15	REVISION H
		AUTHORIZED BY Tan Chen Hong	DATE 21 Dec 08
CLASSIFICATION UNRESTRICTED			

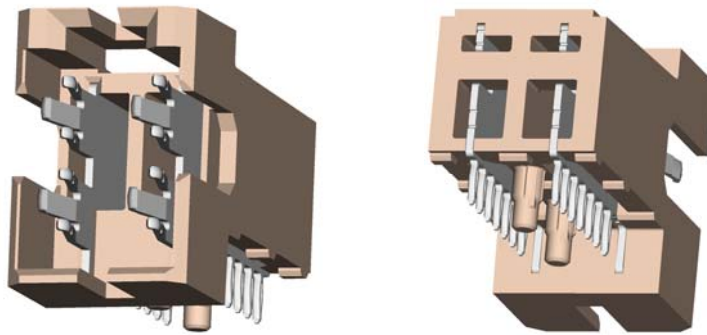

Figure 2: Metral® High Power 1x2 Header

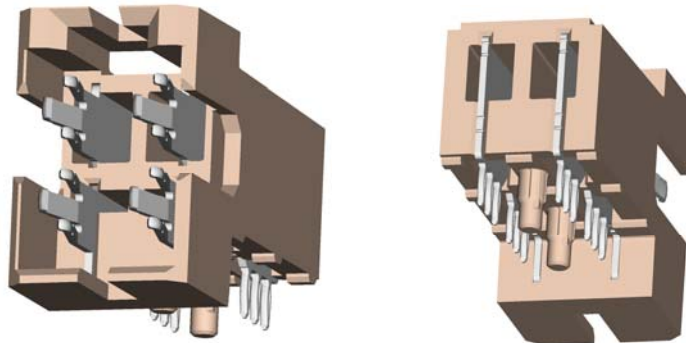

Figure 3: Metral® High Power 2x2 Header

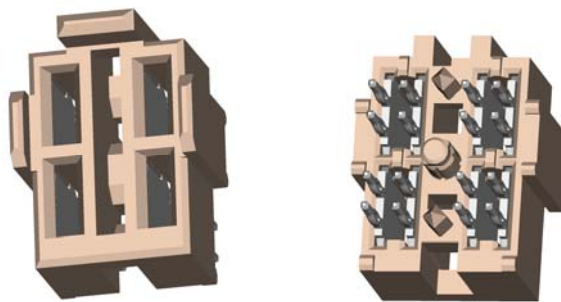



Figure 4: Metral® High Power Receptacle

NUMBER GS-12-220	TYPE PRODUCT SPECIFICATION		
TITLE 2mm High Power Connector System		PAGE 3 of 15	REVISION H
		AUTHORIZED BY Tan Chen Hong	DATE 21 Dec 08
CLASSIFICATION UNRESTRICTED			

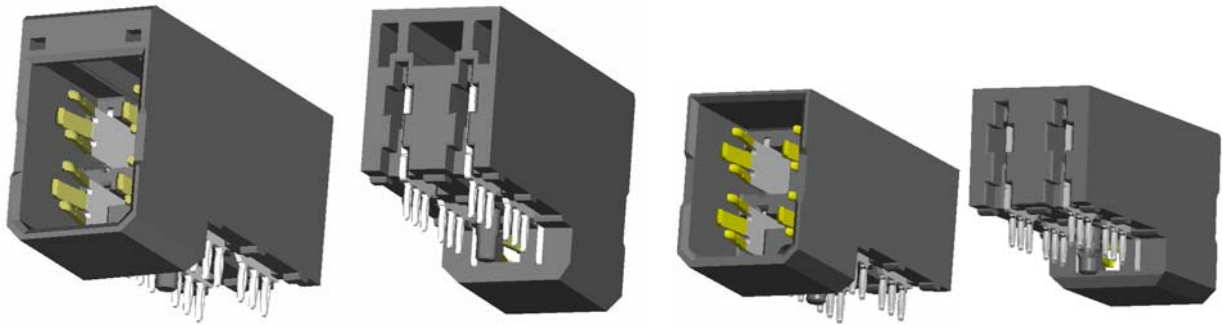

Figure 5: AirMax[®] Power 2x2 Header

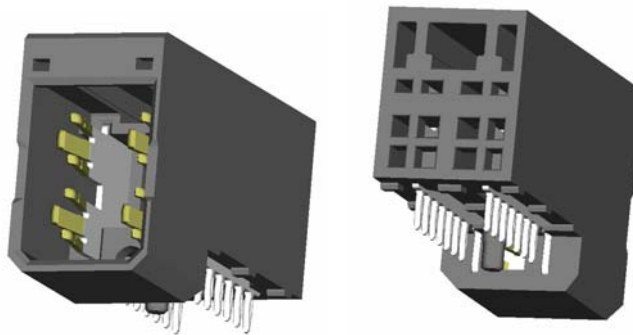

Figure 6: AirMax[®] Power 1x2 Header

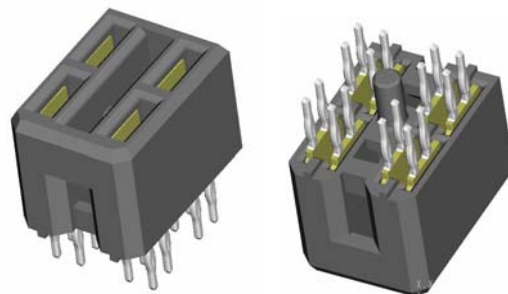



Figure 7: AirMax[®] Power Vertical 2x2 Receptacle

NUMBER GS-12-220	TYPE PRODUCT SPECIFICATION		
TITLE 2mm High Power Connector System		PAGE 4 of 15	REVISION H
		AUTHORIZED BY Tan Chen Hong	DATE 21 Dec 08
CLASSIFICATION UNRESTRICTED			

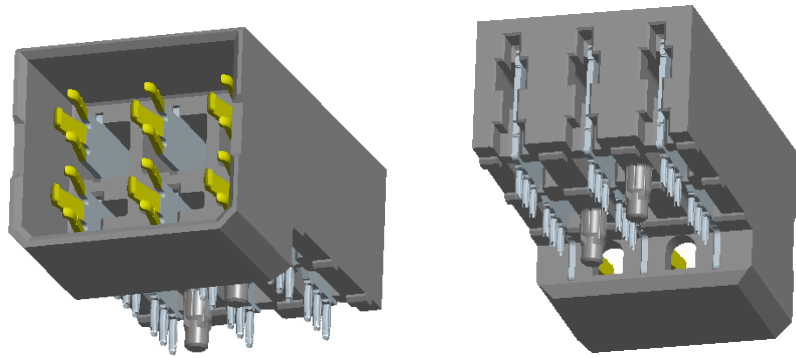

Figure 8: AirMax® Power 2x3 Header

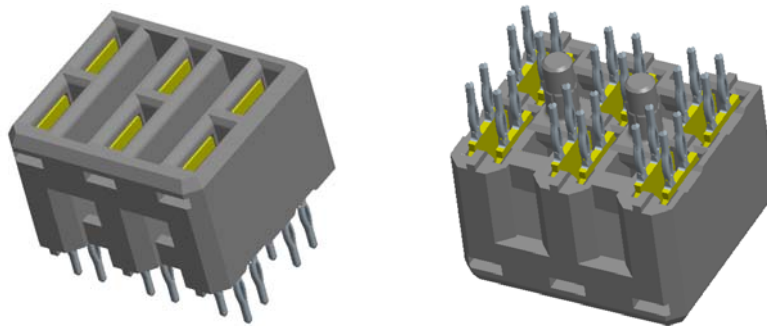

Figure 9: AirMax® Power Vertical 2x3 Receptacle

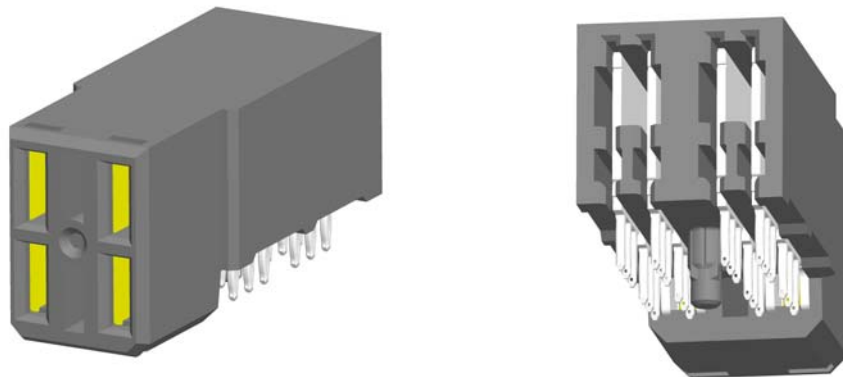



Figure 10: AirMax® Power R/A 2x2 Receptacle

NUMBER GS-12-220	TYPE PRODUCT SPECIFICATION		
TITLE 2mm High Power Connector System		PAGE 5 of 15	REVISION H
		AUTHORIZED BY Tan Chen Hong	DATE 21 Dec 08
		CLASSIFICATION UNRESTRICTED	

3.0 GENERAL

This document is composed of the following sections:

<u>Paragraph</u>	<u>Title</u>	<u>Page</u>
1.0.....	OBJECTIVE.....	1
2.0.....	SCOPE.....	1
2.1	Connector Configurations	1
3.0.....	GENERAL.....	5
4.0.....	APPLICABLE DOCUMENTS.....	6
5.0.....	REQUIREMENTS.....	6
5.1	Ratings and Test Boards	
5.2	Materials	
5.3	Qualification	
5.4	Design and construction	
5.5	Visual	
6.0.....	ELECTRICAL CHARACTERISTICS.....	8
7.0.....	MECHANICAL CHARACTERISTICS.....	9
8.0.....	ENVIRONMENTAL CONDITIONS.....	11
9.0.....	QUALITY ASSURANCE PROVISIONS.....	13
9.1	Equipment Calibration	
9.2	Inspection Conditions	
9.3	Sample Quality and Description	
9.4	Acceptance	
9.5	Qualification Testing	
9.6	Re-qualification Testing	
	Table 1: Qualification Test Matrix.....	14
	REVISION RECORD.....	15

NUMBER GS-12-220	TYPE PRODUCT SPECIFICATION		
TITLE 2mm High Power Connector System		PAGE 6 of 15	REVISION H
		AUTHORIZED BY Tan Chen Hong	DATE 21 Dec 08
CLASSIFICATION UNRESTRICTED			

4.0 APPLICABLE DOCUMENTS

4.1 FCI Specifications:

Applicable FCI product drawings
 BUS-03-404: Normal Force Measurement
 BUS-03-601: Current Rating/30⁰C Temperature Rise
 GS-20-023: Application Specification, 2mm High Power Connector System
 GS-20-001: Attachment Specification for Metral Connectors (press peg specification)

4.2 Other Standards and Specifications

IEC 664-1: Insulation Coordination for Equipment with Low-Voltage Systems
 IEC 61984: Connectors - Safety Requirements and Tests
 UL 60950 (supercedes UL 1950): Safety of Information Technology Equipment
 IEC 60950-1*: Information Technology Equipment – Safety, Part 1: General Requirements
 UL94-V0: Tests for Flammability of Plastic Materials in Devices and Appliances
 GR-1217-CORE: Telcordia Specification “ Generic Requirements for Separable Electrical Connectors”
 EIA 364: Electrical Connector/Socket Test Procedures Including Environmental Classifications

* IEC 60950-1 contains the same information as UL 60950

4.5 FCI Lab Reports - Supporting Data

EL 2002-10-039 (Qualification Test Report, Metral™ High Power)
 EL 2004-04-003 (Re-Qualification Test Report, AirMax™ Power)
 EL 2007-07-043 (Re-Qualification Test Report, AirMax™ Power, 2x3)

5.0 REQUIREMENTS

5.1 Ratings and Test Boards

Maximum operating temperature: 105⁰ C

Maximum voltage between adjacent lines: 150 VDC (1.6mm minimum creepage & clearance distance in secondary circuits per IEC 664-1, IEC 61984, and UL 60950)

Following are the current rating values for the 2mm High Power connector system in various mated test configurations:

Right Angle Application				
Receptacle type	Number of columns fully powered	Copper Pad Weight	Max Current Per Contact	
			Mated to a 1x2 R/A Header	Mated to a 2x2 / 2x3 R/A Header
Vertical Receptacle	2	5 oz	40A	20A
	Up to 10 adjacent	5 oz	32A	14A
	2	2 oz	32A	15A
	Up to 10 adjacent	2 oz	27A	12A

NUMBER GS-12-220	TYPE PRODUCT SPECIFICATION		
TITLE 2mm High Power Connector System		PAGE 7 of 15	REVISION H
		AUTHORIZED BY Tan Chen Hong	DATE 21 Dec 08
CLASSIFICATION UNRESTRICTED			

Coplanar Application				
Receptacle type	Number of columns fully powered	Copper Pad Weight	Max Current Per Contact	
			Mated to a 1x2 R/A Header	Mated to a 2x2 R/A Header
Right Angle Receptacle	2	2 oz	37A	18A
	Up to 10 adjacent	2 oz	29A	14A

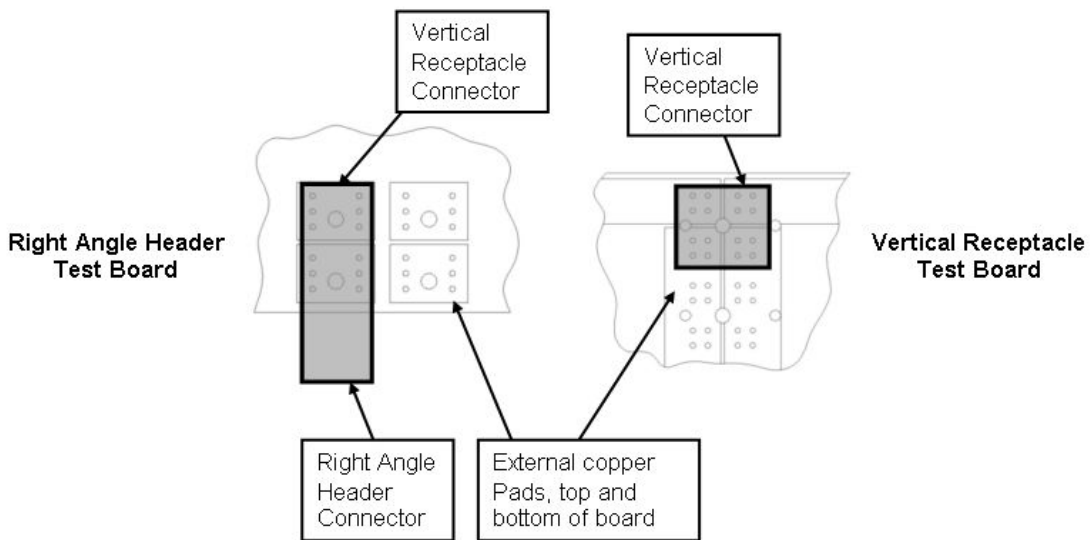

Figure 11:
Copper Pad Sizes Relative to Connector Modules (2x2 version shown):
Copper pads isolated under connector modules, top and bottom of PCB

5.2 Materials

The material for each component shall be as specified herein or equivalent:

Contacts: High performance copper alloy, performance-based plating over nickel in mating areas

Press-fit tails: Tin-lead over nickel (Leaded) or Tin over nickel (Lead-free)

Housings: High temperature thermoplastic, UL 94V-0 compliant

5.3 Qualification

Connectors furnished under this specification shall be capable of meeting the qualification test requirements specified herein.

5.4 Design and Construction

Connectors shall be of the design, construction and physical dimensions specified on the applicable product drawings.

NUMBER GS-12-220	TYPE PRODUCT SPECIFICATION		
TITLE 2mm High Power Connector System		PAGE 8 of 15	REVISION H
		AUTHORIZED BY Tan Chen Hong	DATE 21 Dec 08
CLASSIFICATION UNRESTRICTED			

5.5 Visual

Visual examinations shall be performed using 10X magnification. Parts should be free from blistering, cracks, discoloration, etc.

6.0 ELECTRICAL CHARACTERISTICS

6.1 Contact Resistance at Specified Current: (30 readings for top contacts & 30 readings for bottom contacts)

The contact resistance at a specified current shall not exceed 1.0 mΩ initially or after mating cycles and environmental exposure when measured in accordance with EIA 364-06. The test current is 15 Amps.

6.2 Insulation Resistance: (20 readings between top & bottom contacts)

The insulation resistance of mated connectors shall not be less than 10,000 MΩ for contacts, initially and after environmental exposure when measured in accordance with EIA 364-21. The following details apply:

- a) Test voltage: 500 volts DC
- b) Electrification time: 2 minutes
- c) Points of measurement: between adjacent contacts

6.3 Dielectric Withstanding Voltage: (20 readings between top & bottom contacts)

There shall be no evidence of arc-over, insulation breakdown, or excessive leakage current (specified as >1 mA) when mated connectors are tested in accordance with EIA 364-20. The following details apply:

- a) Test voltage: 1500 volts AC, 60 Hz
- b) Test duration: 60 seconds
- c) Test condition: 1 atm
- d) Points of measurement: between adjacent contacts (top & bottom)

6.4 Current Rating (2 adjacent columns of contacts fully powered): Six temperature vs. applied current curves for upper contacts and 6 curves for lower contacts. Develop curves using a minimum of 5 current levels. Stop each test when the coolest thermocouple reaches 30 degrees temperature-rise.

The following details shall apply:

- a) Ambient conditions: still air at 25° C
- b) Reference: FCI Test Specification BUS-03-601
- c) Thermocouple location (must be attached to the contact near the base of the mating beams)
- d) Copper pad weight: 2 oz or 5 oz as noted
Header: Dual external pads of noted weight, approx. size of connector outline.
Receptacle: Dual external pads of noted weight, approx. size of connector outline.
- e) Feed wire size: 8 gauge

Current rating requirements as noted in paragraph 5.1

NUMBER GS-12-220	TYPE PRODUCT SPECIFICATION		
TITLE 2mm High Power Connector System		PAGE 9 of 15	REVISION H
		AUTHORIZED BY Tan Chen Hong	DATE 21 Dec 08
		CLASSIFICATION UNRESTRICTED	

6.5 Current De-rating : 10 adjacent columns of contacts (on 6mm centers) fully powered. Temperature vs. applied current curves for upper and lower contacts of 2 center-most columns. Develop curves using a minimum of 5 current levels. Stop each test when the coolest thermocouple reaches 30 degrees temperature rise.

The following details shall apply:

- a) Ambient conditions: still air at 25^o C
- b) Reference: FCI Test Specification BUS-03-601
- c) Thermocouple location (must be attached to the contact near the base of the mating beams)
- d) Copper trace weight: 2 oz or 5 oz as noted
 - Header: Dual external pads of noted weight, approx. size of connector outline.
 - Recept: Dual external pads of noted weight, approx. size of connector outline.
- e) Feed wire size: 8 gauge

Current de-rating requirements as noted in paragraph 5.1

7.0 MECHANICAL CHARACTERISTICS

7.1 Mating/Unmating Force:

Mating / Un-mating Force Per Connector Module		
Module Width	Maximum Mating Force	Minimum Un-mating Force
12mm	33.4 N (7.5 lbs)	9.0 N (2.0 lbs)
18mm	50 N (11.25 lbs)	13.5 N (3.0 lbs)

2x2 / 1x2 Module (12mm width) - (3 test board sets, 5 mated modules per board)
 2x3 Module (18mm width) - (3 test board sets, 3 mated modules per board)

Reference EIA 364-13. The following details shall apply:

- a) Cross head speed: 1 inch per minute
- b) Lubrication: None
- c) Utilize free-floating fixtures

7.2 Contact Normal Force: (8 loose piece contacts, 8 avg readings total for small beams, 8 for large beams)

For measurements prior to temperature life exposure, loose piece header contacts must be inserted into a receptacle once to account for any permanent set. They must also be inserted into a receptacle for the duration of the temperature-life exposure.

To measure normal force, the contact is laid flat with the two small beams resting on a flat surface. The large beam is deflected to a shut-height equal to the distance between receptacle contact mating surfaces, or 1.54mm. Cross-head speed is to be 0.2 inch/min and chart speed is to be 20 inch/min unless otherwise noted.

The measured contact normal force shall not be less than 4.90 N (500 grams). Reference FCI Test Specification BUS-03-404 as applicable.

NUMBER GS-12-220	TYPE PRODUCT SPECIFICATION		
TITLE 2mm High Power Connector System		PAGE 10 of 15	REVISION H
		AUTHORIZED BY Tan Chen Hong	DATE 21 Dec 08
		CLASSIFICATION UNRESTRICTED	

7.3 Compliant Pin Insertion Force, 3 Insertions: (45 loose receptacle contacts with 2 tails each)

Use boards with minimum diameter holes. The force required to insert an individual compliant pin into a plated through hole in a printed circuit board at a rate of 0.2 inches/minute shall not exceed 67 N (15 lb).

Insertion #1: 15 contacts; Record insertion forces based on average of two tails.

Insertion #2: 15 virgin contacts, same PCB holes; No data.

Insertion #3: 15 virgin contacts; same PCB holes; Record forces based on the average of two tails.

7.4 Compliant Pin Retention Force, 3 Extractions: (45 loose receptacle contacts with 2 tails each)

Use boards with maximum diameter holes. The retention force in the axial direction opposite that of insertion shall not be less than 17 N (3.8 lb) per press-fit tail.

Extraction #1: 15 contacts; Record insertion forces based on average of two tails.

Extraction #2: 15 virgin contacts, same PCB holes; No data.

Extraction #3: 15 virgin contacts, same PCB holes; Record forces based on the average of two tails.

** Extraction #3 occurs after Temperature Life (para. 8.3) **

7.5 PCB Hole Deformation Radius: (10 PCB holes)

Use boards with minimum diameter holes. Cross-section parallel to board surface. Photograph and measure the hole deformation (deformation on board material) radius at a point .010" from the surface, and the center of the compliant pin section. Include 10 holes. The average (of 10 holes) hole deformation radius shall be no greater than 0.0015" when measured from the drilled hole. The absolute maximum deformation radius shall not exceed 0.002". Photograph and measure the copper thickness remaining between the compliant section and the printed wiring board laminate. The minimum average (of 10 holes) copper thickness remaining shall not be less than 0.0003". Reference GR-1217-CORE, November 1995, Section 5.1.7.

7.6 PCB Hole Wall Damage: (10 PCB holes)

Use boards with minimum diameter holes. Cross-section perpendicular to the board surface, and through the compliant section wear track. There shall be no copper cracks, separations between conductive interfaces, or laminate-to-copper separations. Reference GR-1217-CORE, November 1995, Section 5.1.7.

NUMBER GS-12-220	TYPE PRODUCT SPECIFICATION		
TITLE 2mm High Power Connector System		PAGE 11 of 15	REVISION H
		AUTHORIZED BY Tan Chen Hong	DATE 21 Dec 08
CLASSIFICATION UNRESTRICTED			

8.0 ENVIRONMENTAL CONDITIONS

After exposure to the following environmental conditions in accordance with the specified test procedure and / or details, the product shall show no physical damage and shall meet the applicable electrical and mechanical requirements of sections 6.0 and 7.0 as detailed in Table 1. Unless otherwise specified, assemblies shall be mated during exposure.

8.1 Thermal Shock, per EIA 364-32, test condition II. The following details shall apply: (ref. Telcordia UE)

- a) Number of cycles: 5
- b) Temperature range: -65 to + 105⁰ C
- c) Time at each temperature: 30 minutes minimum
- d) Transfer time: 5 minutes maximum

8.2 Cyclical Humidity and Temperature: (ref. Telcordia CO)

Mated samples are to be exposed to cyclical humidity and temperature in accordance with EIA 364-31, Method IV. Samples are subjected to 50 humidity-temperature cycles of 10-hour duration for a total of 500 hours. Cyclical temperature extremes shall be +25°C and +65°C. A cycle consists of the following:

- a) 1 hour ramp from +25°C at 90-98%RH to +65°C at 90-98%RH
- b) 2 hour dwell at +65°C / 90-98%RH
- c) 1 hour ramp to +25°C / 80-98%RH
- d) 1 hour dwell at +25°C / 90-98%RH
- e) 1 hour ramp to +65°C / 90-98%RH
- f) 2 hour dwell at +65°C / 90-98%RH
- g) 1 hour ramp to +25°C / 80-98%RH
- h) 1 hour dwell at +25°C / 90-98%RH

8.3 Temperature Life: (ref. Telcordia UE)

EIA 364-17, Method A, Test Condition 4. Headers and receptacles shall remain mated w/o any electrical load. The following details shall apply:

- a) Test duration: 1000 hours
- b) Temperature: 105 +/- 2 °C

NUMBER GS-12-220	TYPE PRODUCT SPECIFICATION		
TITLE 2mm High Power Connector System		PAGE 12 of 15	REVISION H
		AUTHORIZED BY Tan Chen Hong	DATE 21 Dec 08
		CLASSIFICATION UNRESTRICTED	

8.4 Industrial Mixed Flowing Gas (4-gas MFG): (ref. Telcordia CO)

Samples are to be exposed to an industrial gas mixture in accordance with Telcordia GR-1217-CORE, November 1995, Section 9.1.3. The receptacles ONLY are to be exposed for 10 days to the gas mixture detailed below, with interim resistance measurements made after the 5th and 10th days. The samples are then mated with the appropriate header and exposed to an additional 10 days with resistance measurements taken after the 15th and 20th days of exposure. The test chamber is to be maintained at a temperature of 30±1°C with a relative humidity of 70±2%.

Per Central Office Requirement	
<u>Gas</u>	<u>Gas Concentration</u>
NO ₂	200 ppb
Cl ₂	10 ppb
H ₂ S	10 ppb
SO ₂	100 ppb

8.5 Vibration:

Perform in accordance with Telcordia GR-1217-CORE, November 1995. The following details shall apply:

- a) Vibration amplitude: 0.06 inch DA or 10G acceleration
- b) Frequency range: 10 to 500 Hz
- c) Duration: 8 hours along each of three orthogonal axes
- d) Mounting: Rigidly mount assemblies
- e) Requirement: No discontinuities greater than 10 nano-seconds

8.6 Mechanical Shock:

Perform in accordance with Telcordia GR-1217-CORE, November 1995, Sections 6.3.5 and 9.1.2.1. The following details shall apply:

- a) Conditions: half-sine 30G, 11 milli-second duration.
- b) Shocks: 3 shocks along each of three orthogonal axis
- c) Mounting: rigidly mounted assemblies

8.7 Durability:

Use standard laboratory procedure as applicable to the specific product.

- a) Number of cycles: see Table 1
- b) Cycling rate: 127 mm/minute (5 inches/minute)
- c) Mating and unmating force to be measured per Section 7.1 on the first and last cycle where specified in Qualification Test Matrix Table 1.

8.8 Dust Contamination:

Perform in accordance with Telcordia GR-1217-CORE, November 1995, Section 9.1.1.1 & Table 9-1, unmated receptacle connectors.

8.9 Disturb:

Back the fully seated header from the receptacle approximately 0.10 mm (0.004 in) and then re-seat.

NUMBER GS-12-220	TYPE PRODUCT SPECIFICATION		
TITLE 2mm High Power Connector System		PAGE 13 of 15	REVISION H
		AUTHORIZED BY Tan Chen Hong	DATE 21 Dec 08
CLASSIFICATION UNRESTRICTED			

9.0 QUALITY ASSURANCE PROVISIONS

9.1 Equipment Calibration:

All test equipment and inspection facilities used in the performance of any test shall be maintained in a calibration system in accordance with ISO 9000.

9.2 Inspection conditions:

Unless otherwise specified, all inspections shall be performed under the following conditions:

- a) Temperature: 25 +/- 5^o C
- b) Relative humidity: 30 to 60%
- c) Barometric Pressure: Local ambient

Sample Quantity and Description:

The sample size and description is listed for each test in the appropriate section of this document.

9.4 Acceptance:

Electrical and mechanical requirements placed on test samples as indicated in the sections of this specification shall be established from test data using appropriate statistical techniques or shall otherwise be customer specified, and all samples tested in accordance with the product specification shall meet the stated requirements.

Failures attributed to equipment, test set-up or operator error shall not disqualify the product. If product failure occurs, corrective action shall be taken and samples resubmitted for qualification.

9.5 Qualification Testing:

Qualification testing shall be performed on sample units with equipment and procedures normally used in production. Test sequence is as shown in Table 1.

9.6 Re-qualification Testing

If any of the following conditions occur, the responsible product engineer shall initiate re-qualification testing consisting of the applicable parts of the test matrix, Table 1.

- a) A significant design change is made to the existing product that impacts the product form, fit or function. Examples of significant changes shall include, but not be limited to, changes in the plating material composition or thickness, contact force or contact surface geometry, insulator design, contact base material or contact lubrication requirements.
- b) A significant event occurs during production or end use requiring corrective action to be taken relative to the product design or manufacturing process.
- c) A significant change is made to the manufacturing process that impacts the product form, fit or function.



NUMBER GS-12-220	TYPE PRODUCT SPECIFICATION		
TITLE 2mm High Power Connector System		PAGE 14 of 15	REVISION H
		AUTHORIZED BY Tan Chen Hong	DATE 21 Dec 08
CLASSIFICATION UNRESTRICTED			

Table 1: Qualification Test Matrix

TEST GROUP ID:		1	2	3a	3b	4	5	6	7	
TEST DESCRIPTION	SECTION	Mixed Flowing Gas	Temp Life	Thermal Shock & Humidity	Thermal Shock & Humidity	Vibration & Mech. Shock	Current Rating	Current De-rating	Contact Press-fit Eval	
VISUAL EXAMINATION	5.5	1,23	1,9	1,9	1,13	1,17	1,3	1,3	1	
MATE HEADER & RECEPTACLE		2,8,12	3	2	2,9	3,8				
UNMATE HEADER & RECEPTACLE		6,10			7	6				
ELECTRICAL:										
CONTACT RESISTANCE AT SPECIFIED CURRENT	6.1	3,5,9,13,15,17,19,21	4,6		3,5,11	4,9,11,13,15				
INSULATION RESISTANCE	6.2			4,7						
DIELECTRIC WITHSTANDING VOLTAGE	6.3			5,8						
CURRENT RATING	6.4						2			
CURRENT DE-RATING	6.5	22	8		12	16		2		
MECHANICAL:										
MATING / UNMATING FORCE	7.1					2,10				
CONTACT NORMAL FORCE	7.2		2,7							
PCB INSERTION FORCE	7.3								2,4,6	
PCB RETENTION FORCE	7.4								3,5,8	
PCB HOLE DEFORMATION RADIUS	7.5								9	
PCB HOLE WALL DAMAGE	7.6								10	
PRESS PEG RETENTION TO PCB	7.7									
ENVIRONMENTAL:										
THERMAL SHOCK	8.1			3	4					
CYCLICAL HUMIDITY & TEMP.	8.2			6	10					
TEMPERATURE LIFE	8.3		5						7	
MFG - RECEPTACLE ONLY, 5 DAYS	8.4	7,11								
MFG - MATED, 5 DAYS	8.4	14,16								
VIBRATION	8.5					14				
MECHANICAL SHOCK	8.6					12				
DURABILITY, 98 CYCLES	8.7	20				5				
DURABILITY, 99 CYCLES	8.7	4			6					
DUST COMTAMINATION	8.8				8	7				
DISTURB	8.9	18								
SAMPLES NEEDED (2x2):										
ELEC. TEST BOARDS (RECEPT, 5 oz. Cu traces)		3	3		3	3	2	2		
ELEC. TEST BOARDS (2x2 HDR, 5 oz. Cu traces)		3	3		3	3	1	1		
ELEC. TEST BOARDS (1x2 HDR, 5 oz. Cu traces)							1	1		
ELEC. TEST BOARDS (RECEPT, 2 oz. Cu traces)							2	2		
ELEC. TEST BOARDS (2x2 HDR, 2 oz. Cu traces)							1	1		
ELEC. TEST BOARDS (1x2 HDR, 2 oz. Cu traces)							1	1		
MECHANICAL TEST BOARDS (max holes)									2 rec	
MECHANICAL TEST BOARDS (min holes)			2 rec						2 rec	
2X2 RECEPTACLE ASSEMBLIES		15	15 + 4	10	15	15	12	20		
2X2 HEADER ASSEMBLIES		15	15	10	15	15	6	10		
1X2 HEADER ASSEMBLIES							6	10		
LOOSE PIECE CONTACTS			16 hdr							90 rec
LOOSE PIECE HOUSINGS										

NUMBER GS-12-220	TYPE PRODUCT SPECIFICATION		
TITLE 2mm High Power Connector System		PAGE 15 of 15	REVISION H
		AUTHORIZED BY Tan Chen Hong	DATE 21 Dec 08
		CLASSIFICATION UNRESTRICTED	

REVISION RECORD

<u>REV</u>	<u>PAGE</u>	<u>DESCRIPTION</u>	<u>EC#</u>	<u>DATE</u>
A	all	Formal Release of Specification	V03-0226	03/18/03
B	all	Update for addition of AirMax Power / minor clarifications	V03-1206	25 Nov 03
C	1,4,10	Add para 2.0 reference to lead-free. Increase para 6.3a dielectric withstanding test voltage specification from 1000V to 1500V. Remove reference to test boards in table, test group 3a.	V05-0203	24 Feb 05
D	3	Add description of PCB used for testing	V05-0660	12 July 05
E	2	Section 5.1: Added Coplanar information in current rating table	S05-0282	11 Nov 05
F	2, 3, 4, 5,	Add Power 2x3 & re-phrase associated current rating/de-rating requirement to contact column level instead of connector level	S06-0208	15 Nov 07
G	5	Revised Mating Force	S08-0152	16 May 08
H	2 6	Added section 2.1 and Figure 1~10. Separate current rating table for Right-angle and coplanar application	S08-0406	11 Dec 08