

Description

- Low profile SMD crystal
Resistance welded, hermetically sealed in an inert atmosphere, glass to metal seals on leads
Lead wires are mounted onto a plastic former to create a gull wing mount
- Model HC49/3HSMX
- Model Issue number 16

Frequency Parameters

- Frequency 25.0MHz
- Frequency Tolerance $\pm 30.00\text{ppm}$
- Tolerance Condition @ 25°C $\pm 2^\circ\text{C}$
- Frequency Stability $\pm 30.00\text{ppm}$
- Operating Temperature Range -40.00 to 85.00°C
- Overtone Order Fundamental
- Ageing $\pm 5\text{ppm typ per year @ } 25^\circ\text{C}$

Electrical Parameters

- Load Capacitance (CL) 18.00pF
- Shunt Capacitance (C0) 7pF max
- Drive Level 500 μW max
- ESR 40.00 Ω max

Environmental Parameters

- Shock: 981m/s², 6ms, 3 times in each of 3 mutually perpendicular planes
- Vibration: 10Hz-60Hz, 0.75mm amplitude, 60Hz-500Hz, 98.1m/s², 30mins in 3 mutually perpendicular planes
- Storage Temperature Range: -55 to 125°C

Compliance

- RoHS Status (2011/65/EU) Compliant
- REACH Status Compliant
- MSL Rating (JDEC-STD-033): Not Applicable

Packaging Details

- Pack Style: Reel Tape and reel in accordance with
Pack Size: 1,000 EIA-481-D
- *Alternative packing option available*

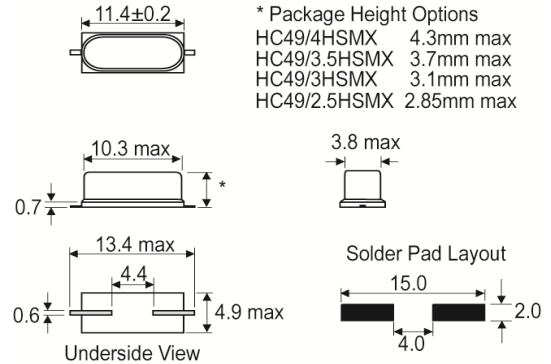
Outline (mm)

Sales Office Contact Details:

 UK: +44 (0)1460 270200
 Germany: 0800 1808 443

 France: 0800 901 383
 USA: +1.760.318.2824

 Email: info@iqdfrequencyproducts.com
 Web: www.iqdfrequencyproducts.com