



Main

Range of product	Modicon M221
Product or component type	Logic controller
[Us] rated supply voltage	100...240 V AC
Discrete input number	14 discrete input conforming to IEC 61131-2 Type 1
Analogue input number	2 at input range: 0...10 V
Discrete output type	Relay normally open
Discrete output number	10 relay
Discrete output voltage	5...125 V DC 5...250 V AC
Discrete output current	2 A

Complementary

Discrete I/O number	24
Number of I/O expansion module	<= 7 for transistor output <= 7 for relay output
Supply voltage limits	85...264 V
Network frequency	50/60 Hz
Inrush current	<= 40 A
Power consumption in VA	<= 58 VA at 100...240 V with max number of I/O expansion module <= 35 VA at 100...240 V without I/O expansion module
Power supply output current	0.52 A at 5 V for expansion bus 0.16 A at 24 V for expansion bus
Discrete input logic	Sink or source (positive/negative)
Discrete input voltage	24 V
Discrete input voltage type	DC
Analogue input resolution	10 bits
LSB value	10 mV
Conversion time	1 ms per channel + 1 controller cycle time for analog input
Permitted overload on inputs	+/- 30 V DC for analog input with 5 min maximum +/- 13 V DC for analog input permanent

Disclaimer: This documentation is not intended as a substitute for and is not to be used for determining suitability or reliability of these products for specific user applications

Voltage state 1 guaranteed	≥ 15 V for input
Voltage state 0 guaranteed	≤ 5 V for input
Discrete input current	7 mA for discrete input 5 mA for fast input
Input impedance	4.9 kOhm for fast input 3.4 kOhm for discrete input 100 kOhm for analog input
Response time	10 ms turn-on operation for output 35 μ s turn-off operation for input; I2...I5 terminal 10 ms turn-off operation for output 5 μ s turn-on operation for fast input; I0, I1, I6, I7 terminal 35 μ s turn-on operation for input; other terminals terminal 5 μ s turn-off operation for fast input; I0, I1, I6, I7 terminal 100 μ s turn-off operation for input; other terminals terminal
Configurable filtering time	0 ms for input 12 ms for input 3 ms for input
Output voltage limits	125 V DC 277 V AC
Current per output common	4 A at COM 2 terminal 7 A at COM 0 terminal 7 A at COM 1 terminal
Absolute accuracy error	± 1 % of full scale for analog input
Electrical durability	Inductive AC-15, ($\cos \phi = 0.35$) 240 V / 120 VA : 100000 cycles Resistive DC-12, 24 V / 48 W : 100000 cycles Resistive AC-12, 120 V / 240 VA : 100000 cycles Inductive AC-15, ($\cos \phi = 0.35$) 240 V / 36 VA : 300000 cycles Resistive AC-12, 120 V / 80 VA : 300000 cycles Inductive (L/R = 7 ms) DC-13, 24 V / 24 W : 100000 cycles Resistive DC-12, 24 V / 16 W : 300000 cycles Inductive (L/R = 7 ms) DC-13, 24 V / 7.2 W : 300000 cycles Inductive AC-14, ($\cos \phi = 0.7$) 240 V / 240 VA : 100000 cycles Inductive AC-15, ($\cos \phi = 0.35$) 120 V / 60 VA : 100000 cycles Inductive AC-14, ($\cos \phi = 0.7$) 240 V / 72 VA : 300000 cycles Inductive AC-15, ($\cos \phi = 0.35$) 120 V / 18 VA : 300000 cycles Resistive AC-12, 240 V / 480 VA : 100000 cycles Inductive AC-14, ($\cos \phi = 0.7$) 120 V / 120 VA : 100000 cycles Resistive AC-12, 240 V / 160 VA : 300000 cycles Inductive AC-14, ($\cos \phi = 0.7$) 120 V / 36 VA : 300000 cycles
Switching frequency	20 switching operations/minute with maximum load
Mechanical durability	≥ 20000000 cycles for relay output
Minimum load	1 mA at 5 V DC for relay output
Protection type	Without protection at 5 A
Reset time	1 s
Memory capacity	256 kB for user application and data RAM with 10000 instructions 256 kB for internal variables RAM
Data backed up	256 kB built-in flash memory for backup of application and data
Data storage equipment	2 GB SD card optional
Battery type	BR2032 lithium non-rechargeable, battery life: 4 yr
Backup time	1 year at 25 °C by interruption of power supply
Execution time for 1 KInstruction	0.3 ms for event and periodic task
Execution time per instruction	0.2 μ s Boolean
Exct time for event task	60 μ s response time
Maximum size of object areas	512 %M memory bits 512 %KW constant words 255 %C counters 8000 %MW memory words 255 %TM timers
Realtime clock	With
Clock drift	≤ 30 s/month at 25 °C
Regulation loop	Adjustable PID regulator up to 14 simultaneous loops
Counting input number	4 fast input (HSC mode) (counting frequency: 100 kHz), counting capacity: 32 bits
Control signal type	A/B

	Pulse/Direction Single phase
Integrated connection type	USB port with connector mini B USB 2.0 Ethernet with connector RJ45 Non isolated serial link "serial 1" with connector RJ45 and interface RS232/RS485
Supply	Serial serial link supply at 5 V 200 mA
Transmission rate	1.2...115.2 kbit/s (115.2 kbit/s by default) for bus length of 15 m - communication protocol: RS485 1.2...115.2 kbit/s (115.2 kbit/s by default) for bus length of 3 m - communication protocol: RS232 480 Mbit/s - communication protocol: USB
Communication port protocol	USB port : USB protocol - SoMachine-Network Non isolated serial link : Modbus protocol master/slave - RTU/ASCII or SoMachine-Network : Ethernet protocol
Port Ethernet	10BASE-T/100BASE-TX 1 port with 100 m copper cable
Communication service	DHCP client Modbus TCP client Modbus TCP server Ethernet/IP adapter Modbus TCP slave device
Local signalling	1 LED green for SD card access (SD) 1 LED red for BAT 1 LED per channel green for I/O state 1 LED green for SL Ethernet network activity green for ACT Ethernet network link yellow for Link (Link Status) 1 LED red for module error (ERR) 1 LED green for PWR 1 LED green for RUN
Electrical connection	Mini B USB 2.0 connector for a programming terminal Terminal block, 3 terminal(s) for connecting the 24 V DC power supply Connector, 4 terminal(s) for analogue inputs Removable screw terminal block for inputs Removable screw terminal block for outputs
Cable distance between devices	Shielded cable: 10 m for fast input Unshielded cable: 30 m for output Unshielded cable: 30 m for digital input Unshielded cable: 1 m for analog input
Insulation	2300 V AC between output and internal logic Non-insulated between analogue inputs 500 V AC between input and internal logic Non-insulated between analogue input and internal logic 1500 V AC between supply and ground 500 V AC between sensor power supply and ground 500 V AC between input and ground 1500 V AC between output and ground 2300 V AC between supply and internal logic 500 V AC between sensor power supply and internal logic 500 V AC between Ethernet terminal and internal logic 2300 V AC between supply and sensor power supply
Marking	CE
Sensor power supply	24 V DC at 250 mA supplied by the controller
Mounting support	Top hat type TH35-15 rail conforming to IEC 60715 Top hat type TH35-7.5 rail conforming to IEC 60715 Plate or panel with fixing kit
Height	90 mm
Depth	70 mm
Width	110 mm
Product weight	0.395 kg

Environment

Standards	EN/IEC 60664-1 EN/IEC 61010-2-201 EN/IEC 61131-2
Product certifications	LR EAC DNV-GL IACS E10

CSA
RCM
ABS
cULus

Environmental characteristic	Ordinary and hazardous location
Resistance to electrostatic discharge	4 kV on contact conforming to EN/IEC 61000-4-2 8 kV in air conforming to EN/IEC 61000-4-2
Resistance to electromagnetic fields	10 V/m (80 MHz...1 GHz) conforming to EN/IEC 61000-4-3 3 V/m (1.4 GHz...2 GHz) conforming to EN/IEC 61000-4-3 1 V/m (2...2.7 GHz) conforming to EN/IEC 61000-4-3
Resistance to magnetic fields	30 A/m 50/60 Hz conforming to EN/IEC 61000-4-8
Resistance to fast transients	2 kV for power lines conforming to EN/IEC 61000-4-4 2 kV for relay output conforming to EN/IEC 61000-4-4 1 kV for Ethernet line conforming to EN/IEC 61000-4-4 1 kV for serial link conforming to EN/IEC 61000-4-4 1 kV for I/O conforming to EN/IEC 61000-4-4
Surge withstand	2 kV for power lines (AC) in common mode conforming to EN/IEC 61000-4-5 2 kV for relay output in common mode conforming to EN/IEC 61000-4-5 1 kV for I/O in common mode conforming to EN/IEC 61000-4-5 1 kV for shielded cable in common mode conforming to EN/IEC 61000-4-5 0.5 kV for power lines (DC) in differential mode conforming to EN/IEC 61000-4-5 1 kV for power lines (AC) in differential mode conforming to EN/IEC 61000-4-5 1 kV for relay output in differential mode conforming to EN/IEC 61000-4-5 0.5 kV for power lines (DC) in common mode conforming to EN/IEC 61000-4-5
Resistance to conducted disturbances	10 Vrms (0.15...80 MHz) conforming to EN/IEC 61000-4-6 3 Vrms (0.1...80 MHz) conforming to Marine specification (LR, ABS, DNV, GL) 10 Vrms (spot frequency (2, 3, 4, 6.2, 8.2, 12.6, 16.5, 18.8, 22, 25 MHz)) conforming to Marine specification (LR, ABS, DNV, GL)
Electromagnetic emission	Conducted emissions conforming to EN/IEC 55011 power lines (AC), 0.15...0.5 MHz : 79 dB μ V/m QP/66 dB μ V/m AV Conducted emissions conforming to EN/IEC 55011 power lines (AC), 0.5...300 MHz : 73 dB μ V/m QP/60 dB μ V/m AV Conducted emissions conforming to EN/IEC 55011 power lines, 10...150 kHz : 120...69 dB μ V/m QP Conducted emissions conforming to EN/IEC 55011 power lines, 1.5...30 MHz : 63 dB μ V/m QP Radiated emissions conforming to EN/IEC 55011 class A 10 m, 30...230 MHz : 40 dB μ V/m QP Conducted emissions conforming to EN/IEC 55011 power lines, 150...1500 kHz : 79...63 dB μ V/m QP Radiated emissions conforming to EN/IEC 55011 class A 10 m, 200...1000 MHz : 47 dB μ V/m QP
Immunity to microbreaks	10 ms
Ambient air temperature for operation	-10...55 °C for horizontal installation -10...35 °C for vertical installation
Ambient air temperature for storage	-25...70 °C
Relative humidity	10...95 % without condensation in operation 10...95 % without condensation in storage
IP degree of protection	IP20 with protective cover in place
Pollution degree	<= 2
Operating altitude	0...2000 m
Storage altitude	0...3000 m
Vibration resistance	3.5 mm (vibration frequency: 5...8.4 Hz) on symmetrical rail 1 gn (vibration frequency: 8.4...150 Hz) on symmetrical rail 3.5 mm (vibration frequency: 5...8.4 Hz) on panel mounting 1 gn (vibration frequency: 8.4...150 Hz) on panel mounting
Shock resistance	98 m/s ² (test wave duration:11 ms)

Offer Sustainability

Sustainable offer status	Green Premium product
RoHS (date code: YYWW)	Compliant - since 1415 - Schneider Electric declaration of conformity Schneider Electric declaration of conformity
REACH	Reference not containing SVHC above the threshold Reference not containing SVHC above the threshold
Product environmental profile	Available Product environmental
Product end of life instructions	Available

Dimensiones

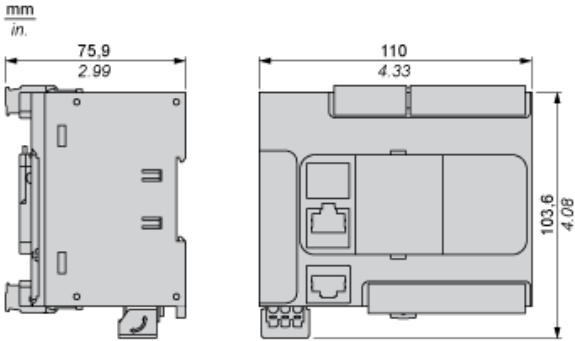

Montaje en un segmento

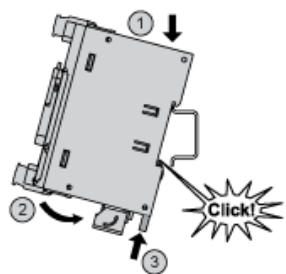

Montaje directo sobre la superficie de un panel

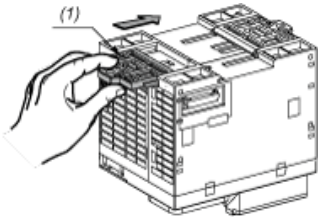

- (1) Instalar una regleta de montaje

Disposición de los orificios de montaje

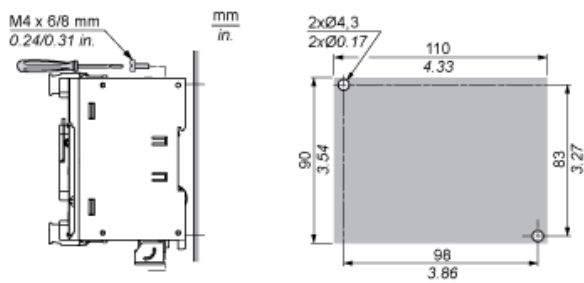

Montaje

Posición de montaje correcta

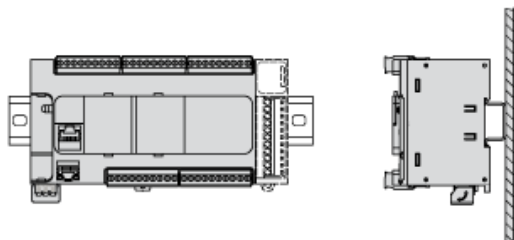

Posición de montaje aceptable

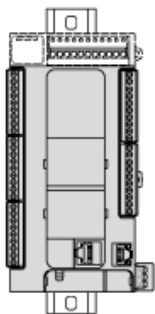

Posición de montaje incorrecta

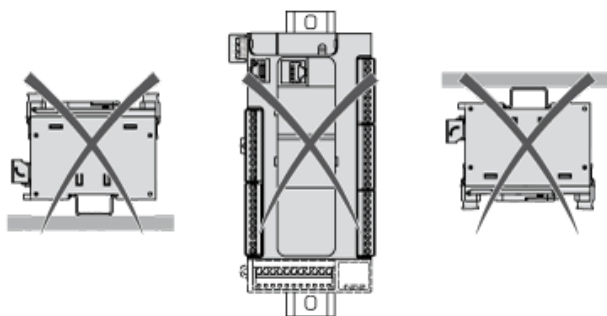

Distancia

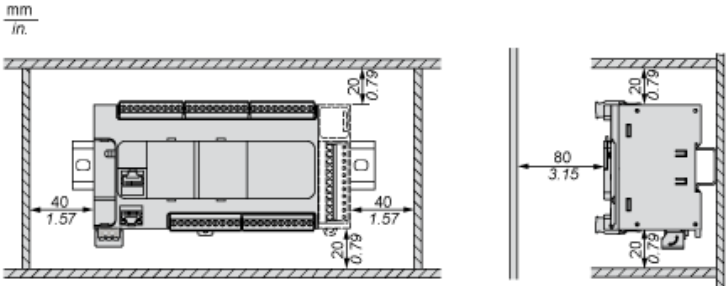

Entradas digitales

Diagrama de cableado (lógica positiva)

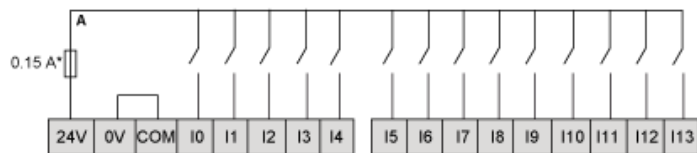

(*) Fusible tipo T

Diagrama de cableado (lógica negativa)

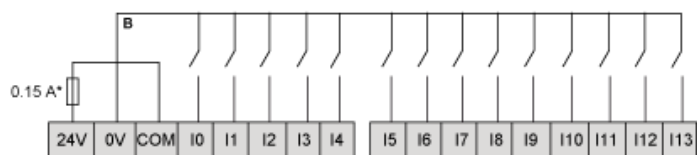

(*) Fusible tipo T

Conexión de las entradas rápidas

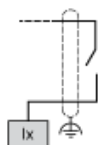

I0, I1, I6, I7

Salidas de relé

Lógica negativa (común negativo)

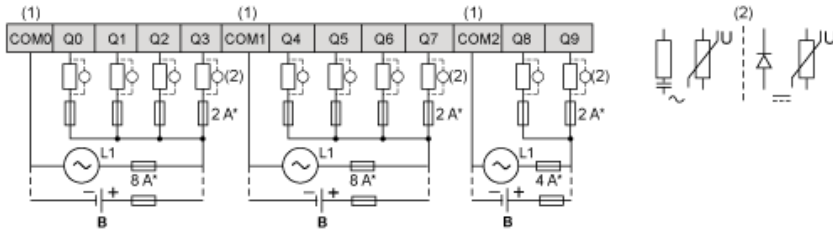

(*) Fusible tipo T

(1) Los terminales COM0, COM1 y COM2 no están conectados internamente.

(2) Para mejorar la vida útil de los contactos y como protección contra posibles daños por carga inductiva, debe conectar en paralelo un diodo de ejecución

B Cableado de común negativo (lógica negativa)

Lógica positiva (común positivo)

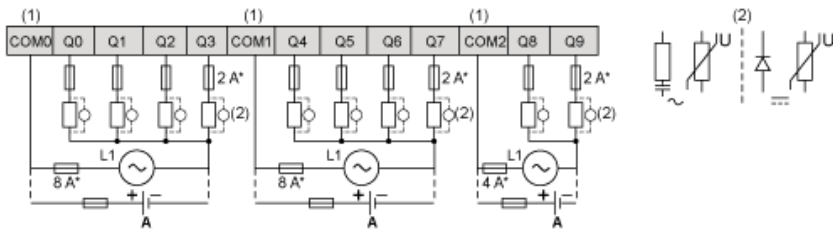

(*) Fusible tipo T

(1) Los terminales COM0, COM1 y COM2 no están conectados internamente.

(2) Para mejorar la vida útil de los contactos y como protección contra posibles daños por carga inductiva, debe conectar en paralelo un diodo de ejecución

A Cableado de común positivo (lógica positiva)

Entradas analógicas

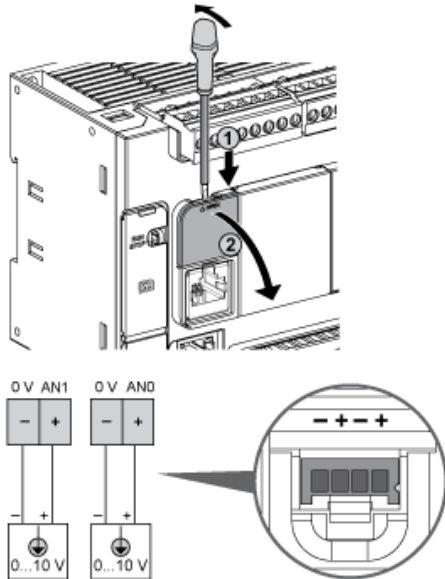

Los polos (-) se conectan internamente.

Pin	Color del cable
0 V	Negro
AN1	Rojo
0 V	Negro
AN0	Rojo

Conexión Ethernet

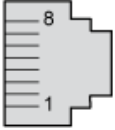

N.º de pin	Señal
1	TD +
2	TD-
3	RD +
4	-
5	-
6	RD-
7	-
8	-

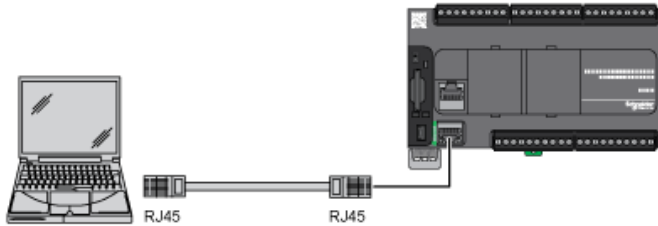

Conexión USB mini B

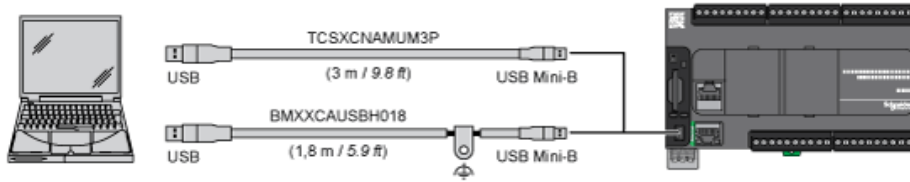

Conexión SL1

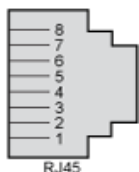

SL1

N.º	RS232	RS485
1	RxD	N.C.
2	TxD	N.C.
3	RTS	N.C.
4	N.C.	D1
5	N.C.	D0
6	CTS	N.C.
7	N. C.*	5 V CC
8	Común	Común

N.C.: no conectado

*: 5 V CC entregados por el controlador. No conectar.

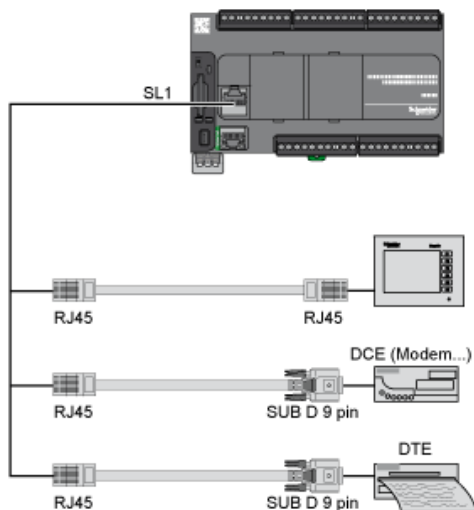

Curvas de desclasificación

Entradas digitales incrustadas (sin cartucho)

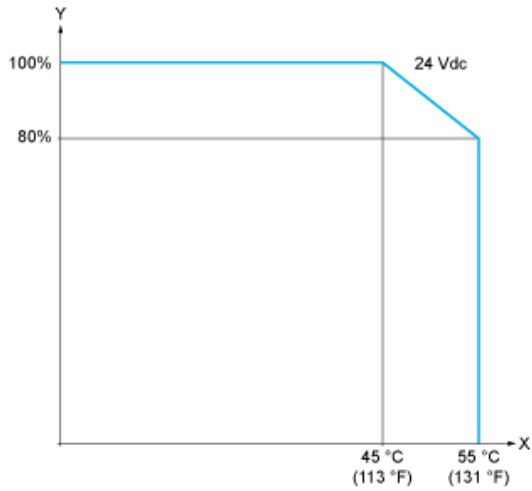

X: Temperatura ambiente
Y: Relación de entradas simultáneas en ON

Entradas digitales incrustadas (con cartucho)

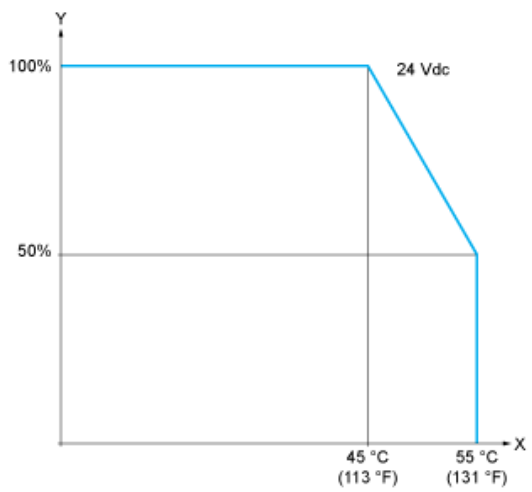

X: Temperatura ambiente
Y: Relación de entradas simultáneas en ON