

LM321

Single Channel Operational Amplifier

LM321 is a general purpose, single channel op amp with internal compensation and a true differential input stage. This op amp features a wide supply voltage ranging from 3 V to 32 V for single supplies and ± 1.5 to ± 16 V for split supplies, suiting a variety of applications. LM321 is unity gain stable even with large capacitive loads up to 1.5 nF. LM321 is available in a space-saving TSOP-5/SOT23-5 package.

Features

- Wide Supply Voltage Range: 3 V to 32 V
- Short Circuit Protected Outputs
- True Differential Input Stage
- Low Input Bias Currents
- Internally Compensated
- Single and Split Supply Operation
- Unity Gain Stable with 1.5 nF Capacitive Load
- This Device is Pb-Free, Halogen Free/BFR Free and is RoHS Compliant

Typical Applications

- Gain Stage
- Active Filter
- Signal Processing



ON Semiconductor®

www.onsemi.com

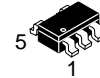

TSOP-5
CASE 483

PIN CONNECTION

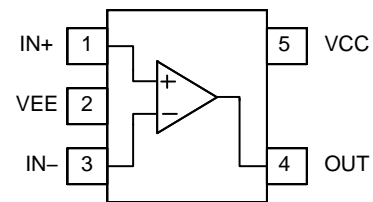

MARKING DIAGRAM

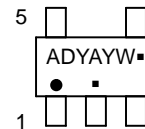

ADY = Specific Device Code
A = Assembly Location
Y = Year
W = Work Week
▪ = Pb-Free Package

(Note: Microdot may be in either location)

ORDERING INFORMATION

Device	Package	Shipping†
LM321SN3T1G	TSOP-5 (Pb-Free)	3000 / Tape & Reel

†For information on tape and reel specifications, including part orientation and tape sizes, please refer to our Tape and Reel Packaging Specification Brochure, BRD8011/D.

LM321

Table 1. ABSOLUTE MAXIMUM RATINGS (Over operating free-air temperature, unless otherwise stated)

Parameter	Rating	Unit
Supply Voltage	36	V
INPUT AND OUTPUT PINS		
Input Voltage	$V_{EE} - 0.3$ to 32	V
Input Current	± 10	mA
Output Short Circuit Duration (Note 1)	Continuous	
TEMPERATURE		
Operating Temperature	-40 to +125	°C
Storage Temperature	-65 to +150	°C
Junction Temperature	-65 to +150	°C
ESD RATINGS (Note 2)		
Human Body Model (HBM)	200	V
Charged Device Model (CDM)	800	V
Machine Model (MM)	100	V
OTHER RATINGS		
Latch-Up Current (Note 3)	100	mA
MSL	Level 1	

Stresses exceeding those listed in the Maximum Ratings table may damage the device. If any of these limits are exceeded, device functionality should not be assumed, damage may occur and reliability may be affected.

- Short circuits can cause excessive heating and eventual destruction.
- This device series incorporates ESD protection and is tested by the following methods:
 ESD Human Body Model tested per JEDEC standard: JESD22-A114
 ESD Machine Model tested per JEDEC standard: JESD22-A115
- Latch-up Current tested per JEDEC standard: JESD78

Table 2. THERMAL INFORMATION (Note 4)

Parameter	Symbol	Package	Value	Unit
Junction to Ambient	θ_{JA}	TSOP-5/SOT23-5	235	°C/W

- As mounted on an 80 × 80 × 1.5 mm FR4 PCB with 650 mm² and 2 oz (0.034 mm) thick copper heat spreader. Following JEDEC JESD/EIA 51.1, 51.2, 51.3 test guidelines.

Table 3. RECOMMENDED OPERATING CONDITIONS

Parameter	Symbol	Range	Unit
Supply Voltage ($V_{CC} - V_{EE}$)	V_S	3 to 32	V
Specified Operating Range	T_A	-40 to 85	°C
Common Mode Input Voltage Range	V_{CM}	V_{EE} to $V_{CC} - 1.7$	V

Functional operation above the stresses listed in the Recommended Operating Ranges is not implied. Extended exposure to stresses beyond the Recommended Operating Ranges limits may affect device reliability.

LM321

Table 4. ELECTRICAL CHARACTERISTICS – $V_S = 5\text{ V}$

(At $T_A = +25^\circ\text{C}$, $R_L = 10\text{ k}\Omega$ connected to mid-supply, $V_{CM} = V_{OUT} = \text{mid-supply}$, unless otherwise noted.)

Boldface limits apply over the specified temperature range, $T_A = -40^\circ\text{C}$ to 85°C , guaranteed by characterization and/or design.)

Parameter	Symbol	Conditions	Min	Typ	Max	Unit
INPUT CHARACTERISTICS						
Offset Voltage	V_{OS}	$V_S = 5\text{ V}$, $V_{CM} = V_{EE}$ to $V_{CC} - 1.7\text{ V}$ $T_A = 25^\circ\text{C}$ $T_A = -40^\circ\text{C}$ to 85°C	– –	0.3 –	7 9	mV
Offset Voltage Drift vs Temp	$\Delta V_{OS}/\Delta T$	$T_A = -40^\circ\text{C}$ to 85°C	–	7	–	$\mu\text{V}/^\circ\text{C}$
Input Bias Current	I_{IB}	$T_A = 25^\circ\text{C}$ $T_A = -40^\circ\text{C}$ to 85°C	– –	–10 –	– –500	nA
Input Offset Current	I_{OS}	$T_A = 25^\circ\text{C}$ $T_A = -40^\circ\text{C}$ to 85°C	– –	1 –	– 150	nA
Common Mode Rejection Ratio	CMRR	$V_{CM} = V_{EE}$ to $V_{CC} - 1.7\text{ V}$	65	85	–	dB
Input Resistance	R_{IN}	Differential Common Mode	– –	85 300	– –	$\text{G}\Omega$
Input Capacitance	C_{IN}	Differential Common Mode	– –	0.6 1.6	– –	pF
OUTPUT CHARACTERISTICS						
Open Loop Voltage Gain	A_{VOL}		–	100	–	dB
Open Loop Output Impedance	Z_{OUT_OL}	$f = \text{UGBW}$, $I_O = 0\text{ mA}$	–	1,200	–	Ω
Output Voltage High	V_{OH}	$R_L = 2\text{ k}\Omega$ to V_{EE} $R_L = 10\text{ k}\Omega$ to V_{EE}	$V_{CC}-1.8$ $V_{CC}-1.8$	$V_{CC}-1.4$ $V_{CC}-1.4$	– –	V
Output Voltage Low	V_{OL}	$R_L = 10\text{ k}\Omega$ to V_{CC}	–	$V_{EE}+0.8$	$V_{EE}+1.0$	V
Output Current Capability	I_O	Sinking Current $V_S = 5\text{ V}$ $V_S = 15\text{ V}$	10 10	20 20	– –	mA
Output Current Capability	I_O	Sourcing Current $V_S = 5\text{ V}$ $V_S = 15\text{ V}$	20 20	40 40	– –	mA
Capacitive Load Drive	C_L	Phase Margin = 15°	–	1,500	–	pF
NOISE PERFORMANCE						
Voltage Noise Density	e_N	$f_{IN} = 1\text{ kHz}$	–	40	–	nV/ $\sqrt{\text{Hz}}$
DYNAMIC PERFORMANCE						
Gain Bandwidth Product	GBWP	$C_L = 25\text{ pF}$, R_L to V_{CC}	–	750	–	kHz
Gain Margin	A_M	$C_L = 25\text{ pF}$, R_L to V_{CC}	–	14	–	dB
Phase Margin	α_M	$C_L = 25\text{ pF}$, R_L to V_{CC}	–	60	–	$^\circ$
Slew Rate	SR	$C_L = 25\text{ pF}$, $R_L = \infty$	–	0.3	–	V/ μs
POWER SUPPLY						
Power Supply Rejection Ratio	PSRR	$V_S = 5\text{ V}$ to 32 V	62	100	–	dB
Quiescent Current	I_Q	No Load	–	0.25	0.5	mA

Product parametric performance is indicated in the Electrical Characteristics for the listed test conditions, unless otherwise noted. Product performance may not be indicated by the Electrical Characteristics if operated under different conditions.

LM321

Table 5. ELECTRICAL CHARACTERISTICS – $V_S = 32\text{ V}$

(At $T_A = +25^\circ\text{C}$, $R_L = 10\text{ k}\Omega$ connected to mid-supply, $V_{CM} = V_{OUT} = \text{mid-supply}$, unless otherwise noted.)

Boldface limits apply over the specified temperature range, $T_A = -40^\circ\text{C}$ to 85°C , guaranteed by characterization and/or design.)

Parameter	Symbol	Conditions	Min	Typ	Max	Unit
-----------	--------	------------	-----	-----	-----	------

INPUT CHARACTERISTICS

Offset Voltage	V_{OS}	$V_S = 32\text{ V}$, $V_{CM} = V_{EE}$ to $V_{CC} - 1.7\text{ V}$ $T_A = 25^\circ\text{C}$ $T_A = -40^\circ\text{C}$ to 85°C	– –	0.3 –	7 9	mV
Offset Voltage Drift vs Temp	$\Delta V_{OS}/\Delta T$	$T_A = -40^\circ\text{C}$ to 85°C	–	7	–	$\mu\text{V}/^\circ\text{C}$
Common Mode Rejection Ratio	CMRR	$V_{CM} = V_{EE}$ to $V_{CC} - 1.7\text{ V}$	–	100	–	dB

OUTPUT CHARACTERISTICS

Open Loop Voltage Gain	A_{VOL}	$T_A = 25^\circ\text{C}$ $T_A = -40^\circ\text{C}$ to 85°C	– 84	100 –	– –	dB
Open Loop Output Impedance	Z_{OUT_OL}	$f = \text{UGBW}$, $I_O = 0\text{ mA}$	–	2,000	–	Ω
Output Voltage High	V_{OH}	$R_L = 2\text{ k}\Omega$ to V_{EE} $R_L = 10\text{ k}\Omega$ to V_{EE}	$V_{CC}-2.5$ $V_{CC}-2.5$	$V_{CC}-2.0$ $V_{CC}-1.5$	– –	V
Output Voltage Low	V_{OL}	$R_L = 10\text{ k}\Omega$ to V_{CC}	–	$V_{EE}+1.0$	$V_{EE}+1.5$	V
Capacitive Load Drive	C_L	Phase Margin = 15°	–	1,500	–	pF

NOISE PERFORMANCE

Voltage Noise Density	e_N	$f_{IN} = 1\text{ kHz}$	–	40	–	$\text{nV}/\sqrt{\text{Hz}}$
Total Harmonic Distortion + Noise	THD+N	$V_S = 30\text{ V}$, $f_{IN} = 1\text{ kHz}$, R_L to V_{CC}	–	0.02	–	%

DYNAMIC PERFORMANCE

Gain Bandwidth Product	GBWP	$C_L = 25\text{ pF}$, R_L to V_{CC}	–	900	–	kHz
Gain Margin	A_M	$C_L = 25\text{ pF}$, R_L to V_{CC}	–	18	–	dB
Phase Margin	α_M	$C_L = 25\text{ pF}$, R_L to V_{CC}	–	66	–	$^\circ$
Slew Rate	SR	$C_L = 25\text{ pF}$, $R_L = \infty$	–	0.4	–	$\text{V}/\mu\text{s}$

POWER SUPPLY

Power Supply Rejection Ratio	PSRR	$V_S = 5\text{ V}$ to 32 V	62	100	–	dB
Quiescent Current	I_Q	No Load, $V_S = 32\text{ V}$	–	0.3	1.2	mA

Product parametric performance is indicated in the Electrical Characteristics for the listed test conditions, unless otherwise noted. Product performance may not be indicated by the Electrical Characteristics if operated under different conditions.

TYPICAL CHARACTERISTICS

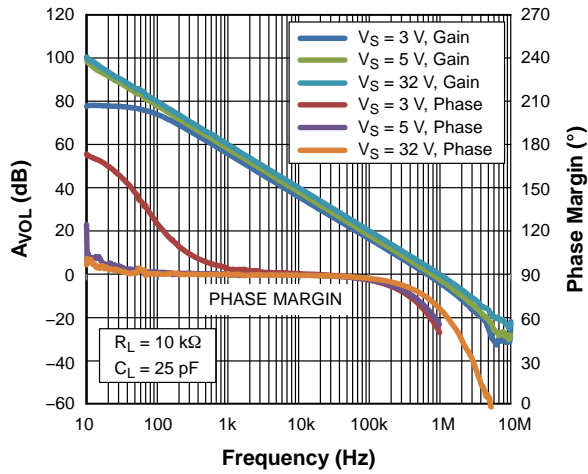

Figure 1. Open Loop Gain and Phase Margin vs. Frequency

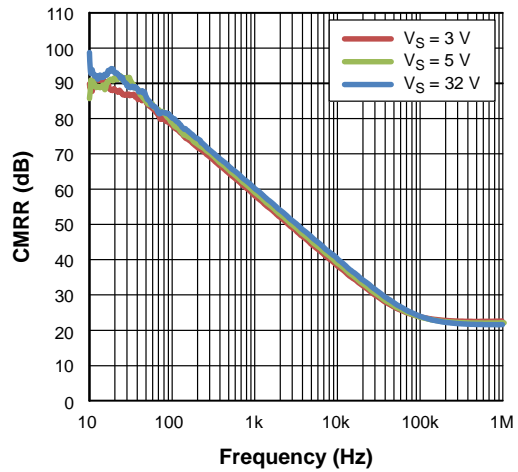

Figure 2. CMRR vs. Frequency

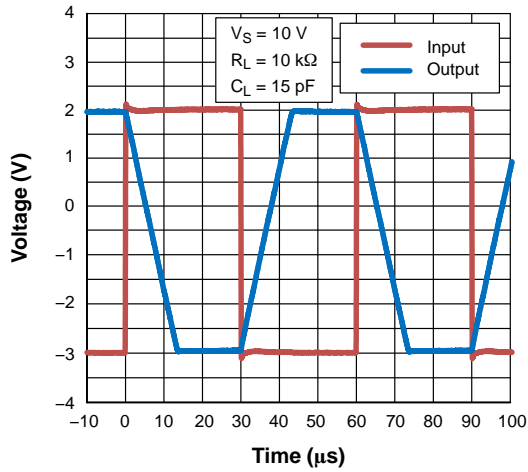

Figure 3. Inverting Large Signal Step Response

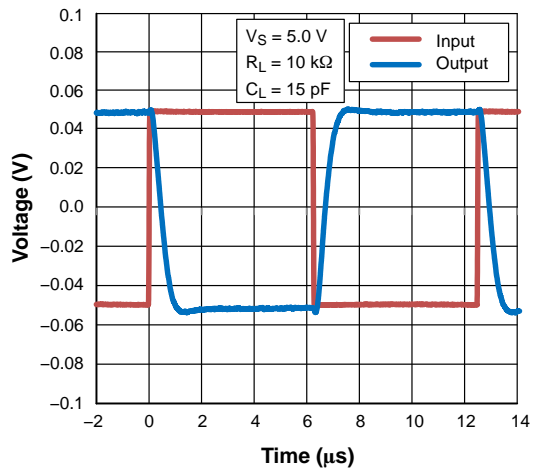

Figure 4. Inverting Small Signal Step Response

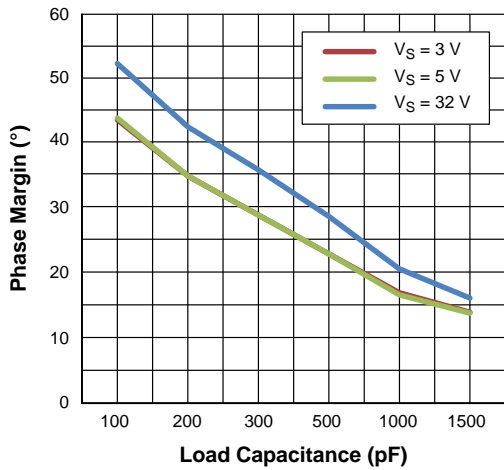

Figure 5. Phase Margin vs. Load Capacitance

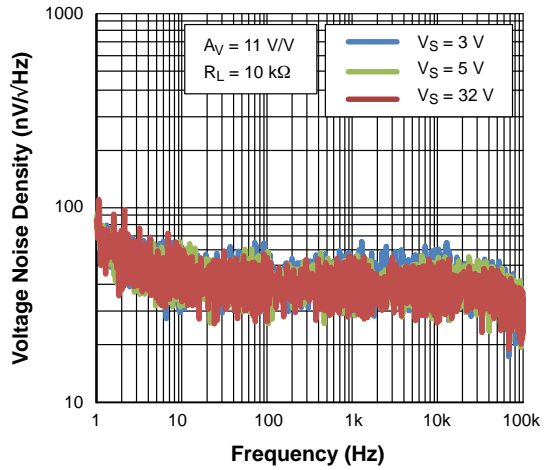

Figure 6. Voltage Noise Density vs. Frequency

LM321

TYPICAL CHARACTERISTICS

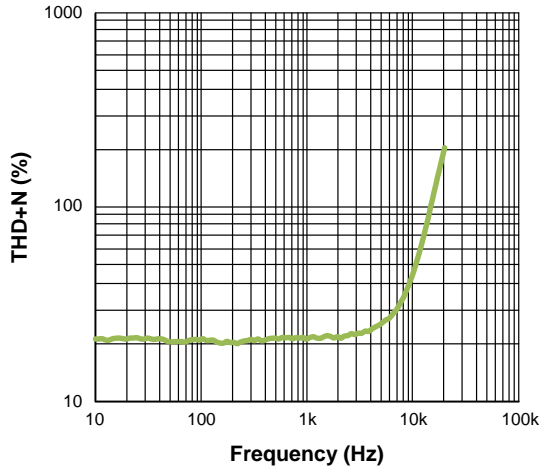

Figure 7. THD+N vs. Frequency

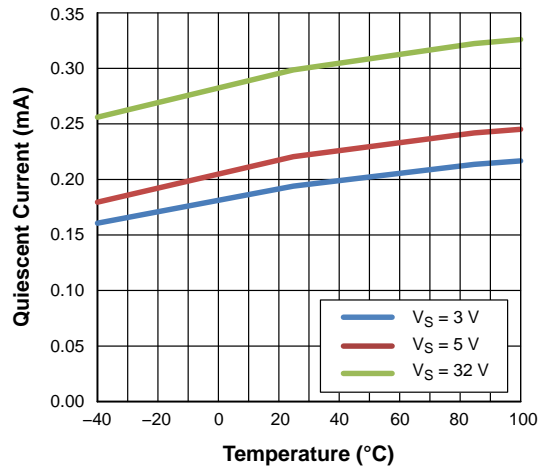

Figure 8. Quiescent Current vs. Temperature

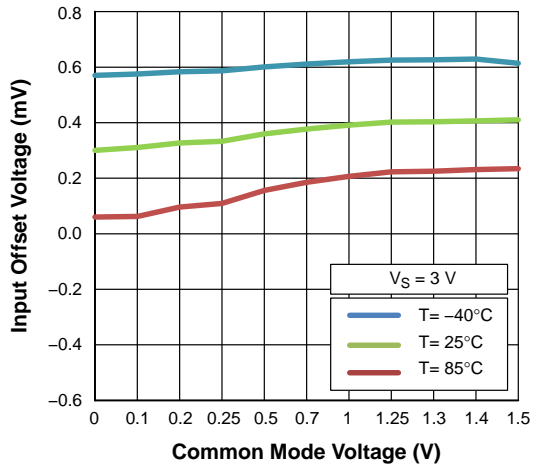

Figure 9. Input Offset Voltage vs. Common Mode Voltage at 3 V Supply

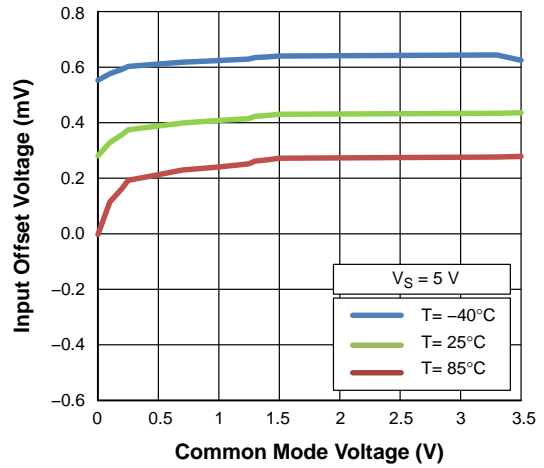

Figure 10. Input Offset Voltage vs. Common Mode Voltage at 5 V Supply

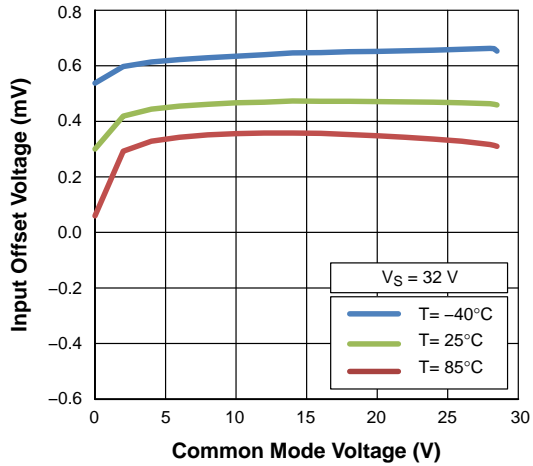

Figure 11. Input Offset Voltage vs. Common Mode Voltage at 32 V Supply

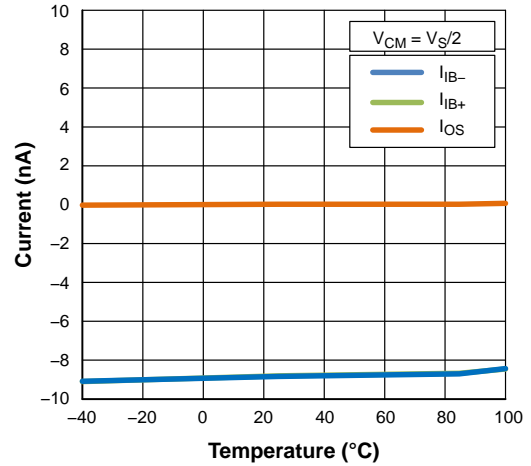

Figure 12. Input Bias and Offset Current vs. Temperature

LM321

TYPICAL CHARACTERISTICS

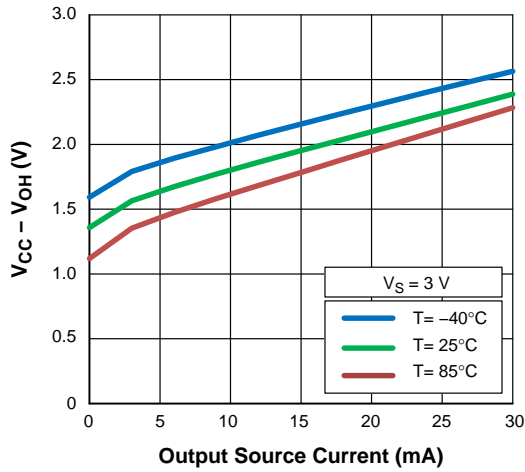

Figure 13. High Level Output Voltage Swing vs. Output Current at 3 V Supply

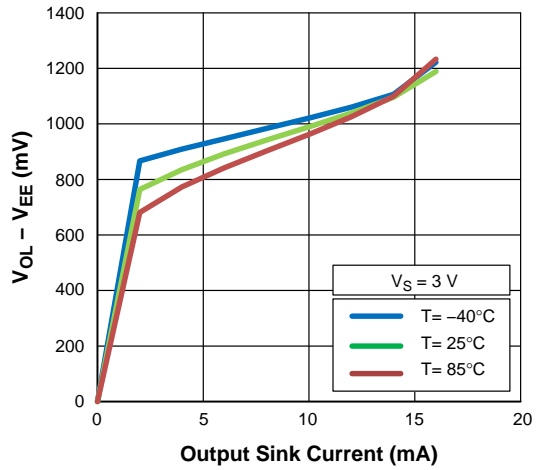

Figure 14. Low Level Output Voltage Swing vs. Output Current at 3 V Supply

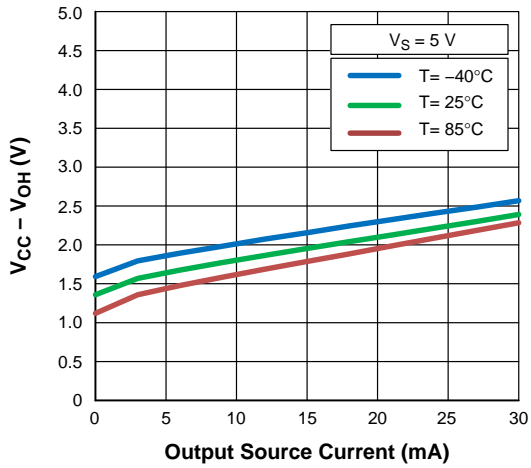

Figure 15. High Level Output Voltage Swing vs. Output Current at 5 V Supply

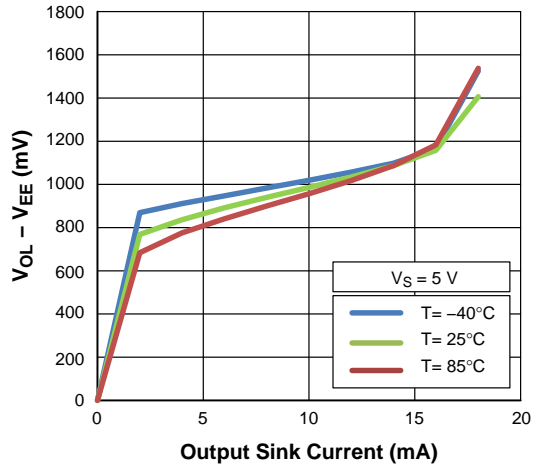

Figure 16. Low Level Output Voltage Swing vs. Output Current at 5 V Supply

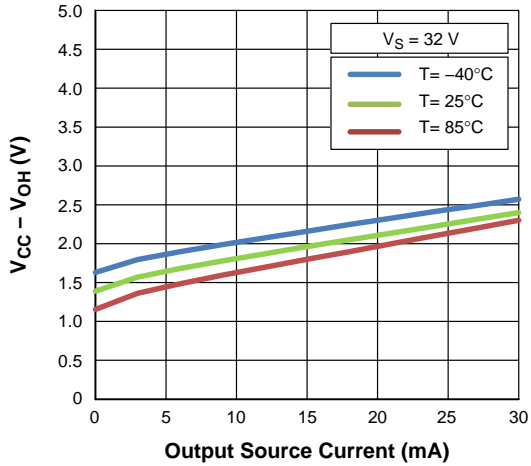

Figure 17. High Level Output Voltage Swing vs. Output Current at 32 V Supply

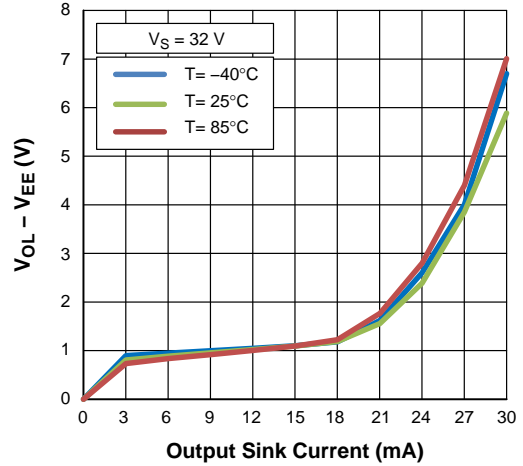

Figure 18. Low Level Output Voltage Swing vs. Output Current at 5 V Supply32

LM321

APPLICATION INFORMATION

CIRCUIT DESCRIPTION

The LM321 is made using two internally compensated, two-stage operational amplifiers. The first stage of each consists of differential input devices Q20 and Q18 with input buffer transistors Q21 and Q17 and the differential to single ended converter Q3 and Q4. The first stage performs not only the first stage gain function but also performs the level shifting and transconductance reduction functions. By reducing the transconductance, a smaller compensation capacitor (only 5.0 pF) can be employed, thus saving chip area. The transconductance reduction is accomplished by

splitting the collectors of Q20 and Q18. Another feature of this input stage is that the input common mode range can include the negative supply or ground, in single supply operation, without saturating either the input devices or the differential to single-ended converter. The second stage consists of a standard current source load amplifier stage.

Each amplifier is biased from an internal-voltage regulator which has a low temperature coefficient thus giving each amplifier good temperature characteristics as well as excellent power supply rejection.

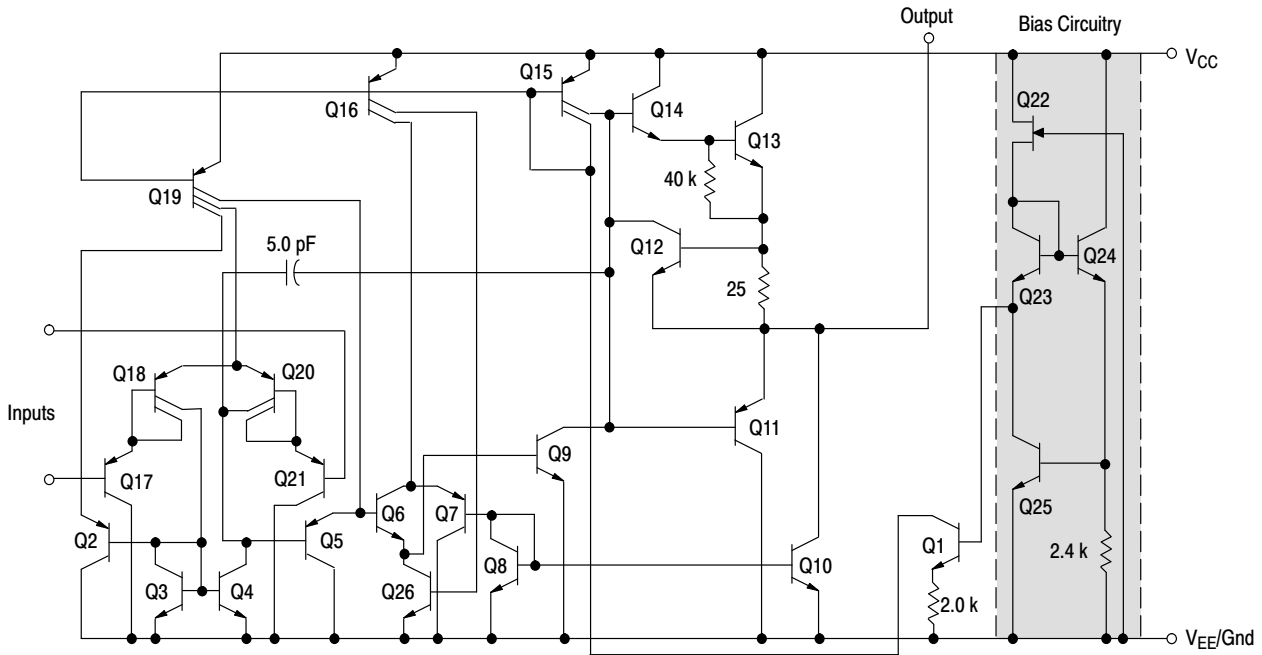

Figure 19. LM321 Representative Schematic Diagram

LM321

LM321 has a class B output stage, which is comprised of push-pull transistors. This type of output is inherently subject to crossover distortion near mid-rail where neither push or pull transistors are conducting. Several techniques can be used to minimize crossover distortion. Connecting the output load to either the positive or negative supply rail instead of mid-rail can reduce the crossover distortion. Additionally, increasing the load resistance relatively decreases the amount of crossover distortion.

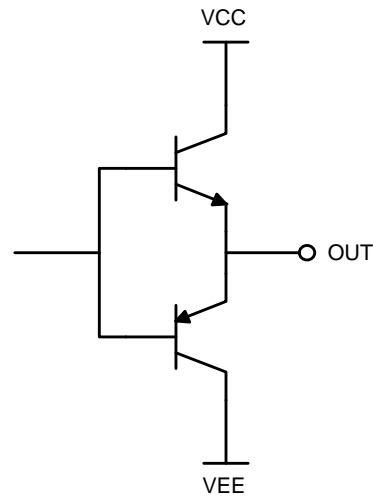

Figure 20. Simplified Class B Output

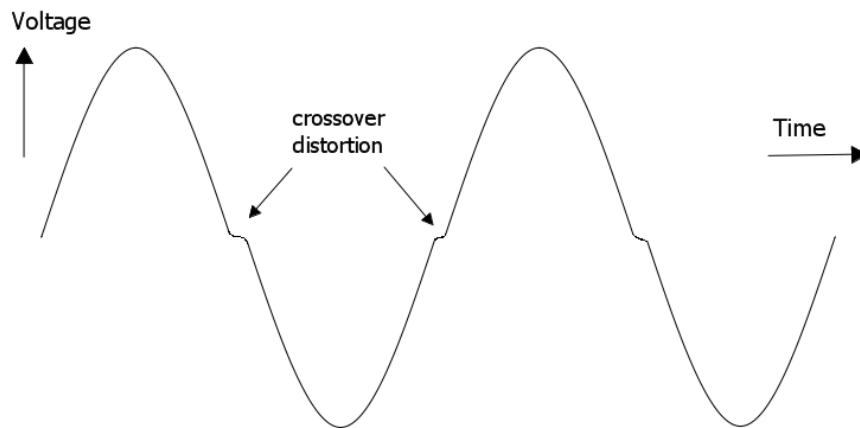
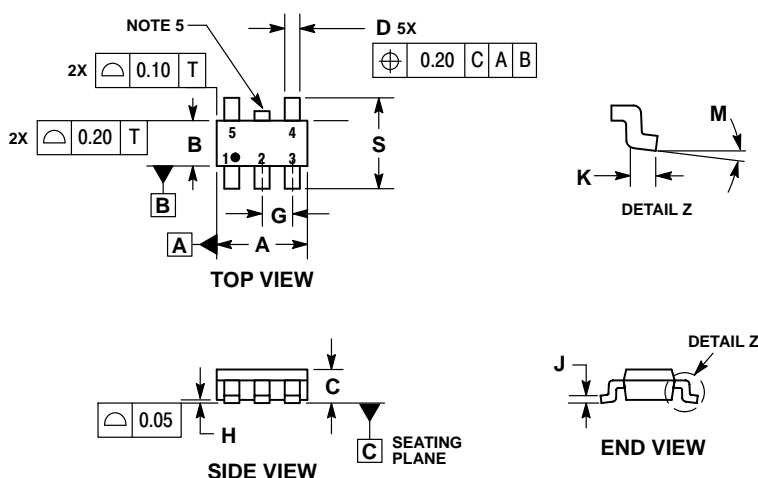

Figure 21. Sine wave with crossover distortion

LM321

PACKAGE DIMENSIONS

TSOP-5
CASE 483
ISSUE L



NOTES:

1. DIMENSIONING AND TOLERANCING PER ASME Y14.5M, 1994.
2. CONTROLLING DIMENSION: MILLIMETERS.
3. MAXIMUM LEAD THICKNESS INCLUDES LEAD FINISH THICKNESS. MINIMUM LEAD THICKNESS IS THE MINIMUM THICKNESS OF BASE MATERIAL.
4. DIMENSIONS A AND B DO NOT INCLUDE MOLD FLASH, PROTRUSIONS, OR GATE BURRS. MOLD FLASH, PROTRUSIONS, OR GATE BURRS SHALL NOT EXCEED 0.15 PER SIDE. DIMENSION A.
5. OPTIONAL CONSTRUCTION: AN ADDITIONAL TRIMMED LEAD IS ALLOWED IN THIS LOCATION. TRIMMED LEAD NOT TO EXTEND MORE THAN 0.2 FROM BODY.

DIM	MILLIMETERS	
	MIN	MAX
A	3.00 BSC	
B	1.50 BSC	
C	0.90	1.10
D	0.25	0.50
G	0.95 BSC	
H	0.01	0.10
J	0.10	0.26
K	0.20	0.60
M	0° 10°	
S	2.50	3.00

SOLDERING FOOTPRINT*

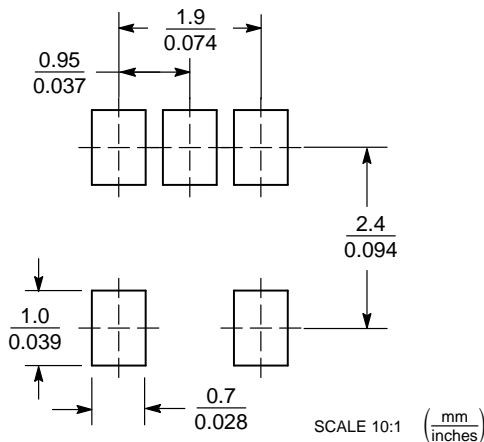

*For additional information on our Pb-Free strategy and soldering details, please download the ON Semiconductor Soldering and Mounting Techniques Reference Manual, SOLDERRM/D.

ON Semiconductor and the are registered trademarks of Semiconductor Components Industries, LLC (SCILLC) or its subsidiaries in the United States and/or other countries. SCILLC owns the rights to a number of patents, trademarks, copyrights, trade secrets, and other intellectual property. A listing of SCILLC's product/patent coverage may be accessed at www.onsemi.com/site/pdf/Patent-Marking.pdf. SCILLC reserves the right to make changes without further notice to any products herein. SCILLC makes no warranty, representation or guarantee regarding the suitability of its products for any particular purpose, nor does SCILLC assume any liability arising out of the application or use of any product or circuit, and specifically disclaims any and all liability, including without limitation special, consequential or incidental damages. "Typical" parameters which may be provided in SCILLC data sheets and/or specifications can and do vary in different applications and actual performance may vary over time. All operating parameters, including "Typicals" must be validated for each customer application by customer's technical experts. SCILLC does not convey any license under its patent rights nor the rights of others. SCILLC products are not designed, intended, or authorized for use as components in systems intended for surgical implant into the body, or other applications intended to support or sustain life, or for any other application in which the failure of the SCILLC product could create a situation where personal injury or death may occur. Should Buyer purchase or use SCILLC products for any such unintended or unauthorized application, Buyer shall indemnify and hold SCILLC and its officers, employees, subsidiaries, affiliates, and distributors harmless against all claims, costs, damages, and expenses, and reasonable attorney fees arising out of, directly or indirectly, any claim of personal injury or death associated with such unintended or unauthorized use, even if such claim alleges that SCILLC was negligent regarding the design or manufacture of the part. SCILLC is an Equal Opportunity/Affirmative Action Employer. This literature is subject to all applicable copyright laws and is not for resale in any manner.

PUBLICATION ORDERING INFORMATION

LITERATURE FULFILLMENT:

Literature Distribution Center for ON Semiconductor
19521 E. 32nd Pkwy, Aurora, Colorado 80011 USA
Phone: 303-675-2175 or 800-344-3860 Toll Free USA/Canada
Fax: 303-675-2176 or 800-344-3867 Toll Free USA/Canada
Email: orderlit@onsemi.com

N. American Technical Support: 800-282-9855 Toll Free
USA/Canada
Europe, Middle East and Africa Technical Support:
Phone: 421 33 790 2910
Japan Customer Focus Center
Phone: 81-3-5817-1050

ON Semiconductor Website: www.onsemi.com

Order Literature: <http://www.onsemi.com/orderlit>

For additional information, please contact your local Sales Representative