

# NPA 201-EV

## One of the World's Smallest I<sup>2</sup>C Pressure Sensor Evaluation Board (0.4" x 0.29")



### Description

The NPA 201-EV is a small and easy-to-use I<sup>2</sup>C Pressure Sensor evaluation board measuring 0.4"x0.29" and has standard 0.1in/2.54mm headers for easy use with a bread-board and is small enough to put right into an application. It is based on the Nova Sensor NPA 201 which comes in a 2.0x2.5x1.0 HCLGA style package. The NPA 201 can measure 260-1260 mBar absolute pressure range with 16bits of Resolution. Temperature measurement is also included. The NPA is operational from 3.14 to 3.46V and can operate across a -40°C to +85°C temperature range. The NPA 201 offers an ULTRA-LOW power SLEEP mode of ~20nA Typical and ACTIVE current is 35uA Typical.

The NPA 201 utilizes a **SIMPLE 3 Command I<sup>2</sup>C interface**(Command Request, Read Status, and Read Data). The NPA-201 is already calibrated, so there is no need for **REGISTER INITIALIZATION** needed. Upon Power Up the NPA 201 is ready to go as it is initialized internally.

The NPA 201-EV is compatible with the **Embedded Masters Rapid Prototyping Wireless Sensor Kit, EMSENSR-WSP** (Wireless Sensor Plugin) and **EMRF-WSB** (Wireless Sensor Base). The EMSENSR-WSP provides a Sensor Plugin platform that all EMSENSR's can be plugged into. The WSP can be directly connected to all of the Silicon Labs EFM32 Starter Kits on one side. The other side allows the EMSENSR- WSB to be connected to provide a BTLE connection using Broadcom based BTLE solutions.  
[www.embeddedmasters.com](http://www.embeddedmasters.com)

[NPA 201 Full Datasheet link:](#)

<http://www.amphenol-sensors.com/en/products/pressure-mems/mems-sensors/3236-npa-201>

[Gerber files and PCB Footprints are available upon request.](#)

# NPA 201-EV

## Table of Contents

Description .....	1
Features.....	2
I <sup>2</sup> C Commands .....	3
Schematics .....	4

---

## Features

- Simple 3 Command I<sup>2</sup>C Interface
- No Hardware Register Initialization
- VDD Supply Voltage 1.7 to 3.6 VDC
- 260 – 1260mBar Absolute Pressure Range
- Active Current (Typical @ 3V) = 35uA
- Sleep Current (Typical @ 3V) < 20nA Typ
- On-board 16bit Temperature Sensor: <0.003K/LSB
- 2ms Wake-up Time to Active Analog Operation
- Fully Calibrated and Compensated
- Up to 3.4MHz I<sup>2</sup>C Operation
- Internal 18bit DSP Running Correction Algorithm
- 0.4in x 0.29in Breakout Board with .1in/2.54mm Header Spacing that Can be Directly Soldered into a Prototype or Used with Breadboard. Headers are Spaced 0.4in Apart
- -40°C to +85°C Temperature Range

# NPA 201-EV I<sup>2</sup>C Commands

## I<sup>2</sup>C Commands

The NPA 201 utilizes an internal ASIC that initializes and calibrates the pressure sensor upon power-up. This allows for a SIMPLE I<sup>2</sup>C Command Set and avoids having to have the user initialize internal hardware registers on the NPA 201.

The I<sup>2</sup>C Command Set makes use of only 3 commands and are shown below. Each Command is started as shown in Figure 1. After the execution of a command (busy = 0) the expected data can be read as illustrated in Figure 3, or if not data is returned by the command the next command can be sent. The Status can be read at any time as described in Figure 2.

### 1. Command Request

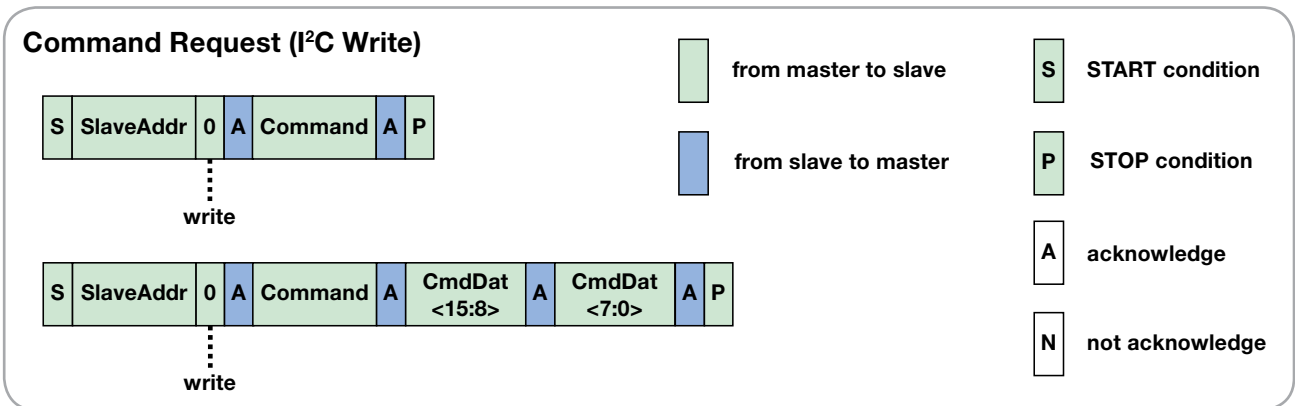

Figure 1 - I<sup>2</sup>C Command Request

### 2. Read Status

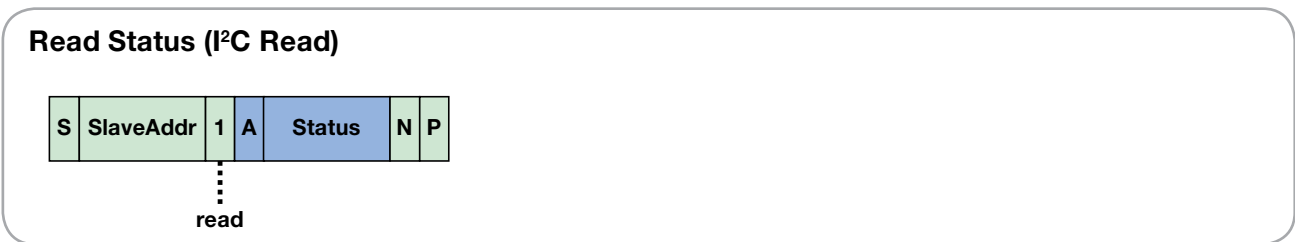

Figure 2 - I<sup>2</sup>C Read Status

### 3. Read Data

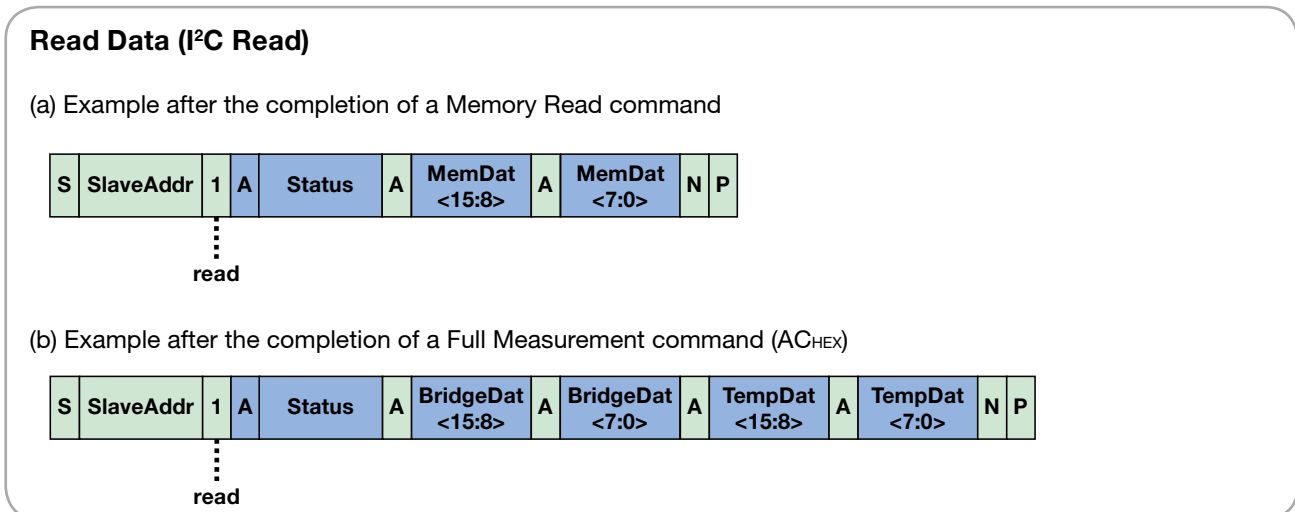
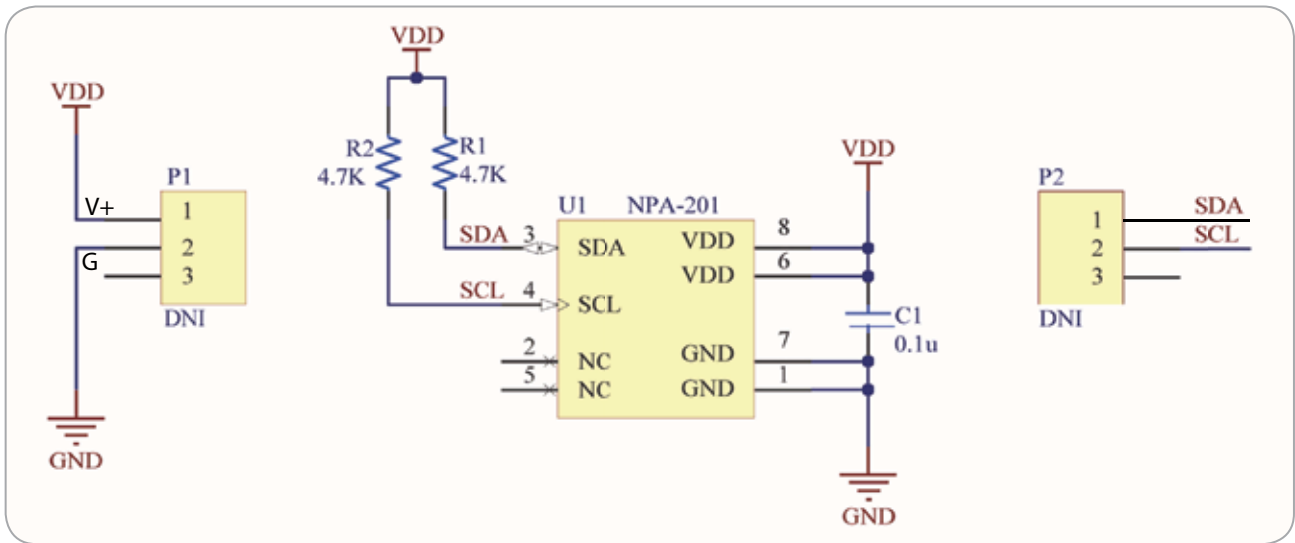
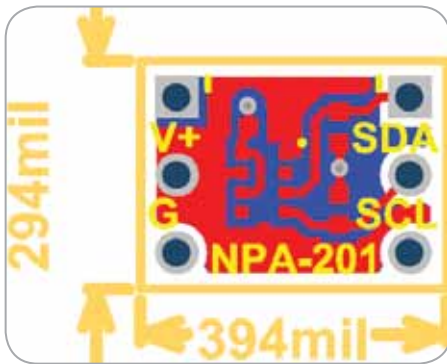

Figure 3 - I<sup>2</sup>C Read Data

# NPA 201-EV Schematics



NPA 201-EV Schematic



NPA 201-EV PCB - Top

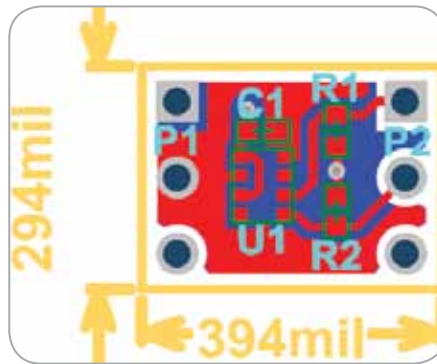

NPA 201-EV PCB - Designators

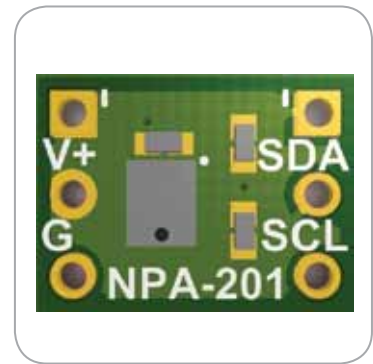

NPA 201-EV 3D PCB