

**KEMET Part Number: C0603C392K5RACTU**  
(C0603C392K5RAC7867)

SMD Comm X7R, Ceramic, 3900 pF, 10%, 50 V, X7R, SMD, MLCC, Temperature Stable, Class II, 0603

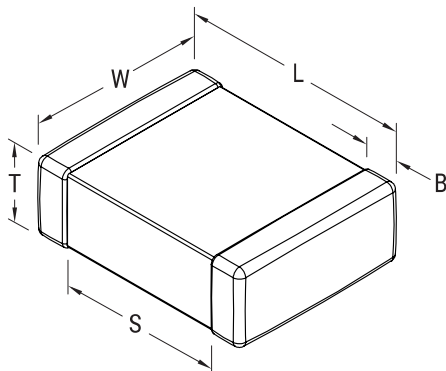

**Dimensions**

Dimensions	
<b>L</b>	1.6mm +/-0.15mm
<b>W</b>	0.8mm +/-0.15mm
<b>T</b>	0.8mm +/-0.07mm
<b>S</b>	0.7mm MIN
<b>B</b>	0.35mm +/-0.15mm

**Packaging Specifications**

<b>Packaging:</b>	T&R, 180mm, Paper Tape
<b>Packaging Quantity:</b>	4000

**General Information**

<b>Supplier:</b>	KEMET
<b>Series:</b>	SMD Comm X7R
<b>Style:</b>	SMD Chip
<b>Description:</b>	SMD, MLCC, Temperature Stable, Class II
<b>Features:</b>	Temperature Stable, Class II
<b>RoHS:</b>	Yes
<b>Termination:</b>	Tin
<b>Marking:</b>	No
<b>Failure Rate:</b>	N/A
<b>Miscellaneous:</b>	Note: Referee time for X7R dielectric for this part number is 1000 hours
<b>Chip Size:</b>	0603
<b>Shelf Life:</b>	78 Weeks
<b>MSL:</b>	1

**Specifications**

<b>Capacitance:</b>	3900 pF
<b>Capacitance Tolerance:</b>	10%
<b>Voltage DC:</b>	50 VDC
<b>Dielectric Withstanding Voltage:</b>	125 V
<b>Temperature Range:</b>	-55/+125C
<b>Temperature Coefficient:</b>	X7R
<b>Dissipation Factor:</b>	2.5% 1kHz 25C
<b>Aging Rate:</b>	3% Loss/Decade Hour
<b>Insulation Resistance:</b>	100 GOhms