

KEMET Part Number: C0603C473K5RACTU
(C0603C473K5RAC7867)

SMD Comm X7R, Ceramic, 0.047 uF, 10%, 50 V, X7R, SMD, MLCC, Temperature Stable, Class II, 0603

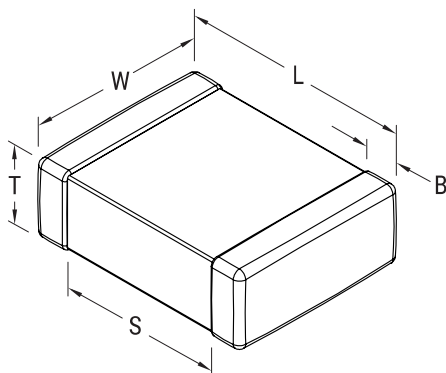

Dimensions

Dimensions	
L	1.6mm +/-0.15mm
W	0.8mm +/-0.15mm
T	0.8mm +/-0.15mm
S	0.7mm MIN
B	0.35mm +/-0.15mm

Packaging Specifications

Packaging:	T&R, 180mm, Paper Tape
Packaging Quantity:	4000

General Information

Supplier:	KEMET
Series:	SMD Comm X7R
Style:	SMD Chip
Description:	SMD, MLCC, Temperature Stable, Class II
Features:	Temperature Stable, Class II
RoHS:	Yes
Termination:	Tin
Marking:	No
Failure Rate:	N/A
Miscellaneous:	Note: Referee time for X7R dielectric for this part number is 48 hours
Chip Size:	0603
Shelf Life:	78 Weeks
MSL:	1

Specifications

Capacitance:	0.047 uF
Capacitance Tolerance:	10%
Voltage DC:	50 VDC
Dielectric Withstanding Voltage:	125 V
Temperature Range:	-55/+125C
Temperature Coefficient:	X7R
Dissipation Factor:	2.5% 1kHz 25C
Aging Rate:	3% Loss/Decade Hour
Insulation Resistance:	10 GOhms