

KEMET Part Number: C1206C221J5GACTU
(C1206C221J5GAC7800)

SMD Comm COG, Ceramic, 220 pF, 5%, 50 V, COG, SMD, MLCC, Ultra-Stable, Low Loss, Class I, 1206

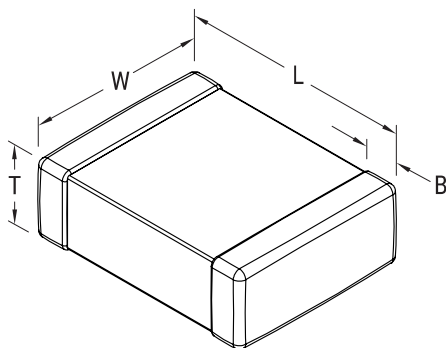

Dimensions

L	3.2mm +/-0.2mm
W	1.6mm +/-0.2mm
T	0.78mm +/-0.10mm
B	0.5mm +/-0.25mm

Packaging Specifications

Packaging:	T&R, 180mm, Plastic Tape
Packaging Quantity:	4000

General Information

Supplier:	KEMET
Series:	SMD Comm COG
Style:	SMD Chip
Description:	SMD, MLCC, Ultra-Stable, Low Loss, Class I
Features:	Ultra-Stable, Low Loss, Class I
RoHS:	Yes
Termination:	Tin
Marking:	No
Failure Rate:	N/A
Miscellaneous:	Note: KEMET 50V rated parts may be operated at 63 Volts
Chip Size:	1206
Shelf Life:	78 Weeks
MSL:	1

Specifications

Capacitance:	220 pF
Capacitance Tolerance:	5%
Voltage DC:	50 VDC
Dielectric Withstanding Voltage:	125 V
Temperature Range:	-55/+125C
Temperature Coefficient:	COG
Dissipation Factor:	0.1% 1MHz 25C
Aging Rate:	0% Loss/Decade Hour
Insulation Resistance:	100 GOhms