

KEMET Part Number: C1210C106K5RACTU
(C1210C106K5RAC7800)

SMD Comm X7R, Ceramic, 10 uF, 10%, 50 V, X7R, SMD, MLCC, Temperature Stable, Class II, 1210

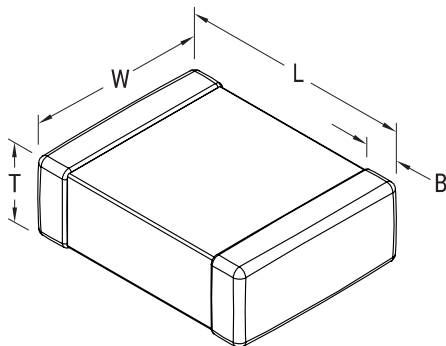

Dimensions	
L	3.2mm +/-0.3mm
W	2.5mm +/-0.22mm
T	2.5mm +/-0.30mm
B	0.5mm +/-0.25mm

Packaging Specifications	
Packaging:	T&R, 180mm, Plastic Tape
Packaging Quantity:	1000

General Information	
Supplier:	KEMET
Series:	SMD Comm X7R
Style:	SMD Chip
Description:	SMD, MLCC, Temperature Stable, Class II
Features:	Temperature Stable, Class II
RoHS:	Yes
Termination:	Tin
Marking:	No
Failure Rate:	N/A
Miscellaneous:	Note: Referee time for X7R dielectric for this part number is 48 hours
Chip Size:	1210
Shelf Life:	78 Weeks
MSL:	1

Specifications	
Capacitance:	10 uF
Capacitance Tolerance:	10%
Voltage DC:	50 VDC
Dielectric Withstanding Voltage:	125 V
Temperature Range:	-55/+125C
Temperature Coefficient:	X7R
Dissipation Factor:	2.5% 1kHz 25C
Aging Rate:	3% Loss/Decade Hour
Insulation Resistance:	10 MOhms