

2A Series

Sealed Sub-Miniature Toggle Switches

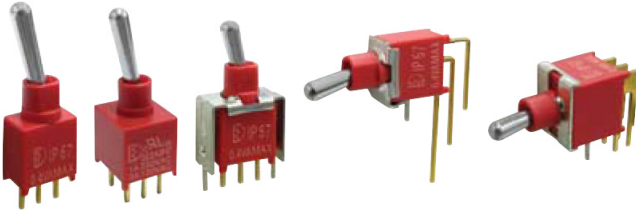

RoHS
Compliant



Specifications

Mechanical Life : 30,000 make-and-break cycles.
 Contact Resistance : 20mΩ max. initial @ 2-4V DC
 100mA for both silver and gold plated contacts
 Insulation Resistance : 1,000MΩ min.
 Dielectric Strength : 1,000 Vrms min. @ sea level
 Operating Temperature : -40°C to 85°C

Materials

Case and Bushing : Glass filled nylon 6/6, flame retardant, heat stabilized (UL94V-0)
 Actuator : Brass, Chrome plated, internal O-ring seal. Standard for all actuators
 Switch Support : Brass, Tin plated
 Contact / Terminals : Copper alloy with Silver or Gold plated

Contact Material Options

	Contact Plating	Terminal Plating	Ratings
Q	Silver	Q = Gold flash over silver	3 Amps with resistant load @ 120V AC or 28V DC 1 Amps with resistant load @ 250V AC
C	Gold over Silver	C = Gold over silver	
R	Gold	R = Gold	0.4 Volt - Amps (VA) max. @ 20V max. (AC or DC)

Switch Function

No. Poles	UL/CSA Model No.	Model No.	Switch Function			Connected Terminals / Schematic		
			Pos. 1	Pos. 2	Pos. 3	Pos. 1	Pos. 2	Pos. 3
SP	Q22A11	2AS1	ON	NONE	ON	2-3	N/A	2-1
	Q22A12	2AS2	ON	NONE	MOM		OPEN	
	Q22A13	2AS3	ON	OFF	ON			
	Q22A14	2AS4	MOM	OFF	MOM	OPEN	N/A	3-1
	Q22A15	2AS5	ON	OFF	MOM			
	Q22A16	2AS6	OFF	NONE	ON			
DP	Q22A21	2AD1	ON	NONE	ON	2-3, 5-6	N/A	2-1, 5-4
	Q22A22	2AD2	ON	NONE	MOM		OPEN	
	Q22A23	2AD3	ON	OFF	ON			

MOM = Momentary

www.element14.com
 www.farnell.com
 www.newark.com



2A Series

Sealed Sub-Miniature Toggle Switches



Pole Options

M2

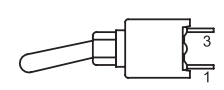
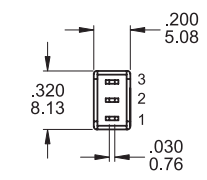
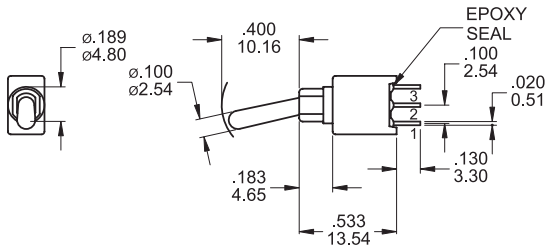

2AS6 Models : Omit 2nd terminal

P.C. Mounting

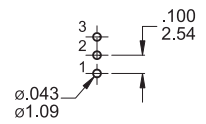

SPDT

M2

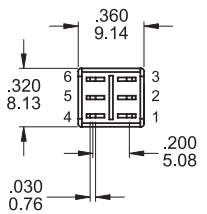
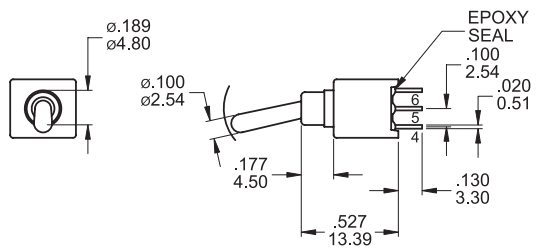

P.C. Mounting

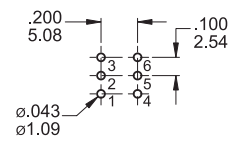

DPDT

Actuator Options

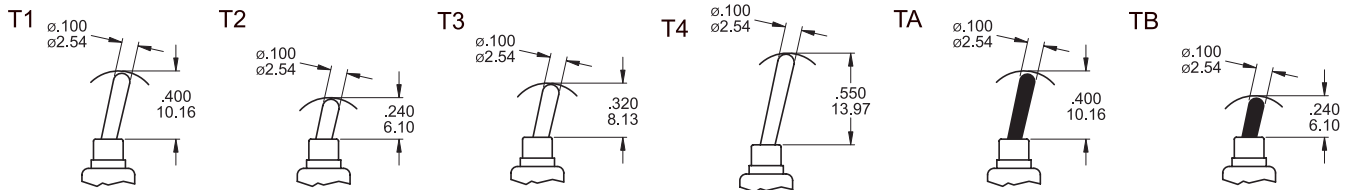

Actuator shown with A1 Bushing, sub 0.02" (0.5mm) for A3 Bushing.

Plastic Actuator

Bushing Options

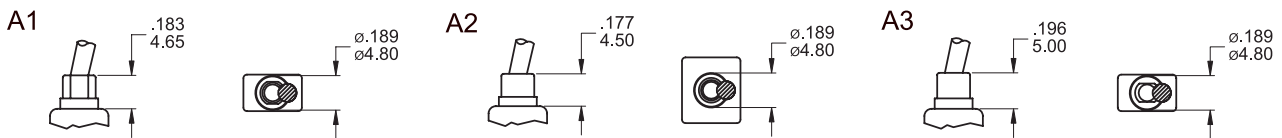

A1, A3 for SPDT / A2 for DPDT

Dimensions : Inches (Millimetres)



2A Series

Sealed Sub-Miniature Toggle Switches



Termination Options

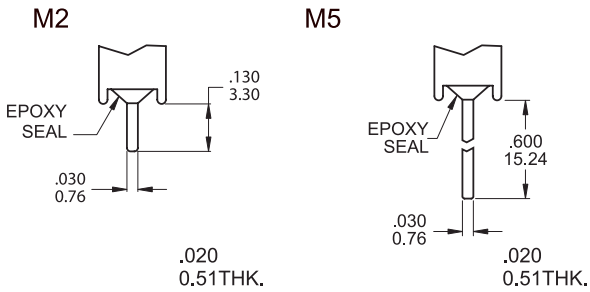

Other Termination Options

- M6 Right angle P.C. Mount
- M6N Right angle P.C. Mount Snap-in bracket
- M7 Vertical right angle P.C. Mount
- M7N Vertical right angle P.C. Mount Snap-in bracket
- VS2 Vertical bracket P.C. Mount

M6

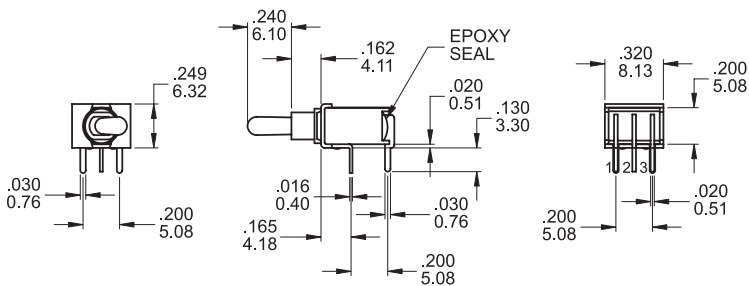

P.C. Mounting

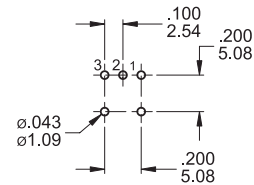

SPDT

M6

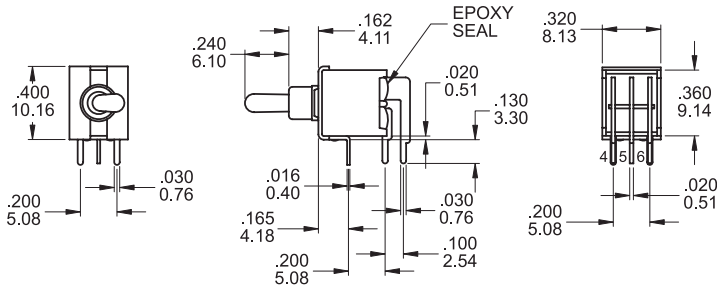

P.C. Mounting

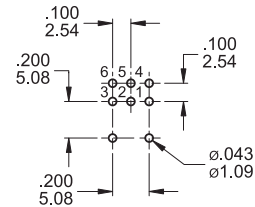

DPDT

M7

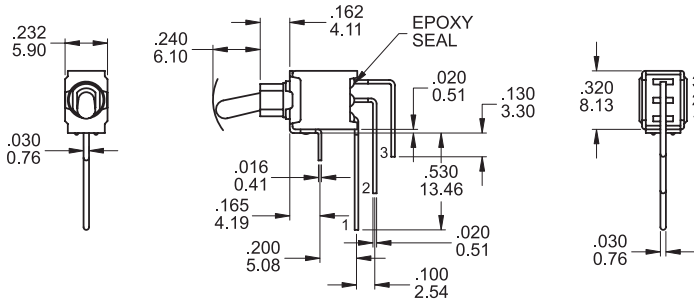

P.C. Mounting

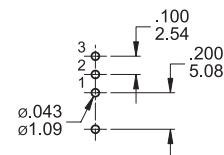

SPDT

Dimensions : Inches (Millimetres)

www.element14.com
www.farnell.com
www.newark.com



2A Series

Sealed Sub-Miniature Toggle Switches



M7

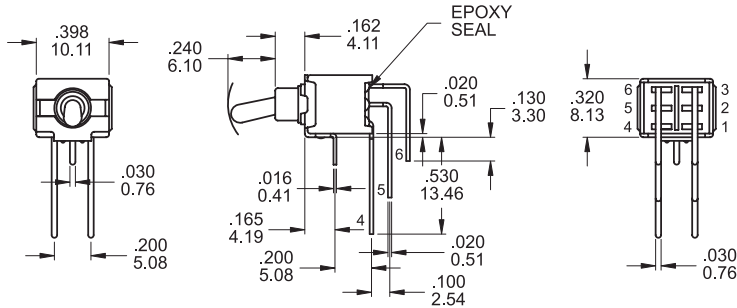

P.C. Mounting

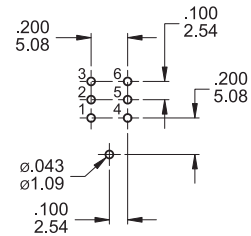

DPDT

VS2

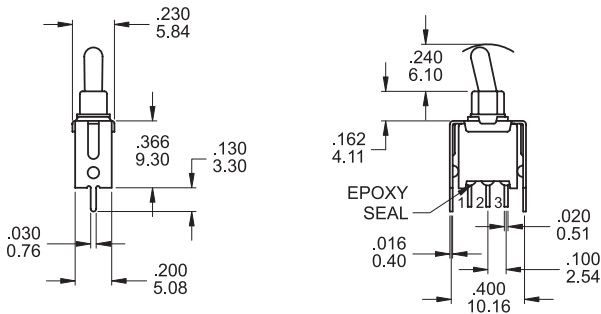

P.C. Mounting

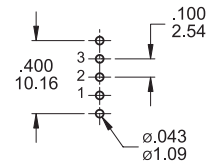

SPDT

VS2

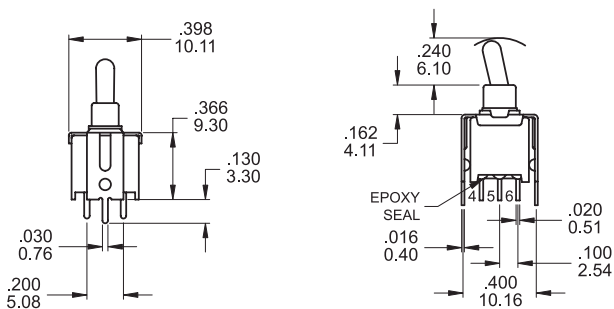

P.C. Mounting

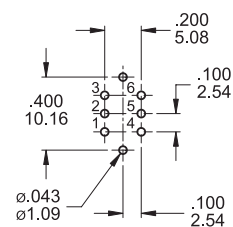

DPDT

Snap-in Termination Options

M6N

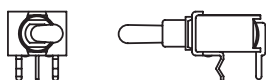

M7N

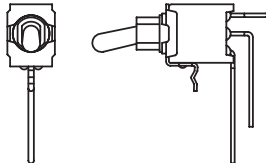

V2N

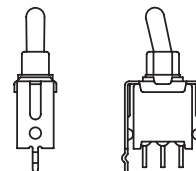

Dimensions : Inches (Millimetres)



2A Series

Sealed Sub-Miniature Toggle Switches



Soldering Processes

Manual Soldering : Use soldering iron of 30 watts, controlled at 350°C approximately 5 seconds while applying solder.

Wave Soldering : Recommended Soldering Temperature: 270 ± 5°C Duration of Solder Immersion: Max 5 sec.
(PCB is 1.6mm in thickness)

Part Number Explanation

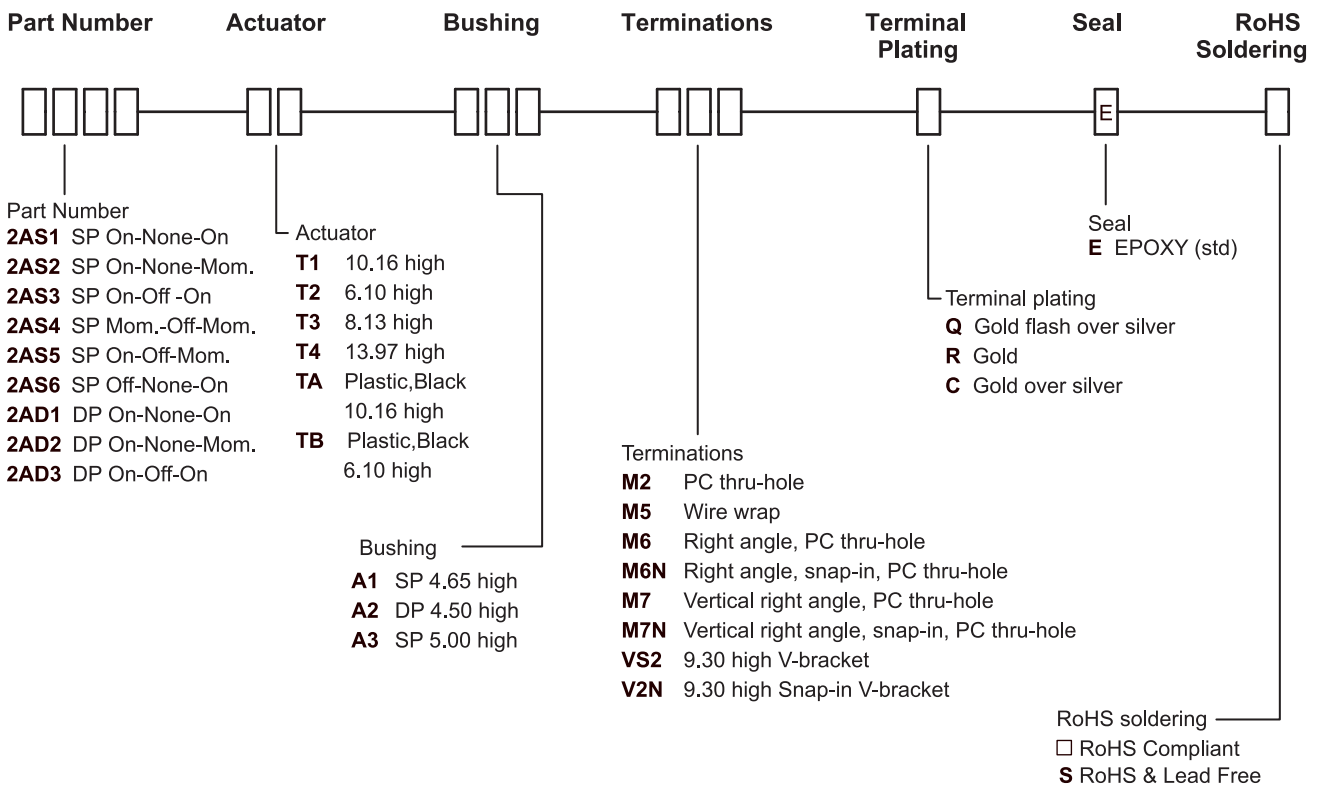

Important Notice : This data sheet and its contents (the "Information") belong to the members of the Premier Farnell group of companies (the "Group") or are licensed to it. No licence is granted for the use of it other than for information purposes in connection with the products to which it relates. No licence of any intellectual property rights is granted. The Information is subject to change without notice and replaces all data sheets previously supplied. The Information supplied is believed to be accurate but the Group assumes no responsibility for its accuracy or completeness, any error in or omission from it or for any use made of it. Users of this data sheet should check for themselves the Information and the suitability of the products for their purpose and not make any assumptions based on information included or omitted. Liability for loss or damage resulting from any reliance on the Information or use of it (including liability resulting from negligence or where the Group was aware of the possibility of such loss or damage arising) is excluded. This will not operate to limit or restrict the Group's liability for death or personal injury resulting from its negligence. Multicomp is the registered trademark of the Group. © Premier Farnell Limited 2016.

