

5065 Series 3/8" Wide Gap Press Fit Switch Sets

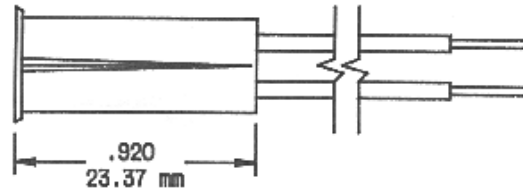

5066

- Lifetime Warranty
- 3/8" Press to Fit Switch with Terminals or Standard 12" Wire Leads
- UL Approved
- 1"+ Standard Gap
- Available in White (5065) UL Listed
- Available in Brown (5066)
- Supervisory Loops Available

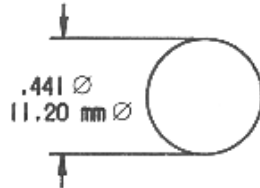

SWITCH

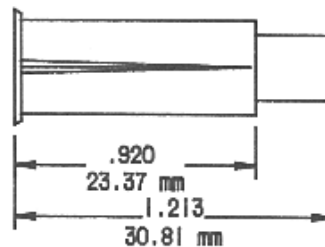
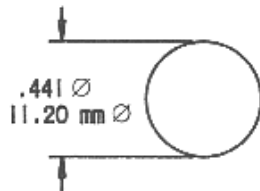

MAGNET

5065

RECESSED 3/8" SWITCH SET

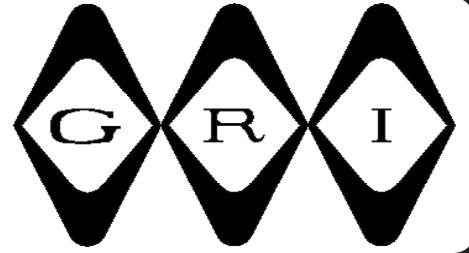

5065 SERIES

- ◆ One Inch Plus Standard Gap
 - ◆ 3/8" Diameter Press Fit
- ◆ Standard 12" Leads #22 AWG
- ◆ Available in White (P/N 5065) 
- ◆ Available in Brown (P/N/ 5066)

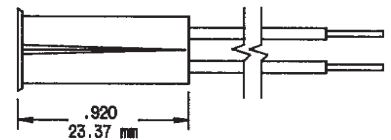
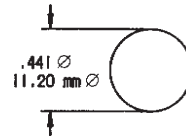

SWITCH

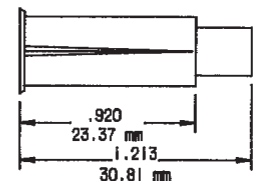
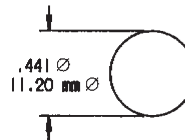

MAGNET

GRI products meet or exceed these minimum general specifications:

PART NUMBER	LOOP TYPE	ELECTRICAL CONFIG.	GAP	REED FORM	MAXIMUM INITIAL CONTACT RESISTANCE (Ω)	MAXIMUM CONTACT RATING (W)	MAXIMUM SWITCHING VOLTAGE (VDC)	MAXIMUM SWITCHING CURRENT (A)
5065	CLOSED	N/O	1" +	A	.150	10	200	.500
5066	CLOSED	N/O	1" +	A	.150	10	200	.500

WARRANTY

Lifetime warranty against workmanship, material and factory defects.

CONTACT YOUR G.R.I. DISTRIBUTOR OR CALL:

GEORGE RISK INDUSTRIES, INC.
G.R.I. PLAZA
KIMBALL, NE 69145



MADE IN U.S.A.

TOLL-FREE 1-800-445-5218
TOLL-FREE 1-800-523-1227
(308) 235-4645
FAX (308) 235-3561
E-MAIL: sales@grisk.com
WEB SITE: www.grisk.com

N SERIES SWITCH SETS



- ◆ Rare Earth Magnets Paired With Press To Fit Contacts
- ◆ Solves Problem Installs ◆ Time Saving Installations
- ◆ Nickel Plated To Protect From Chipping And Corrosion
- ◆ Use MM-600 With A Standard Gap Switch To Attain Wide Gap



N2120-12



N2020-TWG



N20RS-12

G.R.I.'s "Mighty Mag" contacts will assist in resolving the installer's problem of drilling into the new thinner vinyl windows. These rare earth magnets are less than 1/8" high and install fast and easily without worry about damage to the window itself. (Please see the Mighty Mag page in the accessories section of G.R.I.'s full line catalog for dimensions).

G.R.I.'s Mighty Magnets make use of a rare earth alloy which allows the size of the magnet to be significantly reduced while still retaining or improving the gap involved. These rare earth magnets can be mounted with the stainless steel mounting screws provided (MM-400 and MM-600) and/or double stick tape included in the bag, or may be glued into place.

Note: G.R.I. suggests using a silicone or clear nail polish sealant on the surface of installed rare earth magnets to prevent corrosion.

PART NUMBERS:

N120T-12	N2020-TWG	N2120-12WG	N50RF-12WG
N120T-12WG	N20RS-12	N4473	N50RS-12
N150-12	N20RS-12WG	N4473WG	N50RS-12WG
N150-12WG	N20RS-T	N50R-12	N5065
N2020-12	N20RS-TWG	N50R-12WG	
N2020-12WG	N2120-12	N50RF-12	

Other possible combinations including Open Loop and S.P.D.T. available or as Switch Only and Magnet Only.

GEORGE RISK INDUSTRIES, INC.
G.R.I. PLAZA
KIMBALL, NE 69145



TOLL-FREE 1-800-445-5218
TOLL-FREE 1-800-523-1227
(308) 235-4645
FAX (308) 235-3561
E-MAIL: sales@grisk.com
WEB SITE: www.grisk.com



SWITCHES WITH RARE EARTH MAGNETS

Pair Switch with Magnet to get the following gaps:

Switch	Description	MM-25 MMR-25	MM-375	MM-10	MM-400	MM-600	MMF-875
S120T-12	3/4" Press Fit/Leads	3/8"+	1"+	Up to 1"	Up to 3/4"	1"+	3/4"+
S150-12	1/2" Press Fit/Leads	1/2"+	1 1/2"+	Up to 1"	3/4"+	1 1/2"+	1"+
S2020-12	3/8" Press Fit/Leads	Up to 1/2"	1"+	Up to 1"	1"+	1"+	1"
S2020-T	3/8" Press Fit/Terminals	3/8"+	1"+	Up to 1"	Up to 3/4"	1"+	1/2"+
S20RS-12	3/8" Short Press Fit/Leads	Up to 3/8"	1"+	3/4"+	Up to 3/4"	Up to 1"	3/4"
S20RS-T	3/8" Short Press Fit/Terminals	3/8"+	1"+	3/4"+	Up to 3/4"	Up to 1"	3/4"
S2120-12	3/8" Ribbed Press Fit/Leads	5/8"+	1"+	Up to 1"	Up to 3/4"	1"+	3/4"+
S4473	3/4" Press Fit/Terminals	Up to 1/2"	1 1/4"+	Up to 1"	Up to 3/4"	1"+	3/4"+
S50R-12	1/4" Press Fit/Leads	Up to 1/2"	Up to 1 1/2"	1"+	3/4"+	Up to 1 1/4"	3/4"+
S50RF-12	1/4" Press Fit/Flanged/Leads	Up to 1/2"	Up to 1 1/2"	1"+	Up to 3/4"	Up to 1 1/4"	1"
S50RS-12	1/4" Short Press Fit/Leads	Up to 3/8"	1"+	3/4"+	Up to 1/2"	Up to 1 1/4"	3/4"
S5065	3/8" Press Fit/Leads	1/2"+	1"+	1"+	Up to 1"	Up to 1 1/4"	1/2"+

Magnet orientation will affect operation of switch. Please confirm operation prior to installation.

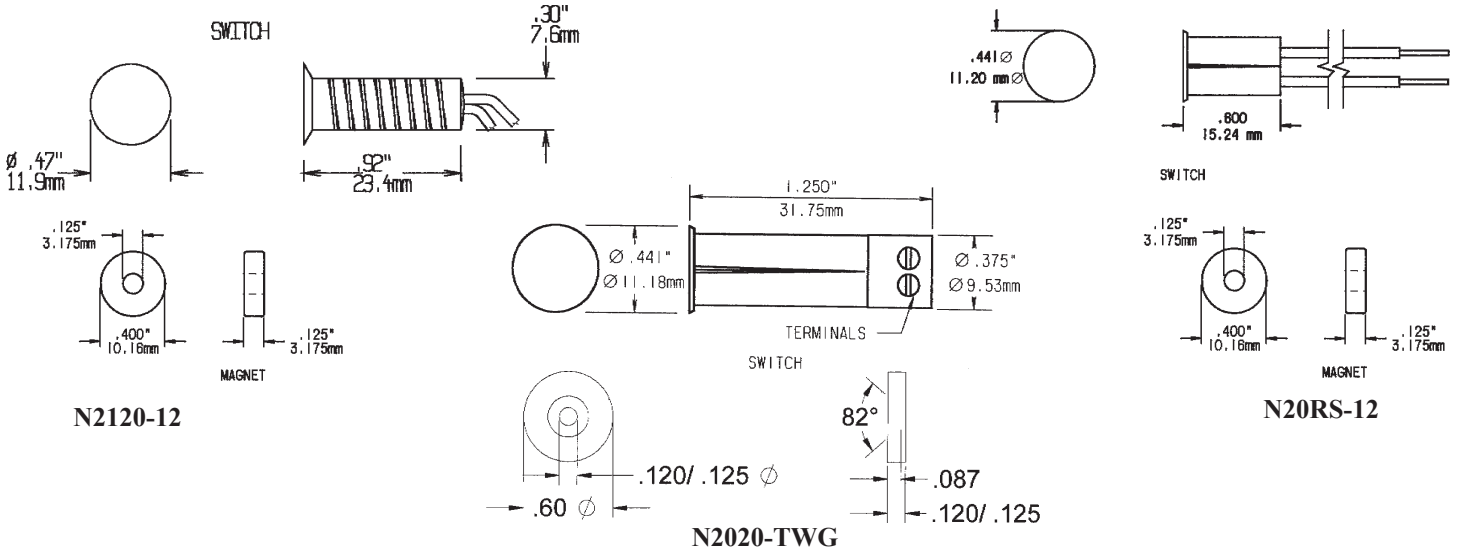

WARRANTY:

Lifetime warranty against workmanship, material and factory defects.

CONTACT YOUR G.R.I. DISTRIBUTOR OR CALL:

GEORGE RISK INDUSTRIES, INC.
G.R.I. PLAZA
KIMBALL, NE 69145



MADE IN U.S.A.

TOLL-FREE 1-800-445-5218
TOLL-FREE 1-800-523-1227
(308) 235-4645
FAX (308) 235-3561
E-MAIL: sales@grisk.com
WEB SITE: www.grisk.com