

Enclosed Changeover Switch



Features

- Under load operation
- Earth terminal included
- Captive \pm terminal screws
- Pad lockable in OFF position (up to 3 padlocks)
- Lid interlocked with switch in position 1 and 2
- IP65 rating in all the enclosures
- Manufactured to IEC60947-3

Electrical Ratings (According to IEC 60947-3)

AC Rated thermal current I_{th} (40°C) : 63A
 Rated insulation voltage U_i (V) : 690
 Rated impulse withstand voltage U_{imp} (kV) : 8

AC Rated operational current I_e (A)

Rated voltage	Utilization category	I_e
415V AC	AC22A	63A

Connection Capacity

Rigid cable (Cu) mm² : 16/25
 Flexible cable (Cu) mm² : 10/16

Standards

IEC 60947-3

Approvals

CE, UL listed, Bureau Veritas

Dimensions

180mm × 182mm × 137mm

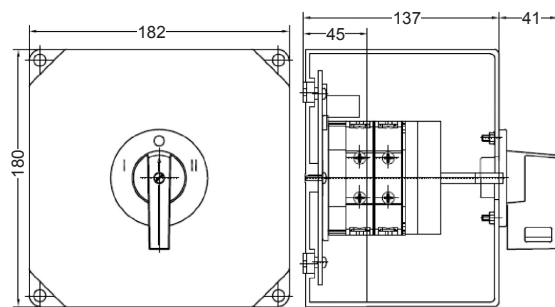

Dimensions : Millimetres

Electrical Drawing

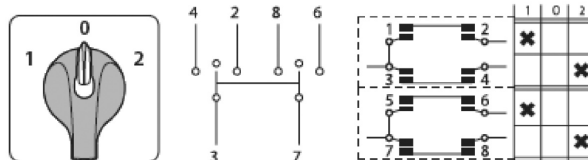

Part Number Table

Description	Part Number
2 Pole Changeover Switch, 63A	MCLBC632P

Important Notice : This data sheet and its contents (the "Information") belong to the members of the Premier Farnell group of companies (the "Group") or are licensed to it. No licence is granted for the use of it other than for information purposes in connection with the products to which it relates. No licence of any intellectual property rights is granted. The Information is subject to change without notice and replaces all data sheets previously supplied. The Information supplied is believed to be accurate but the Group assumes no responsibility for its accuracy or completeness, any error in or omission from it or for any use made of it. Users of this data sheet should check for themselves the Information and the suitability of the products for their purpose and not make any assumptions based on information included or omitted. Liability for loss or damage resulting from any reliance on the Information or use of it (including liability resulting from negligence or where the Group was aware of the possibility of such loss or damage arising) is excluded. This will not operate to limit or restrict the Group's liability for death or personal injury resulting from its negligence. Multicomp is the registered trademark of the Group. © Premier Farnell Limited 2016.

www.element14.com
 www.farnell.com
 www.newark.com