

KEMET Part Number: C0603C222J5GACTU
(C0603C222J5GAC7867)

SMD Comm COG, Ceramic, 2200 pF, 5%, 50 V, COG, SMD, MLCC, Ultra-Stable, Low Loss, Class I, 0603

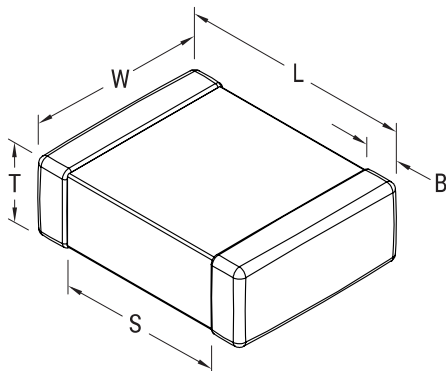

Dimensions

Dimensions	
L	1.6mm +/-0.15mm
W	0.8mm +/-0.15mm
T	0.8mm +/-0.07mm
S	0.7mm MIN
B	0.35mm +/-0.15mm

Packaging Specifications

Packaging:	T&R, 180mm, Paper Tape
Packaging Quantity:	4000

General Information

Supplier:	KEMET
Series:	SMD Comm COG
Style:	SMD Chip
Description:	SMD, MLCC, Ultra-Stable, Low Loss, Class I
Features:	Ultra-Stable, Low Loss, Class I
RoHS:	Yes
Termination:	Tin
Marking:	No
Failure Rate:	N/A
Miscellaneous:	Note: KEMET 50V rated parts may be operated at 63 Volts
Chip Size:	0603
Shelf Life:	78 Weeks
MSL:	1

Specifications

Capacitance:	2200 pF
Capacitance Tolerance:	5%
Voltage DC:	50 VDC
Dielectric Withstanding Voltage:	125 V
Temperature Range:	-55/+125C
Temperature Coefficient:	COG
Dissipation Factor:	0.1% 1kHz 25C
Aging Rate:	0% Loss/Decade Hour
Insulation Resistance:	100 GOhms