

**KEMET Part Number: C1206C150J5GACTU**  
(C1206C150J5GAC7800)

SMD Comm COG, Ceramic, 15 pF, 5%, 50 V, COG, SMD, MLCC, Ultra-Stable, Low Loss, Class I, 1206

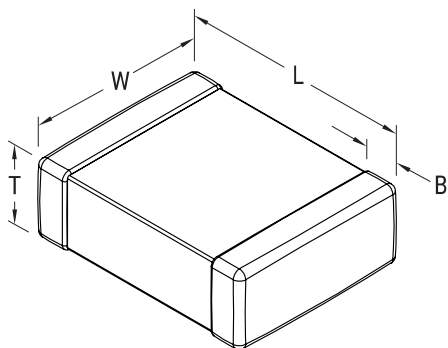

**Dimensions**

<b>L</b>	3.2mm +/-0.2mm
<b>W</b>	1.6mm +/-0.2mm
<b>T</b>	0.78mm +/-0.10mm
<b>B</b>	0.5mm +/-0.25mm

**Packaging Specifications**

<b>Packaging:</b>	T&R, 180mm, Plastic Tape
<b>Packaging Quantity:</b>	4000

**General Information**

<b>Supplier:</b>	KEMET
<b>Series:</b>	SMD Comm COG
<b>Style:</b>	SMD Chip
<b>Description:</b>	SMD, MLCC, Ultra-Stable, Low Loss, Class I
<b>Features:</b>	Ultra-Stable, Low Loss, Class I
<b>RoHS:</b>	Yes
<b>Termination:</b>	Tin
<b>Marking:</b>	No
<b>Failure Rate:</b>	N/A
<b>Miscellaneous:</b>	Note: KEMET 50V rated parts may be operated at 63 Volts
<b>Chip Size:</b>	1206
<b>Shelf Life:</b>	78 Weeks
<b>MSL:</b>	1

**Specifications**

<b>Capacitance:</b>	15 pF
<b>Capacitance Tolerance:</b>	5%
<b>Voltage DC:</b>	50 VDC
<b>Dielectric Withstanding Voltage:</b>	125 V
<b>Temperature Range:</b>	-55/+125C
<b>Temperature Coefficient:</b>	COG
<b>Dissipation Factor:</b>	0.1% 1MHz 25C
<b>Aging Rate:</b>	0% Loss/Decade Hour
<b>Insulation Resistance:</b>	100 GOhms