

NOTE



All numerical values are in metric units [with U.S. customary units in brackets]. Dimensions are in millimeters [and inches]. Unless otherwise specified, dimensions have a tolerance of ± 0.13 [$\pm .005$] and angles have a tolerance of $\pm 2^\circ$. Figures and illustrations are for identification only and are not drawn to scale.



A In the event that there are difference between the information presented in this application specification versus the information found in other instruction material, this application specification will take precedence.

1. INTRODUCTION

This specification covers the requirements for application of DEUTSCH size 20 S&F pin and socket contacts. These contacts are used in any DEUTSCH connector having size 20 contact cavities. Each contact features a wire barrel, insulation barrel, retention shoulder, and mating end. The socket features a protective sleeve. In use, the retention shoulder holds the contact in the connector. The contacts are available in loose-piece and strip-fed form for terminating using a hand tool or automatic machine.

When corresponding with personnel, use the terminology provided in this specification to facilitate inquiries for information. Basic terms and features of this product are provided in Figure 1.

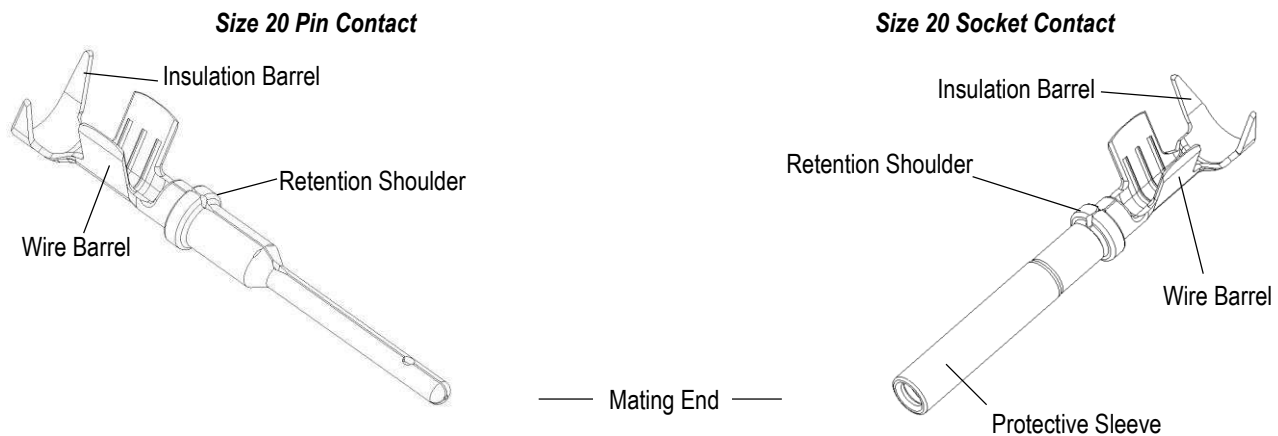

Figure 1

2. REFERENCE MATERIAL

2.1. Revision Summary

See section 7

2.2. Customer Assistance

Product Base Part Numbers (listed below) and Product Code J837 are representative of DEUTSCH size 20 S&F pin and socket contacts. Use of these numbers will identify the product line and help you to obtain product and tooling information. Such information can be obtained by visiting our website at www.te.com or calling the number at the bottom of this page.

Pin:	1060-20-01	1060-20-02	1060-20-06	
Socket:	1062-20-01	1062-20-02	1062-20-03	1062-20-06

2.3. Drawings

Customer drawings for product part numbers are available from www.te.com. The information contained in the customer drawings takes priority.

2.4. Instructional Material

Instructional material that pertains to this product are:

- 402-1002 Interpretation of Cross-Sections for F-Crimp
- 408-3295 Preparing Reel of Contacts for Application Tooling
- 408-7424 Checking Terminal Crimp Height and Gaging the Die Closure
- 408-9816 Handling of Reeled Product
- 408-10389 Ocean Side-Feed Applicators
- 408-151007 DEUTSCH Extraction Tools for Rear-Release Connectors
- 408-151008 DEUTSCH Removal Tool DT-RT1 for Front-Release Connectors
- 409-5128 Basic AMP-O-LECTRIC* Model "K" Terminating Machines 471273-[]
- 409-5207 Model "T" Terminating Units 694620-[]
- 409-5289 Model "T" Terminating Unit 458000-4
- 409-5842 AMP-O-LECTRIC Model "G" Terminating Machines 354500-[]
- 409-10047 AMP 3K* Terminating Machines 1725950-[] and AMP 5K* Terminating Machines 1725900-[]
- 409-10099 AMP 3K/40* Terminating Machines 2116983-[] and AMP 5K/40* Terminating Machines 2116984-[]
- 114-18022-10 Making and evaluation of Cross section for F-Crimp Termination
- 0425-032-0000 Applicator DCT20-02-00
- 0425-060-0000 Applicator DCT1620-02-00
- 0425-072-0000 Hand Crimping Tool DTT-20-00
- 0425-073-0000 Hand Crimping Tool DTT-20-02
- 0425-076-0000 Hand Crimping Tool DTT-20-03

2.5. Global Standards and Publications

DIN 72551-6, "Road Vehicles—Low-Tension Cables—Part 6: Single-Core, Unscreened with Thin Insulation Wall; Dimensions, Materials, Marking"

ISO 6722, "Road Vehicles—60 V and 600 V Single-Core Cables—Dimensions, Test Methods, and Requirements"

SAE J1128, "Low Voltage Primary Cable"

3. REQUIREMENTS

3.1. Storage

A. Ultraviolet Light

Prolonged exposure to ultraviolet light may deteriorate the chemical composition used in the product material.

B. Shelf Life

The product should remain in the shipping containers until ready for use to prevent deformation to components. The product should be used on a first in, first out basis to avoid storage contamination that could adversely affect performance.

C. Reeled Contacts

When using reeled contacts, store coil wound reels horizontally and traverse wound reels vertically.

D. Chemical Exposure

Do not store product near any chemical listed below as they may cause stress corrosion cracking in the material.

Alkalies	Ammonia	Citrates	Phosphates	Citrates	Sulfur Compounds
Amines	Carbonates	Nitrites	Sulfur Nitrites		Tartrates

3.2. Operating Temperature

These contacts are designed to operate in a temperature range of -55 to 125°C [-67 to 257°F].

3.3. Material

The contacts are made of copper alloy. Plating material is provided on the contact-specific customer drawing.

3.4. Wire Size and Preparation

The contacts accept stranded wire sizes and insulation diameters given in Figure 2. For insulation diameter per contact, refer to the customer drawing for the contact. The wire must be stripped within the dimensions given in Figure 2. Special wire type which may require special applicator tooling settings, crimp requirements are not covered in this specification.



CAUTION

The wire conductors and insulation must not be nicked, scrapped, broken, or cut during the stripping operation.

WIRE RANGE	INSULATION DIAMETER RANGE		Note: Not to Scale
0.35-2.50 mm ² , 22-14 AWG	1.91-3.18 [.075-.125]		
0.35-1.50 mm ² , 22-16 AWG	1.30-2.16 [.051-.085]		

Figure 2

3.5. Crimp

The contact must be crimped to the wire according to instructions packaged with the tooling. These requirements apply equally to the pin contact and the socket contact. It is essential to have the applicator feeding mechanism adjusted correctly to ensure the contact is positioned centered on the crimp anvil. Refer to the applicator instruction sheet for adjustment instructions.

A. Cutoff Tab

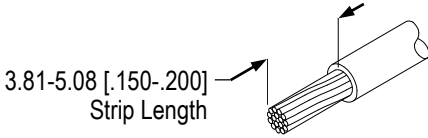
The cutoff tab is considered the remaining portion of the carrier strip after the contact is cut from the strip. The cutoff tab must not exceed the dimension given in Figure 3.

B. Wire Barrel Seam

The wire barrel crimp must form a closed seam over the entire length of the wire barrel. Refer to Figure 3.

C. Wire Barrel Crimp

The crimp applied to the wire barrel portion of the contact must be the most compressed area. All conductors within the wire barrel crimp must show evidence of compression. Good compression is guaranteed by following the given crimp dimensions, Figure 3. The crimp barrel is filled with the

conductor strands. All conductor strands within the wire crimp must show evidence of compression. Voids due to unequal roll-in of the crimp barrel legs, uneven distribution of strands or unfavorable tolerance set of wire cross section area, crimp height and material thickness, are permissible. The crimped area must be symmetrical on both sides of the wire barrel. The thickness of the wall must be uniform. See 114-18022-10 for more information how to make and evaluate F-crimp cross sections.

The crimp barrel inside wall is formed to the shape of the strands for an intimate contact. All existing wire strands are enclosed within the wire barrel. Any stranding outside the crimp barrel or broken strands outside the wire crimp are not permissible.

If low compression occurs, the number of strands has to be checked. To avoid over compression, which would favor wire barrel flash, the wire crimp height may not be beyond the limitation.

All conductors must be centered within and held firmly inside the wire barrel. No strands can be folded back over the wire insulation. There must be no evidence of loose wire strands or wire strands visible in the seam. The wire insulation must not enter the contact wire barrel. Refer to Figure 3.

For wire sizes 18AWG, the crimp is acceptable when each tip of the wire barrel wraps inward to form a curl that touches the inside of the wire barrel. See Figure 3.

The wire barrel crimp height and width must be within the dimensions provided in Figure 3.

D. Insulation Barrel Crimp

The insulation barrel shall not have burrs. The insulation barrel crimp shall grip the wire insulation firmly. The insulation barrel crimp (including the cutoff tab) must be equal to or less than the wire insulation outside diameter.

The wire stripping tool may leave corrugated indentations on the surface of the wire insulation. This is especially severe with cross-linked polyethylene (high-temperature) wire insulation. If the wire is positioned with these indentations at the connector wire seal, leakage may result. The wire insulation surface must be smooth and free of indentations within the area described in Figure 3.

There may be a slight deformation of the wire insulation. There may be skewing of the wire insulation.

Crimp Requirements

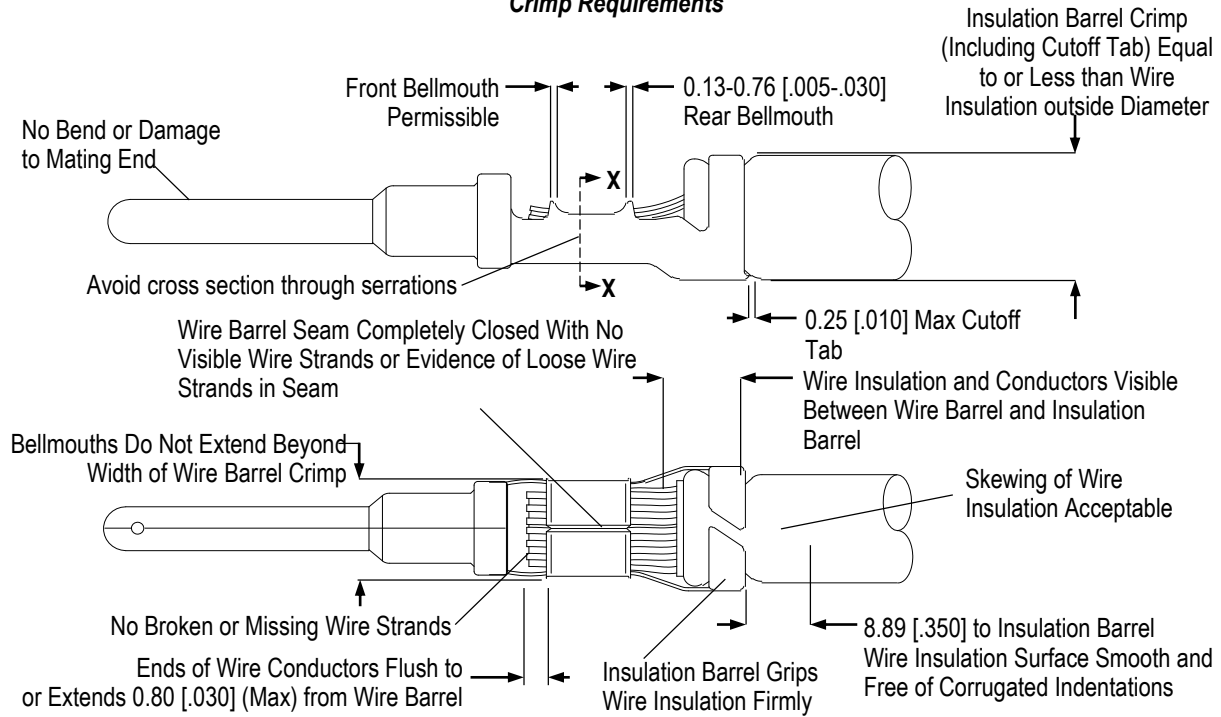

Wire size 1.5 mm² Thick Shown

Wire size 0.35 mm² Thin Shown

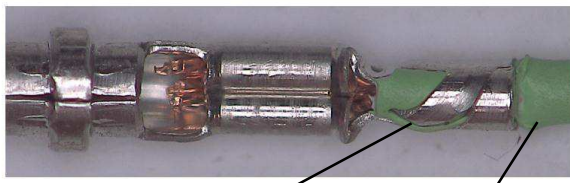
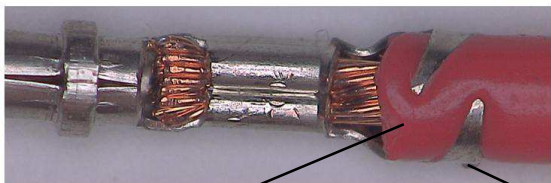

Slight Deformation of Wire Insulation Acceptable

Skewing of Wire Insulation Acceptable

Skewing of Wire Insulation Acceptable

Slight Deformation of Wire Insulation Acceptable

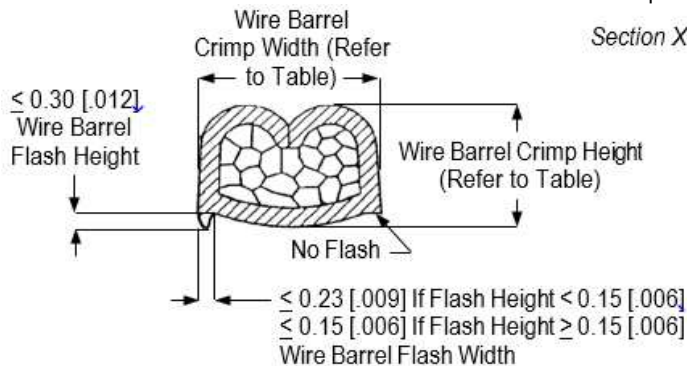

Section X-X

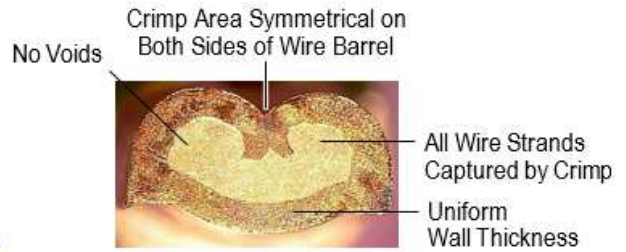
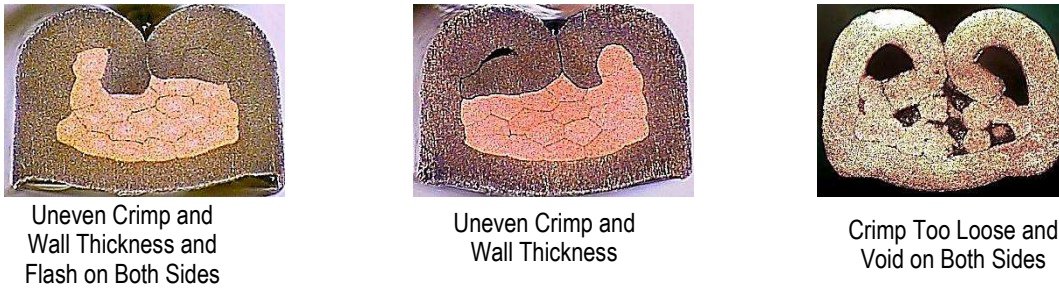

Figure 3 (Cont'd)

Section X-X for Wire Size ≤ 18 AWG



Unacceptable Wire Barrel Crimp



Contact 1060 (Pin); 1062 (Socket)	Wire Size	Wire Insulation Diameter Range	Contact Wire Barrel	
			Crimp Height	Crimp Width
1060-20-01 1062-20-01 1062-20-03	1.50mm ²	1.91-3.18 [.075-.125]	1.42-1.50 [.056-.059]	1.80-1.98 [.071-.078]
	16 AWG		1.22-1.30 [.048-.051]	1.80-1.96 [.071-.077]
	1.00mm ²		1.22-1.30 [.048-.051]	
	18 AWG		1.19-1.27 [.047-.050]	
	0.75 mm ²		1.17-1.25 [.046-.049]	
	0.60mm ²		1.02-1.10 [.040-.043]	
	20 AWG		0.94-1.02 [.037-.040]	
	0.50 mm ²		0.92-1.00 [.036-.039]	
	22 AWG		0.89-0.97 [.035-.038]	
	0.35 mm ²		0.89-0.97 [.035-.038]	
1060-20-02 1062-20-02	1.50mm ²	1.30-2.16 [.051-.085]	1.42-1.50 [.056-.059]	1.80-1.98 [.071-.078]
	16 AWG		1.22-1.30 [.048-.051]	1.80-1.96 [.071-.077]
	1.00mm ²		1.22-1.30 [.048-.051]	
	18 AWG		1.19-1.27 [.047-.050]	
	0.75mm ²		1.17-1.25 [.046-.049]	
	0.60mm ²		1.02-1.10 [.040-.043]	
	20 AWG		0.94-1.02 [.037-.040]	
	0.50mm ²		0.92-1.00 [.036-.039]	
	22 AWG		0.89-0.97 [.035-.038]	
	0.35mm ²		0.89-0.97 [.035-.038]	

1060-20-06 1062-20-06	2.50mm ²	1.91-3.18 [.075-.125]	1.63-1.71 [.064-.067]	1.88-2.04 [.074-.080]
	14 AWG		1.60-1.68 [.063-.066]	
	1.50mm ²		1.55-1.63 [.061-.064]	1.85-2.01 [.073-.079]
	16 AWG		1.50-1.58 [.059-.062]	
	1.00mm ²		1.50-1.58 [.059-.062]	

Figure 3 (End)

E. Bellmouths

A front bellmouth is permissible. The rear bellmouth shall conform to the dimensions given in Figure 3.

F. Wire Conductor and Insulation Location

The wire conductor and insulation must be visible between the contact wire barrel and insulation barrel. Conductor ends must be flush with or extend beyond the end of the wire barrel to the dimension given in Figure 3.

G. Wire Barrel Flash

Wire barrel flash is the formation that may appear on one side of the wire barrel as the result of the crimping process. It must not exceed the dimension provided in Figure 3.

There must be no cracking at the bottom of the wire barrel—independent of the size of the flash.

H. Mating End

The mating end of the contact must not be bent or damaged in any way. See Figure 3.

I. Bend Allowance

The force applied during crimping may cause some bending between the crimped wire barrel and the mating portion of the contact. Such deformation is acceptable within the limits provided in Figure 4.

The up-and-down bend of the crimped portion of the contact, including the cutoff tab and burr, and the side-to-side bend of the crimped contact must not be bent beyond the limits given.



NOTE

1. Periodic inspections must be made to ensure crimped contact formation is consistent.
2. Periodic inspection of applicator tooling must be made to ensure parts are tightened in the correct position.
3. Perform regular maintenance and tool wear inspection. See applicator instruction sheet for more information.

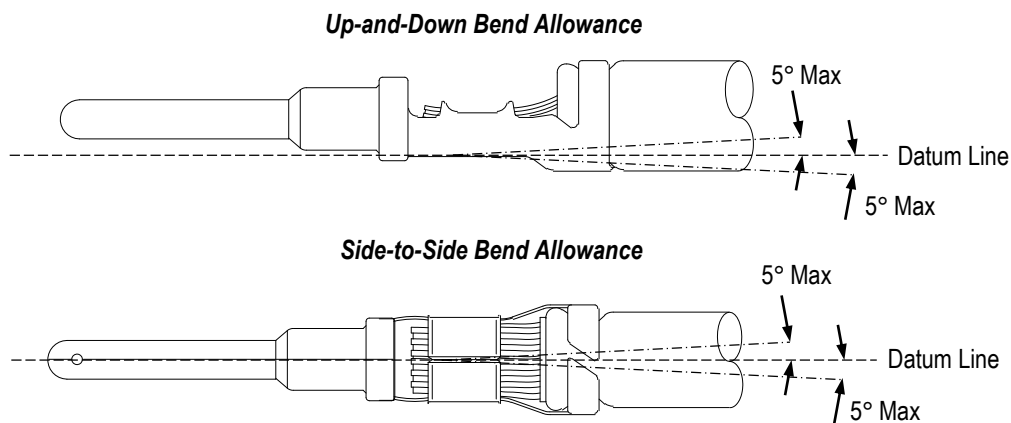

Figure 4

3.6. Processing

Care must be taken when transporting, storing, or processing crimped contacts and wires that any damage or soiling of the contact body or crimped area is avoided. When processing the end of the wire or anywhere along the wire, damage or impairment of the crimped contact must be avoided.

For a twisting operation after crimping or inserting a contact to a connector, the twist must end at least 35 [1.38] away from the contact. Additional care must be taken during or after the twisting operation to avoid any pulling force to the contact or crimped area that may affect the function of the connector.

TE has not tested, nor otherwise verified, contact performance after processing of the connected wire by ultrasonic welding. TE does not make any representation or warranty, expressed or implied, and disclaims any and all liability, on any legal basis whatsoever, for contact performance after ultrasonic welding of the connected wire. Customer takes sole responsibility for the evaluation, application, and use of contacts in such circumstances.

3.7. Replacement and Repair

Damaged or worn contacts cannot be repaired. A contact can be replaced provided there is sufficient slack to insert the new contact into the connector. An extraction tool must be used to remove individual contacts from the connector.

4. QUALIFICATION

DEUTSCH size 20 S&F pin and socket contacts do not require agency approval.

5. TOOLING

Tooling part numbers and related instructional material are given in Figure 5.

5.1. Hand Tools

The hand crimping tools consist of a handle assembly with integral fixed crimping dies. The dies have crimping chambers used to crimp the contact onto pre-stripped wire.

5.2. Applicators

The applicators are designed to crimp strip-fed contacts onto pre-stripped wire, and provides for high volume, heavy duty production requirements. These applicators accept interchangeable crimping dies and must be installed onto a power unit.

5.3. Power Units

These power units provide the force required to drive applicators. They provide for high volume, heavy duty production requirements. All of the power units are stand-alone machines; except the basic AMP-O-ELECTRIC Model "K", which is designed to be bench mounted.

5.4. Extraction Tools and Removal Tool

The extraction tools and removal tool are designed to remove the contacts from the connectors by releasing the contact retention fingers from the housing without overstressing any part of the contact.

5.5. Crimping Dies

The dies are designed to be installed into an applicator. The dies form the crimp when crimping the contact.

5.6. Micrometer

A micrometer should be used to measure contact crimp height.



Ocean Side-Feed Applicators
(408-10389)



DEUTSCH Applicator
DCT20-02-00
(0425-207-0000)



DEUTSCH Applicator
DCT1620-02-00
(0425-060-000)

*Crimping Dies
(Illustrations are Representative)*



Crimper (Refer
to Table)



Anvil (Refer
to Table)



AMP 3K/40 Terminating
Machines 2119683-[] or
AMP 5K/40 Terminating Machines
2119684-[] (409-10099)

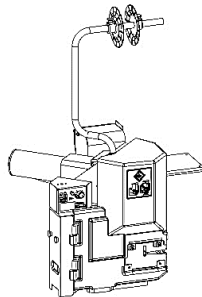

AMP 3K Terminating
Machines 1725950-[] or
AMP 5K Terminating Machines
1725900-[] (409-10047)

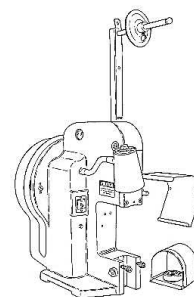

Basic AMP-O-LECTRIC
Model "K" Terminating
Machines 471273-[]
(409-5128)

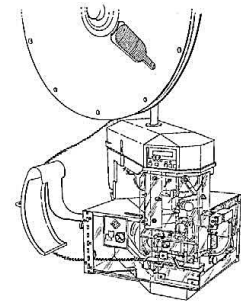

AMP-O-LECTRIC Model "G"
Terminating Machines
354500-[] (409-5842)

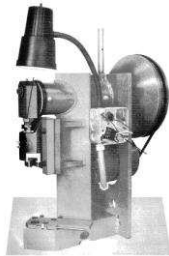

Model "T" Terminating Units 694620-[]
(409-5207) or 458000-4 (409-5289)

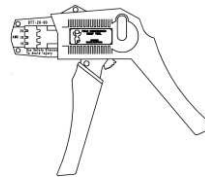

Hand Crimping Tool
DTT-20-00
(0425-072-0000)

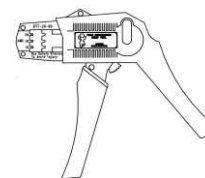

Hand Crimping Tool
DTT-20-02
(0425-073-0000)

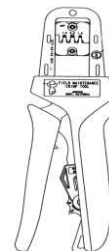

Hand Crimping Tool
DTT-20-03
(0425-076-0000)

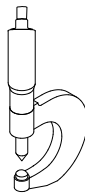

Crimp Height Micrometer
675836 (408-7424)



Crimp Height Micrometer
(With Peak) 547203-1 (408-7424)



Extraction Tools
(408-151007)

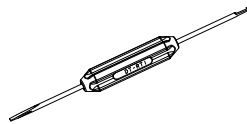

Removal Tool DT-RT1 for
Front-Release Connectors
(408-151008)

Contact 1060 (Pin); 1062 (Socket)	DEUTSCH Hand Crimping Tool
1060-20-01 1062-20-01 1062-20-03	DTT-20-00
1060-20-02 1062-20-02	DTT-20-02
1060-20-06 1062-20-06	DTT-20-03

Figure 5 (Cont'd)

Contact 1060 (Pin); 1062 (Socket)	Wire Size mm ² [AWG]	OCEAN Applicator	Insulation (Outside Diameter) Range	Wire Crimper	Insulation Crimper	Anvil
1060-20-01 1062-20-01 1062-20-03	0.35-1.50 [16-22]	2266116	2.74-3.18 [.108-.125]	1803364-2	1803019-4	1-1803293-2
		2266117	2.31-2.72 [.091-.107]		1803019-5	1-1803293-3
		2266118	1.90-2.29 [.075-.090]		1803019-6	1-1803293-4
1060-20-06 1062-20-06	1.00-2.50 [14-16]	2266121	2.74-3.18 [.108-.125]	4-1333281-8	1803019-4	1-1803293-7
		2266122	2.31-2.72 [.091-.107]		1803019-5	1-1803293-8
		2266123	1.90-2.29 [.075-.090]		1803019-6	1-1803293-9
1060-20-02 1062-20-02	0.35-1.50 [16-22]	2266119	1.60-2.16 [.063-.085]	1803364-2	1803019-7	1-1803293-5
		2266120	1.27-1.57 [.050-.062]		6-1803019-3	1-1803293-6

Contact 1060 (Pin); 1062 (Socket)	Wire Size mm ² [AWG]	DEUTSCH Applicator	Wire Punch Wire Anvil	Insulation (Outside Diameter) Range	Insulation Crimper	Insulation Anvil
1060-20-01 1062-20-01 1060-20-03	0.35-1.5 [22-16]	DCT20-02-00	1017-004-0200 1017-104-0200	2.74-3.18 [.108-.125]	1017-211-0200	1017-311-0200
				2.31-2.72 [.091-.107]	1017-213-0200	1017-313-0200
				1.91-2.28 [.075-.090]	1017-214-0200	1017-304-0200
1060-20-02 1062-20-02	0.35-1.5 [22-16]	DCT20-02-00	1017-004-0200 1017-104-0200	1.60-2.16 [.063-.085]	1017-217-0200	1017-317-0200
				1.27-1.57 [.050-.062]	1017-218-0200	1017-318-0200
1060-20-06 1062-20-06	0.35-1.5 [22-16]	DCT20-02-00	1017-761-0200 1017-762-0200	2.74-3.18 [.108-.125]	1017-211-0200	1017-311-0200
				2.31-2.72 [.091-.107]	1017-213-0200	1017-313-0200
				1.91-2.28 [.075-.090]	1017-214-0200	1017-304-0200
1060-20-01 1062-20-01 1060-20-03	0.35-1.5 [22-16]	DCT1620-02-00	1071-081-0200 1017-181-0200	2.68-3.02 [.105-.119]	1017-226-0200	1017-326-0200
				2.26-2.64 [.089-.104]	1017-227-0200	1017-327-0200
				1.93-2.23 [.076-.088]	1017-228-0200	1017-328-0200
1060-20-02 1062-20-02	0.35-1.5 [22-16]	DCT1620-02-00	1071-081-0200 1017-181-0200	1.67-2.38 [.066-.094]	1017-229-0200	1017-329-0200
				1.27-1.57 [.050-.062]	1017-230-0200	1017-330-0200
1060-20-06 1062-20-06	1.00-2.50 [16-14]	DCT1620-02-00	1071-758-0200 1071-759-0200	2.68-3.02 [.105-.119]	1017-226-0200	1017-326-0200
				2.26-2.64 [.089-.104]	1017-227-0200	1017-327-0200
				1.93-2.23 [.076-.088]	1017-228-0200	1017-328-0200

Figure 5 (End)

6. VISUAL AID

The illustration below shows a typical application of DEUTSCH size 20 S&F pin and socket contacts. This illustration should be used by production personnel to ensure a correctly applied product. Applications which DO NOT appear correct should be inspected using the information in the preceding pages of this specification and in the instructional material shipped with the product or tooling. Figure 3. Visual aid

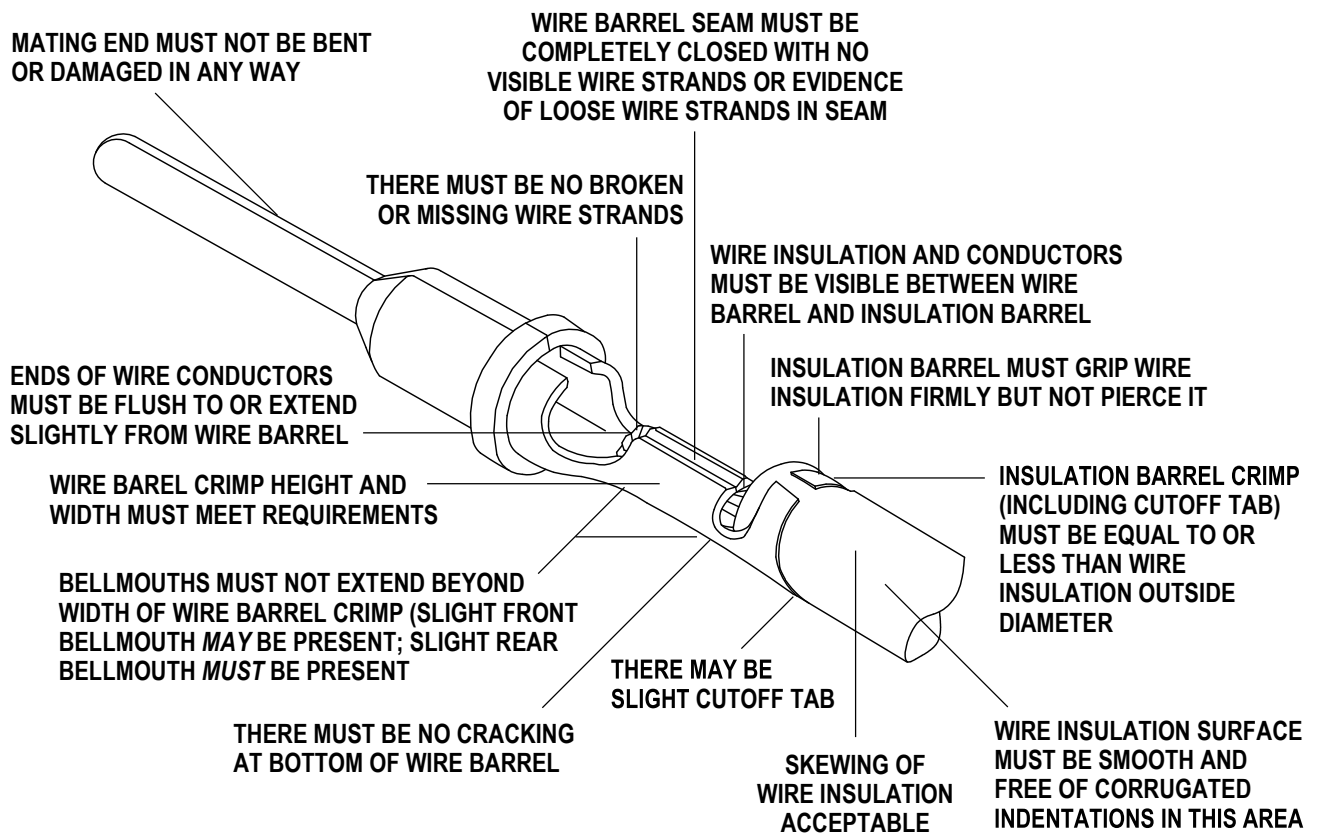

FIGURE 6. VISUAL AID



7. REVISION HISTORY

Rev Ltr	Brief Description of Change	Date	Dwn	Apvd
A	Initial Release	27-Feb-17	PV	DM
B	Page 10. a) 2266118/23 OCEAN applicator max insulation range (is) 2.29 (was) 2.28. b) Updated 2266116/17/18/19/20 wire crimper (is) 1803364-2 (was) 4-1633713-4	24-Jan-18	SS	DM