

Terminal Block Plug

20.920M/xx-E (21.920M/xx-E)

- 300V 15A UL
- UL94-V0
- PA66
- 5.00mm (5.08mm) Pin Pitch
- RoHS Compliant
- xx = Number of Poles (available from 2~24 poles)



Technical Data

Pitch	5.00mm (5.08mm)
UL Rating	300V 15Amps
IEC Rating	450V 20Amps
Solder Pin	n/a
Wire Range	28-14AWG (2.5mm ²)
PCB Hole Diameter	n/a
Screw	M3.0 Steel (Zinc Plate)
Screw Torque	0.5Nm
Insulation Voltage	AC2000V / 1 Min
Initial Contact Resistance	20mΩ
Insulation Resistance	500MΩ / DC500V
Temperature Range	-40 to +105°C
Max Soldering	+250°C for 5 sec

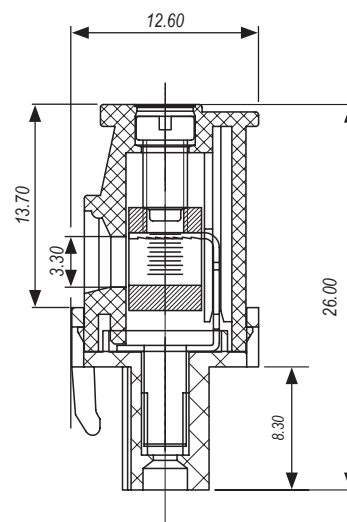
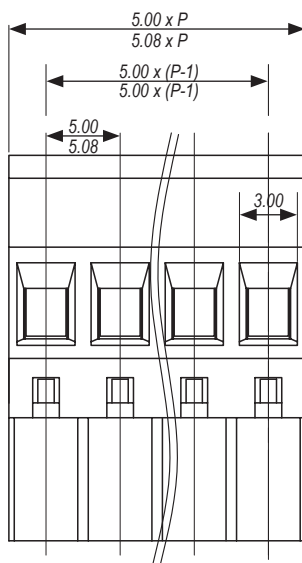

Dimensions shown in mm P = No of Poles

Supplied in green as standard
 Other colour options and printing may be available depending upon quantity
 Please contact IMO for further information