

433 MHz Ceramic Chip Antenna



ACAG1204-433-T

12.0 x 4.0 x 1.6mm



RoHS/RoHS II Compliant

MSL = 3

FEATURES

- Made using LTCC (low temperature co-fired ceramic) technology
- Low frequency of 433 MHz
- $VSWR \leq 2$
- Compact profile 12.0 x 4.0 x 1.6mm
- Omni-directional

APPLICATIONS

- ISM Band
- RFID
- SigFox
- LoRa
- Wireless
- Home Automation
- IoT
- Medical Devices
- Smart Meters
- Remote Technology/Monitoring
- M2M

ELECTRICAL CHARACTERISTICS

Item	Spec
Frequency	433 MHz
Bandwidth	10 MHz typ
Return Loss	-6.5 dB
VSWR	≤ 2.0
Impedance	50 Ω
Peak Gain	-1.72 dBi
Azimuth	Omni-directional
Polarization	Linear
Operating Temperature Range	-40 $^{\circ}$ C ~+ 85 $^{\circ}$ C

MECHANICAL DIMENSIONS

Antenna Dimensions

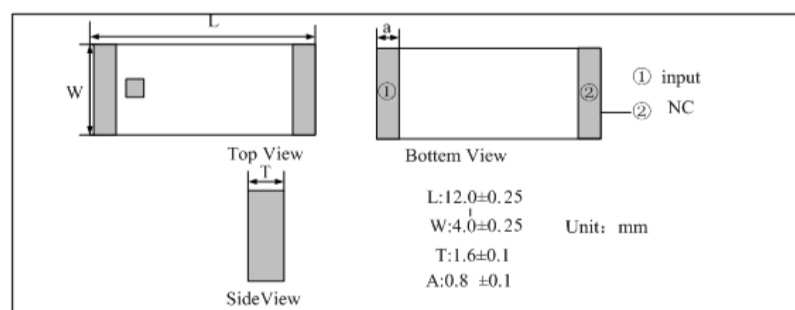

Layout Dimensions

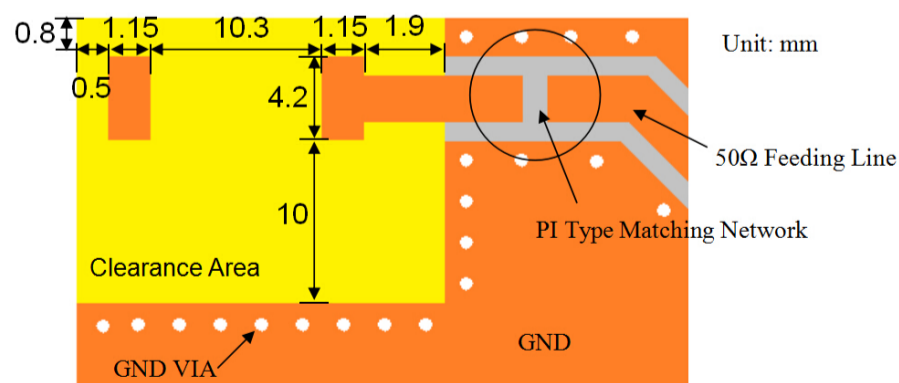

Dimensions (mm)

433 MHz Ceramic Chip Antenna

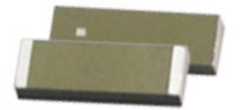

ACAG1204-433-T

12.0 x 4.0 x 1.6mm



RoHS/RoHS II Compliant

MSL = 3

EVALUATION BOARD AND MATCHING CIRCUITS

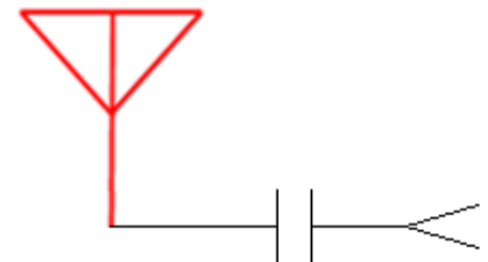
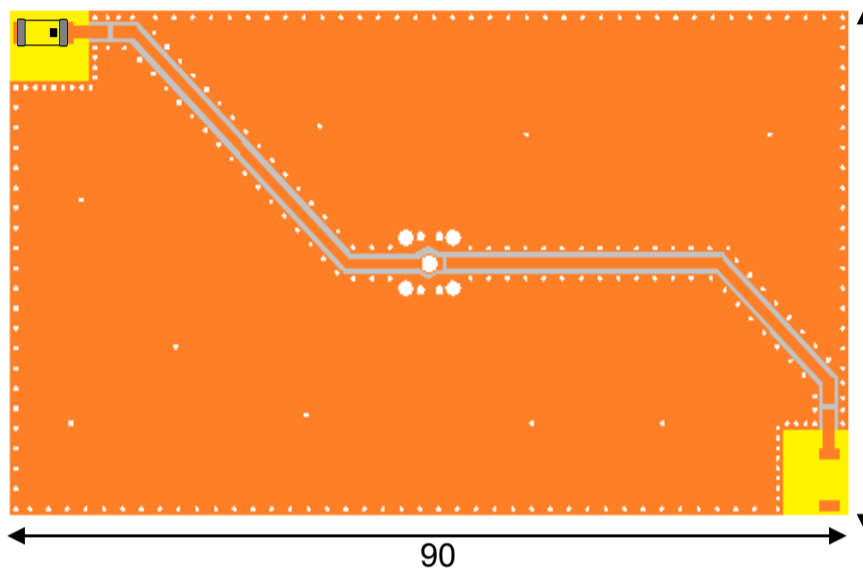

ANTENNA RESPONSE – SMITH CHART AND RETURN LOSS S11

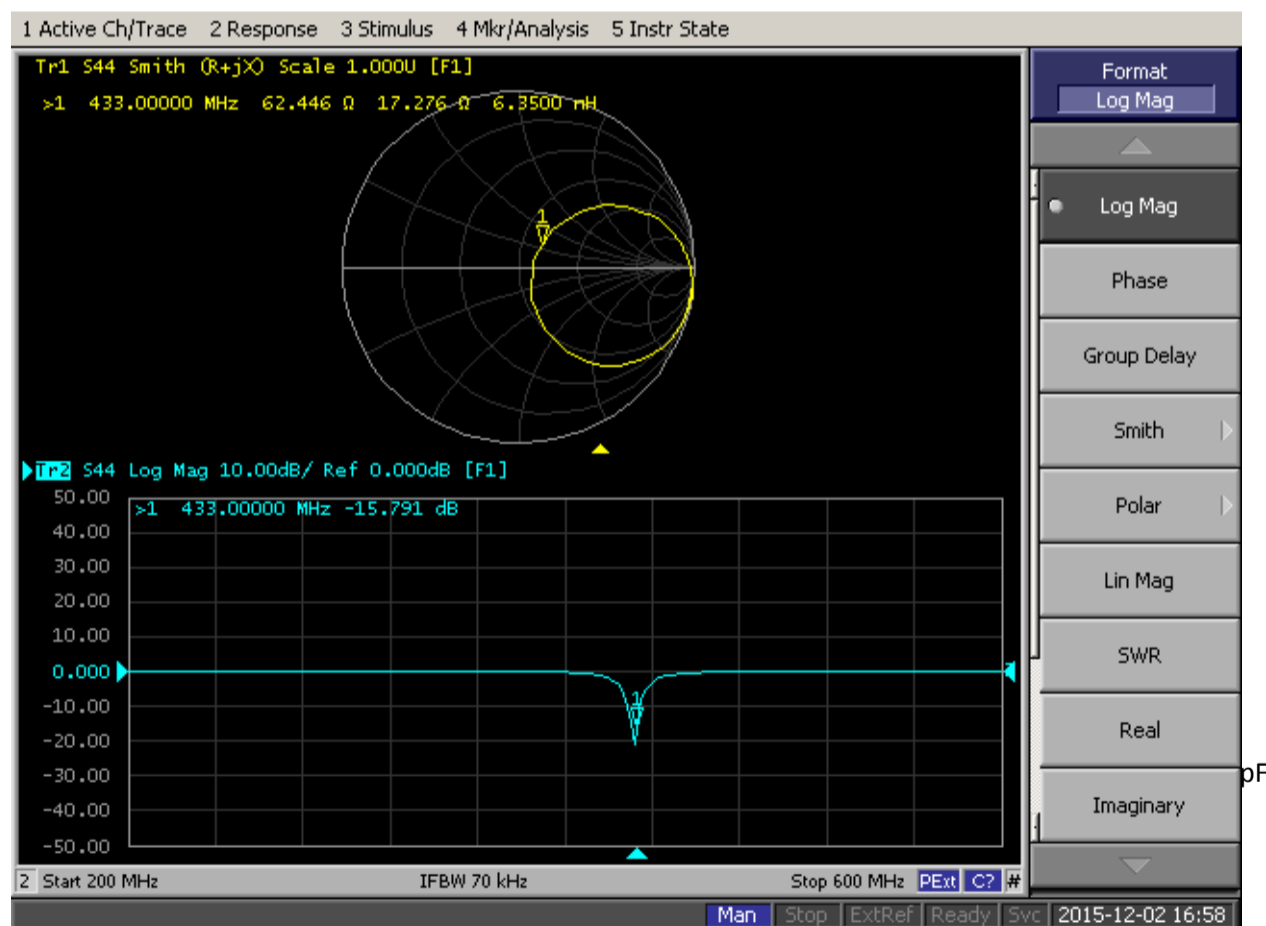

433 MHz Ceramic Chip Antenna

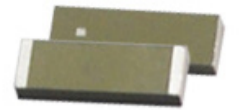

ACAG1204-433-T

12.0 x 4.0 x 1.6mm



RoHS/RoHS II Compliant

MSL = 3

RADIATION PATTERNS

Coordinates

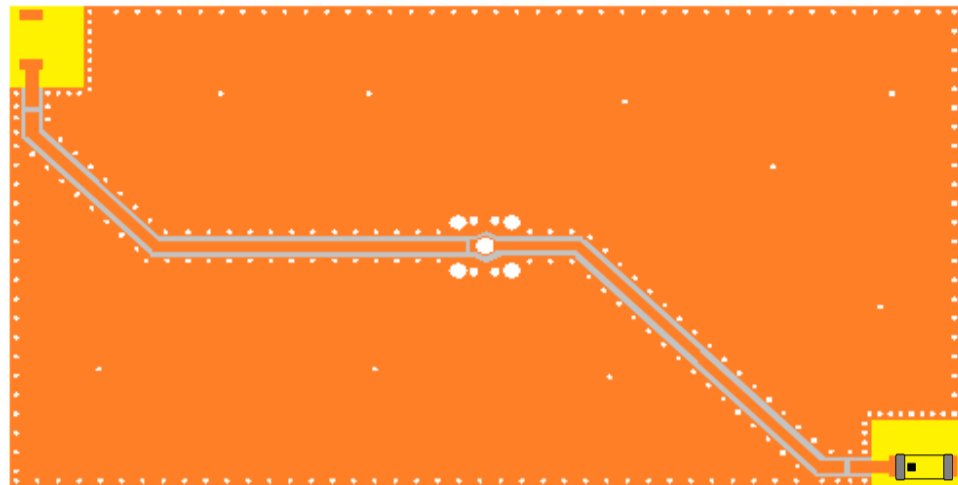
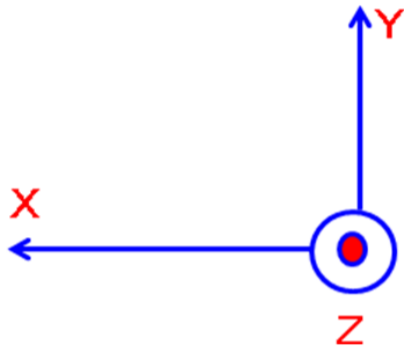

RADIATION PATTERNS

X-Z Plane

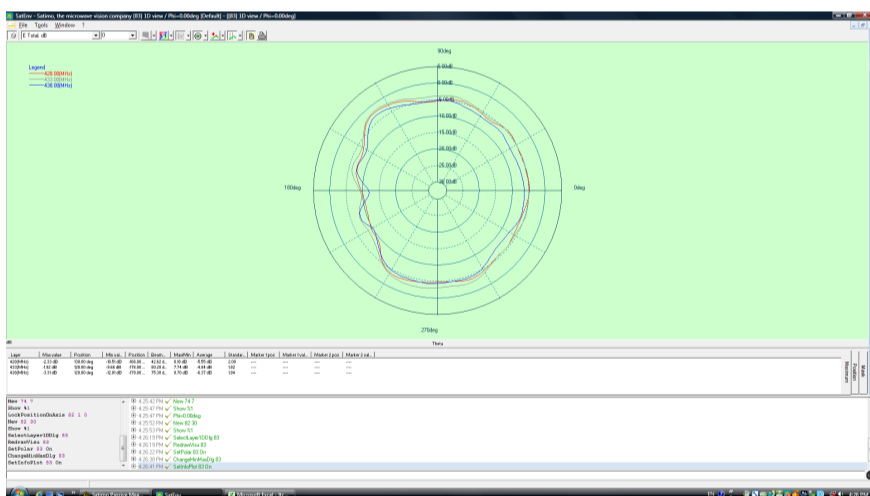

Y-Z Plane

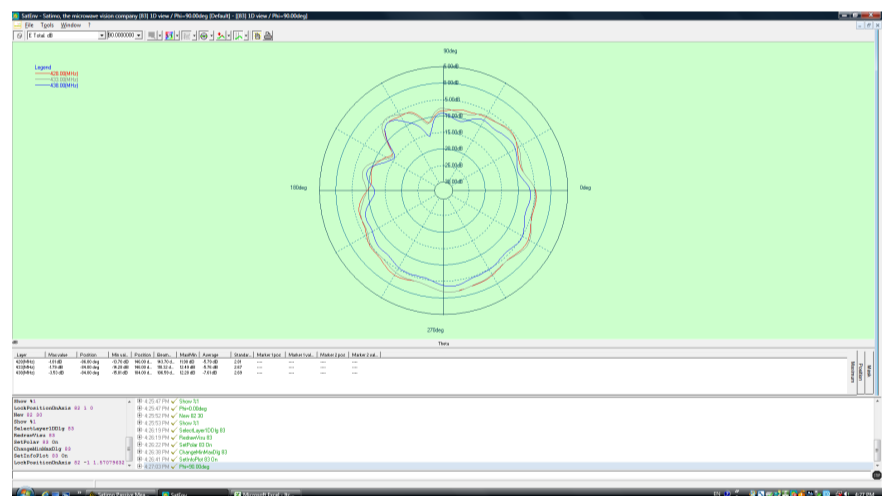

X-Y Plane

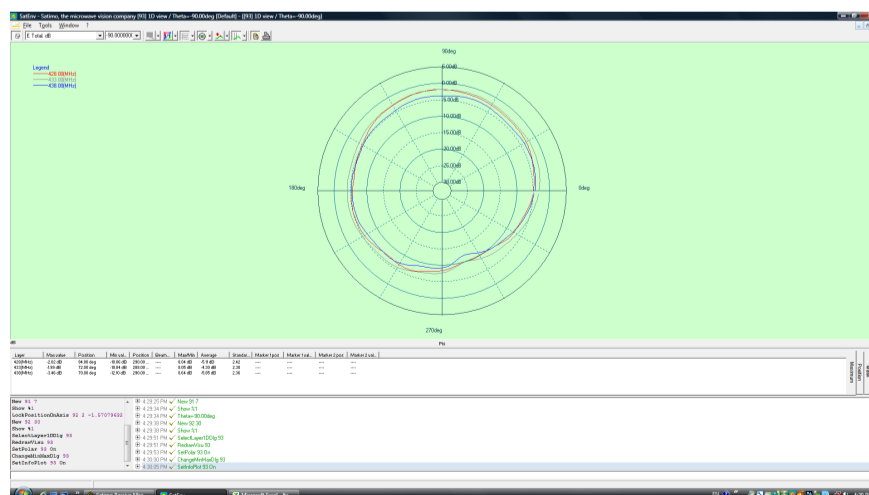

REVISED: 03.19.2018



5101 Hidden Creek Ln Spicewood TX 78669
Phone: 512-371-6159 | Fax: 512-351-8858
For terms and conditions of sales, please visit:
www.abracon.com

ABRACON IS
ISO9001-2008
CERTIFIED

433 MHz Ceramic Chip Antenna



ACAG1204-433-T

12.0 x 4.0 x 1.6mm

 RoHS/RoHS II Compliant

MSL = 3

3D PATTERNS

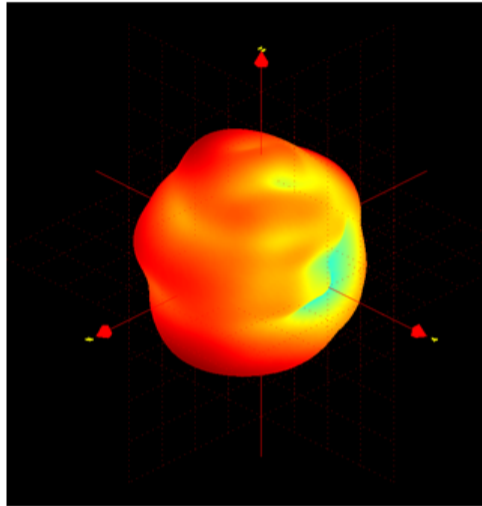

Frequency (MHz)	428	433	438
Avg. Gain (dBi)	-5.55	-4.84	-6.37
Peak Gain (dBi)	-1.85	-1.72	-1.93
Efficiency (%)	33	35	33

REFLOW SOLDERING STANDARD CONDITION

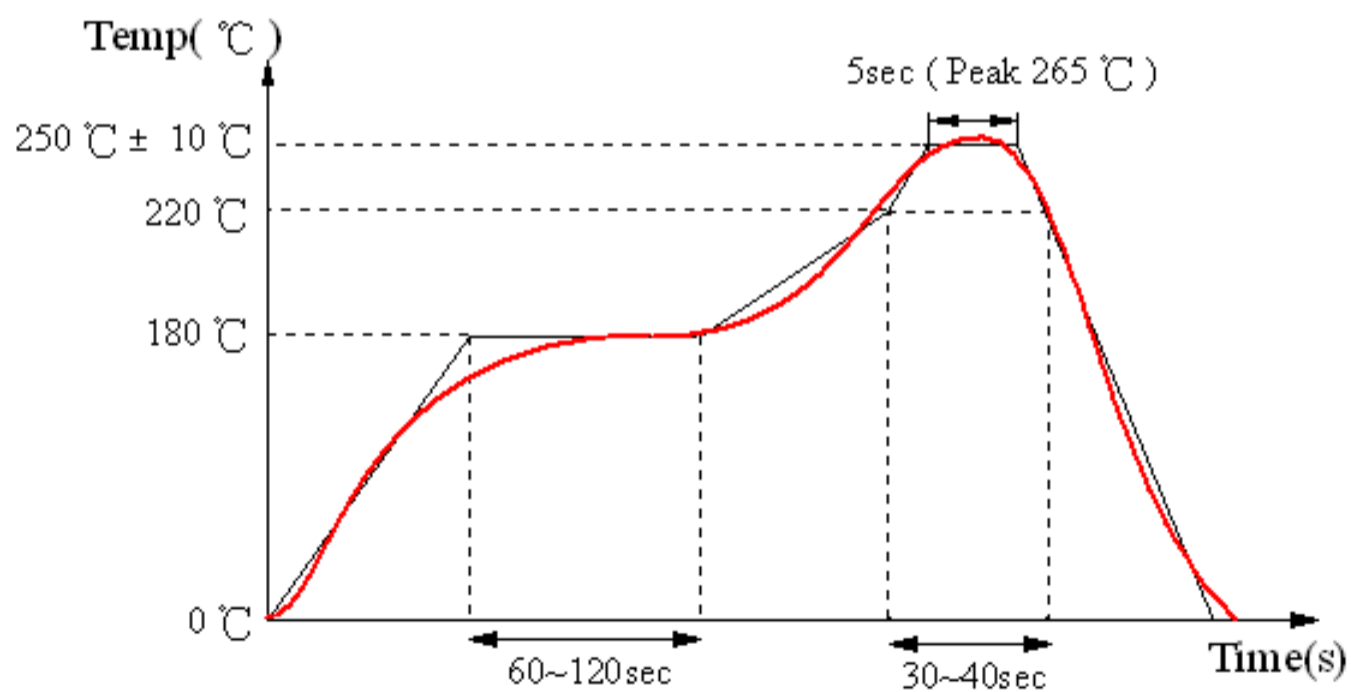

433 MHz Ceramic Chip Antenna

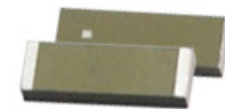

ACAG1204-433-T

12.0 x 4.0 x 1.6mm



RoHS/RoHS II Compliant

MSL = 3

PACKAGING

Package Type	Quantity/Size
Inner Box	3000 pcs/reel
Size of the carton	345 x 250 x 360 mm

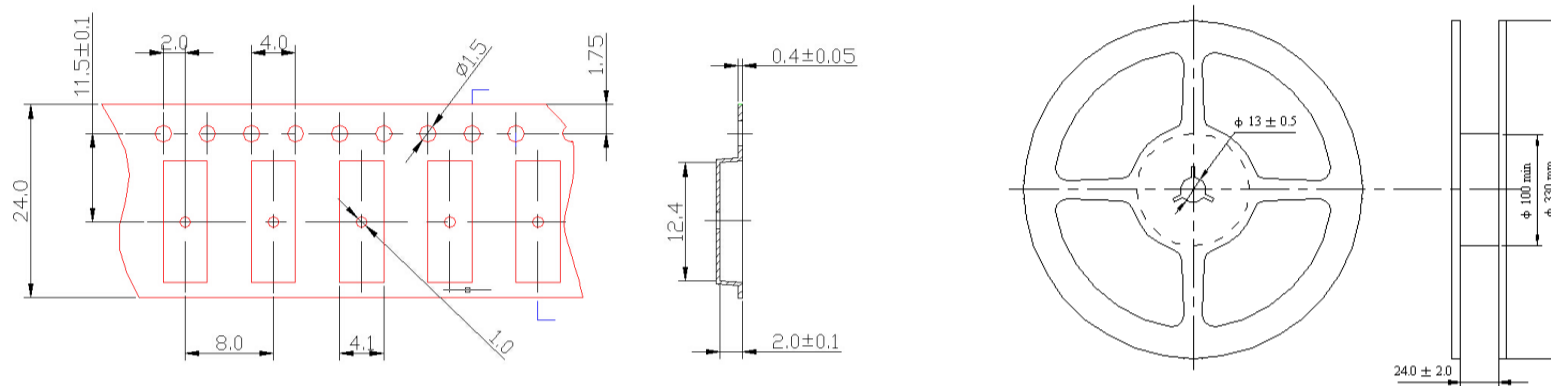

Storage Temperature Range : <30 degree C, Humidity : <60%RH

MSL - 3

Oxidizable, 12 months in a vacuum sealed bag.

Once opened, please repack the unused items within 168 hours by re-seal package treatment.

Dimensions: mm

CAUTIONS

1. Static voltage

Static voltage between signal & ground may cause deterioration & destruction of the component. Please avoid static voltage.

2. Ultrasonic cleaning

Ultrasonic vibration may cause deterioration & destruction of the component. Please avoid ultrasonic cleaning.

3. Soldering

Only leads of the component may be soldered. Please avoid soldering to any other part of the component, such as on the patterns as this will change the performance of the antenna.