

Data sheet

Connection line M12 plug angled - RJ45 plug straight 4-pole, D-coded 5.0 m

Page 1/5

P/N

142M4D95050

EAN 4251394601007

2018-26-03

Illustrations



Dimensional drawing

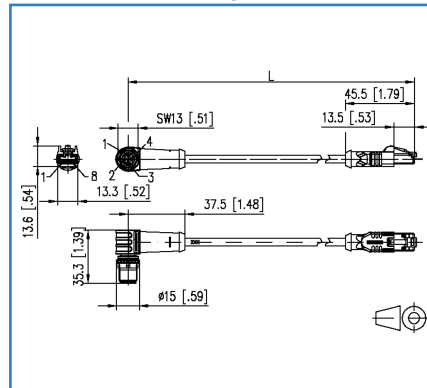

Wiring

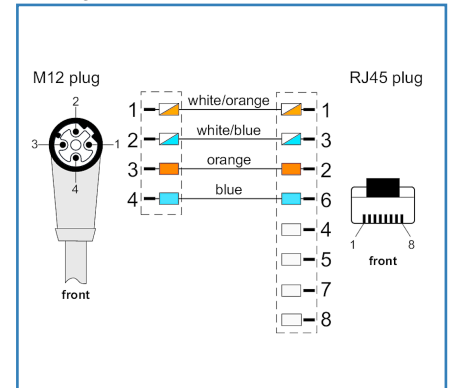

See enlarged drawings at the end of document

Product specification

- shielded M12 to RJ45 Ethernet connection line
- Cat.5e, 4-pole, D-coded (IEC 61076-2-101)
- side 1: M12 plug, angled
- side 2: RJ45 plug, straight
- extrusion-coated cable on connectors
- stranded wires 4x1xAWG26/19
- overall shield: tinned copper braid
- pin assignment per Profinet
- green cable, PUR
- variants: 1.0 m, 2.0 m, 5.0 m, 10.0 m
- other cable lengths on request



Data sheet

Page 2/5

Connection line M12 plug angled - RJ45 plug straight 4-pole, D-coded 5.0 m

P/N

142M4D95050

EAN 4251394601007

2018-26-03

Technical Data

General Data

Fields of application

Industrial Ethernet

Design

Ethernet-Connection line

Shielding

shielded

Transmission technology

Copper

Cable Type

S/UTP

Number of twisting elements

4

Twisting element

single core

Wiring

Profinet

Color coding fiber/ wire(s)

white/orange, white/blue, orange, blue

Color

green

Dimensions

Dimension - Interface 1 (L x W x H)

36.60 x 15.00 x 44.50 mm

Dimension - Interface 1 (L x W x H)

1.441 x 0.591 x 1.752 in.

Dimension - Interface 2 (L)

45.50 mm

Dimension - Interface 2 (L)

1.791 in.

Cable length (m)

5.00 m

Weight

31 kg/km

Labeling option

identification label carrier

Transmission characteristics

Category (ISO)

5e

Connections/interfaces

Connector technology interface 1

M12-plug

Connector technology interface 2

RJ45 plug

Coding interface 1

data systems technology tool

Number of positions/contacts interface 1

4

Number of positions/contacts interface 2

8P/4C

Termination data, stranded wire (min. - max.)

Conductor cross section, stranded wire

AWG 26/19



Data sheet

Page 3/5

Connection line M12 plug angled - RJ45 plug straight 4-pole, D-coded 5.0 m

P/N

142M4D95050

EAN 4251394601007

2018-26-03

Technical Data

Connections/interfaces

Cable sheath diameter (min. - max.)

Cable sheath diameter 4.80 mm

Cable sheath diameter 0.189 in.

Electrical characteristics

Current carrying capacity max. 4, max. 1 A

Insulation resistance min. 100 MOhm

Mechanical characteristics

Maximum operating bending radius 19 mm

Maximum operating bending radius 0.748 in.

Maximum installation load 36 mm

Maximum installation load 1.417 in.

Shielding braid coverage 85 %

Materials and material properties

Material - Conductor Cu (copper)

Material - Conductor Insulation polypropylene

Material - Cable jacket PUR

Material - Body interface 1 Plastics

Material - Body interface 2 Plastics

Material - Contact interface 1 CuSn (tin bronze)

Material - Contact interface 2 CuSn (tin bronze)

Material - Contact finish interface 1 Au (gold)

Material - Contact finish interface 2 Au (gold)

Material - Contact carriers interface 1 Plastics

Material - Contact carriers interface 2 Plastics

Material - Union nut interface 1 CuZn (brass)

Material - Union nut finish interface 1 Ni (nickel)

Material - Main shield Cu (copper) braid

Material - Main shield finish Sn (tin)

Flame retardancy yes

Halogen free yes

Silicone free yes

Oil resistance yes



Data sheet

Page 4/5

Connection line M12 plug angled - RJ45 plug straight 4-pole, D-coded 5.0 m

P/N

142M4D95050

EAN 4251394601007

2018-26-03

Technical Data

Materials and material properties

UV-resistance yes

Environmental conditions

Temperature (min. - max.)

Temperature - Operating °C -30 - 70 °C

Temperature - Operating °F -22 - 158 °F

Particulate ingress interface 1 IP6X when plugged in

Liquid ingress/immersion interface 1 IPX5, IPX7, IPX8 when plugged in

Particulate ingress interface 2 IP2X when plugged in

Liquid ingress/immersion interface 2 IPX0 when plugged in

Pollution degree interface 1 3

Pollution degree interface 2 1

Approvals

RoHS compliant

The product meets the following standards

Profinet yes

Connectors for electronic equipment

circular connector DIN EN 61076-2-101

Test for vertical flame propagation for a single insulated wire or cable DIN EN 60332-1-2

Packing details

Type of packaging 1 pc(s) / plastic bag



Data sheet

Page 5/5

Connection line M12 plug angled - RJ45 plug straight
4-pole, D-coded 5.0 m

P/N

142M4D95050

EAN 4251394601007

2018-26-03

Illustrations

Dimensional drawing

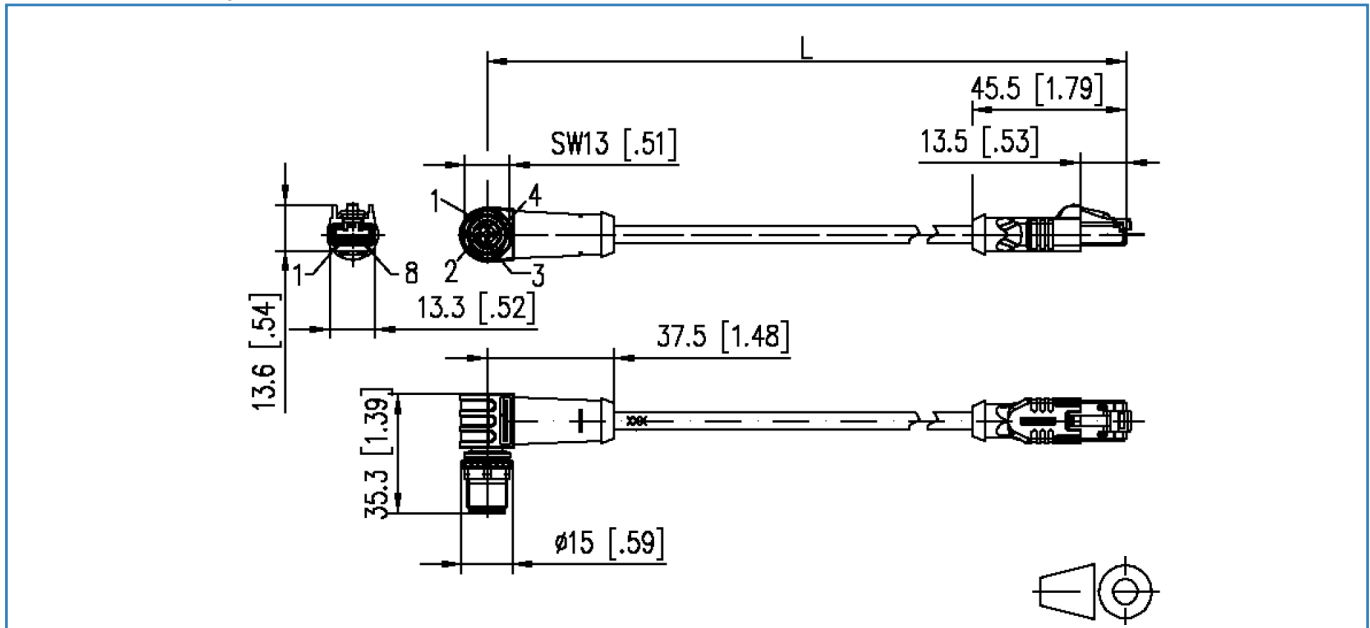

Wiring

