

Data sheet

Connection cable M12 X-coded, 5.0 m
M12 plug angled - free line end
8-pole, position of coding 45°

Page 1/5

P/N
142M2XA0050
EAN 4251394608808

2018-26-03

Illustrations



Dimensional drawing

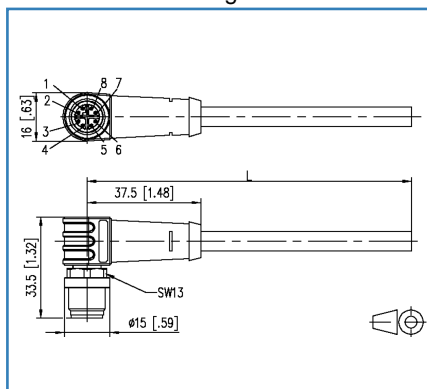

Anschlussbild 142M2XA0xxx

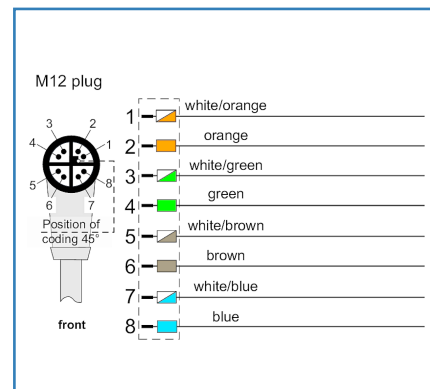

See enlarged drawings at the end of document

Product specification

- shielded M12 Ethernet connection cable
- Cat.6_A, x-coded, 8-pole
- side 1: M12 connector, angled, position of coding 45°
- side 2: free line end
- M12 connector over molded
- stranded wires 4x2xAWG26/7
- overall shield tinned copper braid
- green cable, PUR
- standard variants: 1.0 m, 2.0 m, 5.0 m, 10.0 m
- other cable lengths on request

Data sheet

Page 2/5

Connection cable M12 X-coded, 5.0 m M12 plug angled - free line end 8-pole, position of coding 45°

P/N

142M2XA0050

EAN 4251394608808

2018-26-03

Technical Data

General Data

Fields of application	Industrial Ethernet
Design	Ethernet-Connection cable
Shielding	shielded
Transmission technology	Copper
Cable Type	S/FTP
Number of twisting elements	4
Twisting element	Pair
Color coding fiber/ wire(s)	white/orange, orange, white/green, green, white/brown, brown, white/blue, blue
Color	green
Dimensions	
Dimension - Interface 1 (L x W x H)	33.50 x 15.00 x 44.50 mm
Dimension - Interface 1 (L x W x H)	1.319 x 0.591 x 1.752 in.
Cable length (m)	5.00 m
Labeling option	identification label carrier

Transmission characteristics

Category (ISO)	6 _A
----------------	----------------

Connections/interfaces

Connector technology interface 1	M12-plug
Coding interface 1	X-coded
Number of positions/contacts interface 1	8
Termination data, stranded wire (min. - max.)	
Conductor cross section, stranded wire	AWG 26/7
Conductor cross section, stranded wire	0.141 mm ²
Conductor diameter, stranded wire (bare copper)	0.483 mm
Conductor diameter, stranded wire (bare copper)	0.019 in.
Cable sheath diameter (min. - max.)	
Cable sheath diameter	6.40 mm
Cable sheath diameter	0.236 in.

Data sheet

Page 3/5

Connection cable M12 X-coded, 5.0 m M12 plug angled - free line end 8-pole, position of coding 45°

P/N

142M2XA0050

EAN 4251394608808

2018-26-03

Technical Data

Electrical characteristics

Current carrying capacity	0.5 A
Insulation resistance	min. 100 MOhm

Mechanical characteristics

Maximum operating bending radius	64 mm
Maximum operating bending radius	2.52 in.
Maximum installation load	32 mm
Maximum installation load	1.26 in.
Shielding braid coverage	70 %

Materials and material properties

Material - Conductor	Cu (copper)
Material - Conductor Insulation	Polyethylen
Material - Cable jacket	PUR
Material - Body interface 1	Plastics
Material - Contact interface 1	CuZn (brass)
Material - Contact finish interface 1	Au (gold)
Material - Contact carriers interface 1	Plastics
Material - Union nut interface 1	CuZn (brass)
Material - Union nut finish interface 1	Ni (nickel)
Material - Pair shield	plastic film
Material - Pair shield finish	Al (Aluminium)
Material - Main shield	Cu (copper) braid
Material - Main shield finish	Sn (tin)
Flame retardancy	yes
Halogen free	yes
Oil resistance	yes
UV-resistance	yes

Environmental conditions

Temperature (min. - max.)	
Temperature - Operating °C	-30 - 90 °C
Temperature - Operating °F	-22 - 194 °F
Particulate ingress interface 1	IP6X when plugged in
Liquid ingress/immersion interface 1	IPX5, IPX7 when plugged in



Data sheet

Page 4/5

Connection cable M12 X-coded, 5.0 m M12 plug angled - free line end 8-pole, position of coding 45°

P/N
142M2XA0050
EAN 4251394608808

2018-26-03

Technical Data

Environmental conditions

Pollution degree interface 1 3

Approvals

RoHS compliant

The product meets the following standards

Connectors for electronic equipment

Free and fixed connectors IEC 60603-7-51

circular connector DIN EN 61076-2-109

Multi-element metallic cables used in analogue and digital communication and control DIN EN 50288-4-2

Test for vertical flame propagation for a single insulated wire or cable DIN EN 60332-1-2

Measurement of smoke density of cables burning IEC 61034

Classifications

ETIM 5.0 EC002599

ETIM 6.0 EC002599

Packing details

Type of packaging 1 pc(s) / plastic bag



Data sheet

Page 5/5

Connection cable M12 X-coded, 5.0 m M12 plug angled - free line end 8-pole, position of coding 45°

P/N
142M2XA0050
EAN 4251394608808

2018-26-03

Illustrations

Dimensional drawing

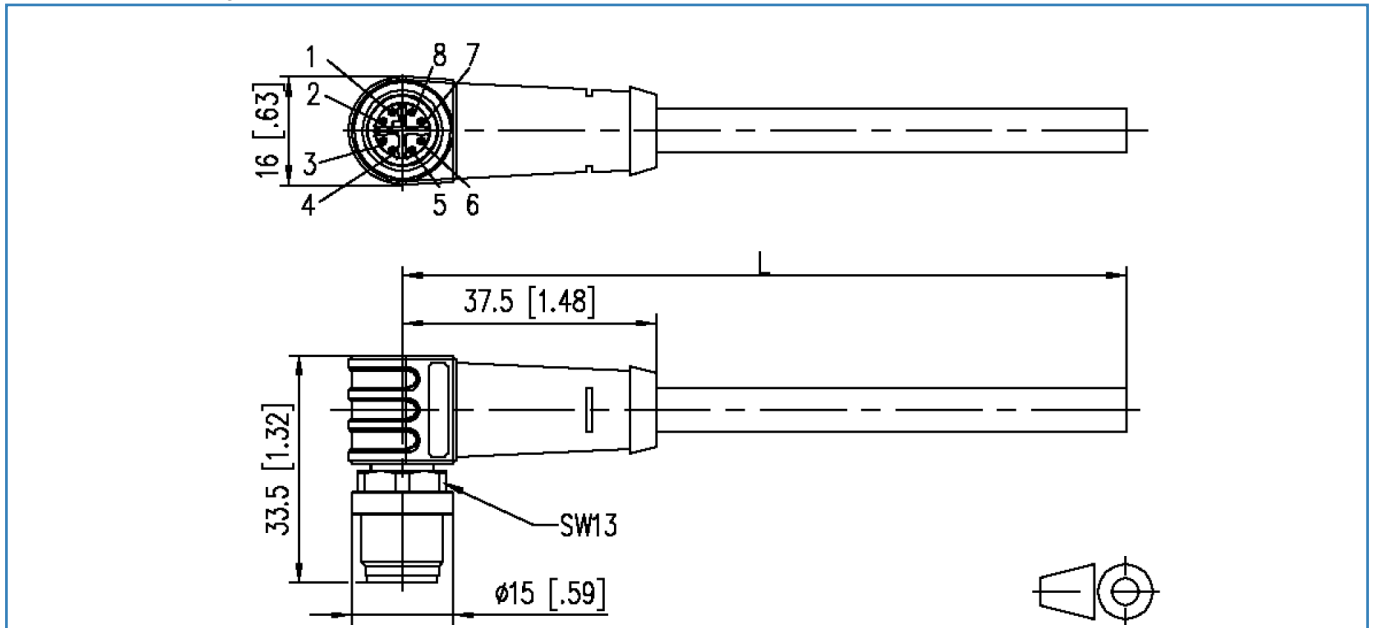

Anschlussbild 142M2XA0xxx

