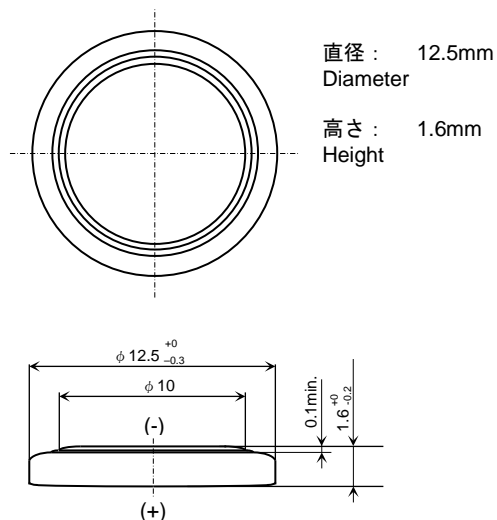

コイン形二酸化マンガンリチウム電池
 Coin manganese dioxide lithium batteries

CR1216

■外形寸法 Dimensions(mm)

■定格 Specifications

| | |
|--|-------|
| 公称電圧 Nominal Voltage | 3V |
| 公称容量 (終止電圧 2.0V) Nominal Capacity (2.0V cutoff) | 30mAh |
| 標準放電電流値 Standard Discharge Current | 0.1mA |
| 標準質量 Weight | 0.7g |

用途 Applications

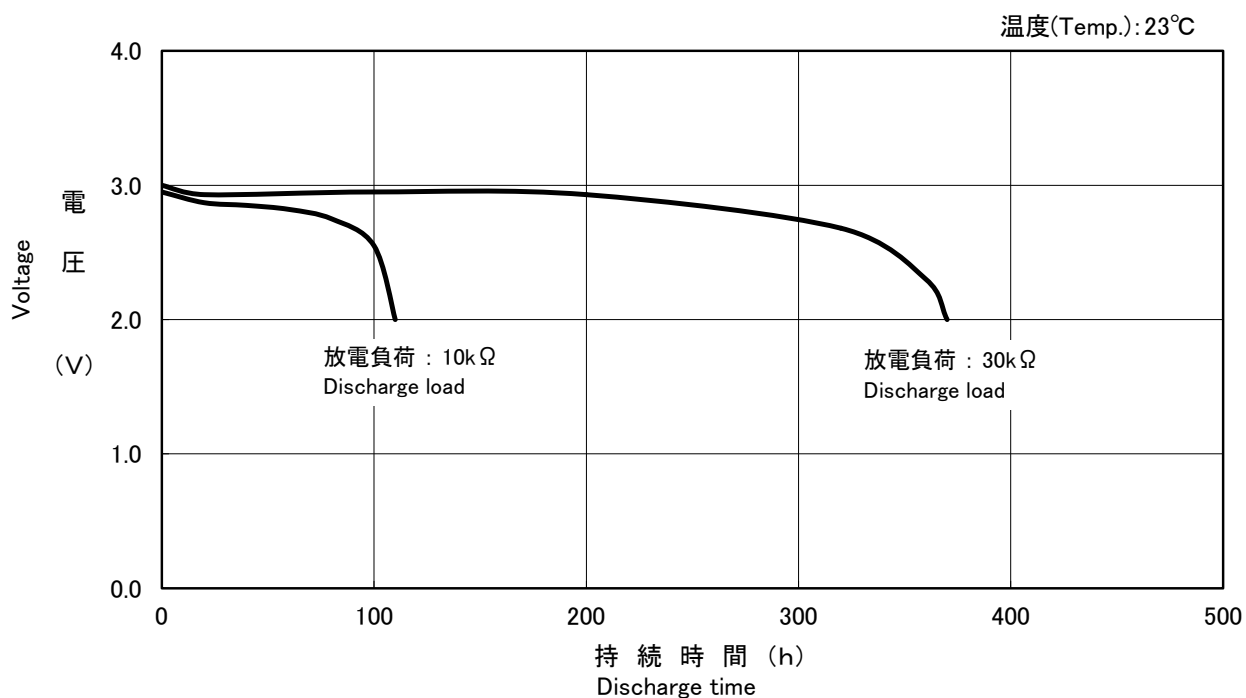
- 時計
- 電子手帳・電卓
- SRAMやリアルタイムクロック等メモリーバックアップ
- Electronic Watch or Clock
- Electronic Calculator
- Memory Back-up Power Source for SRAM or Real Time Clock (RTC)

■放電特性 Discharge Characteristics

■放電負荷特性

Discharge Characteristics on Load

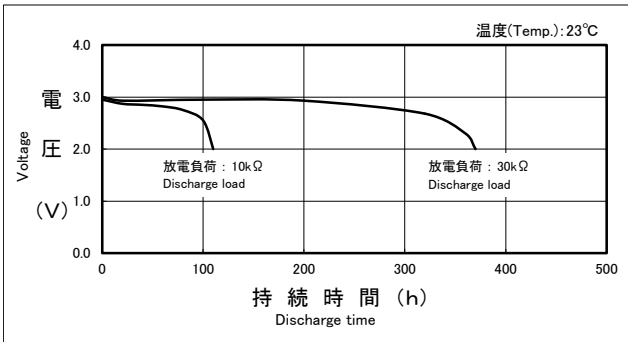

■放電温度特性

Discharge Characteristics on Temperature

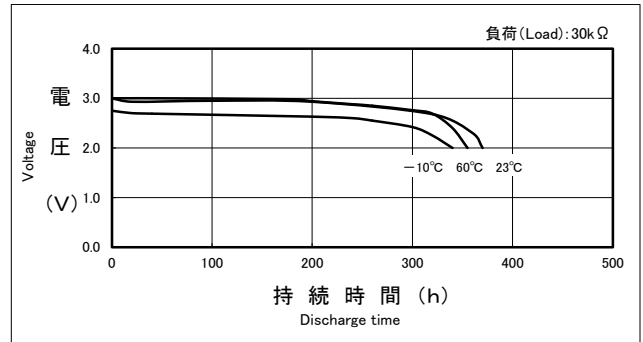

■放電負荷と作動電圧 (放電深度 40%時の電圧)

Discharge Load vs. Operation Voltage (Discharge depth 40%)

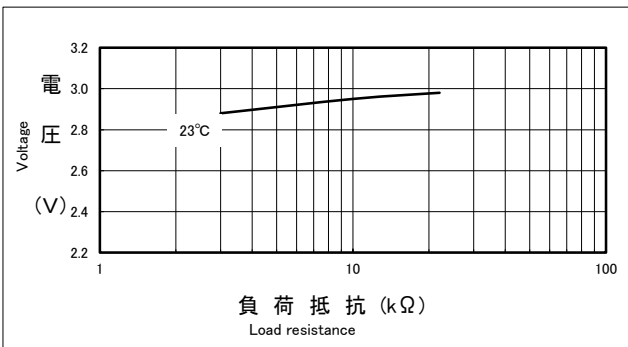

■放電負荷と電気容量

Discharge Load vs. Discharge Capacity

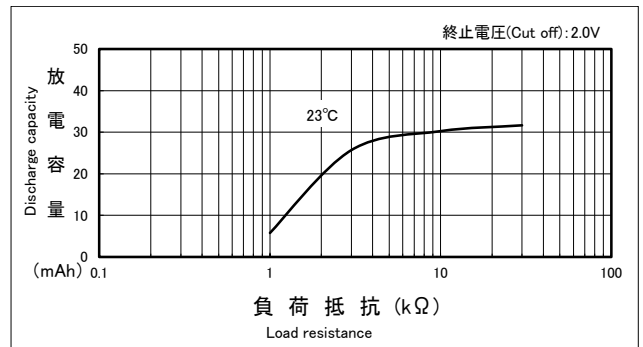

■パルス放電特性 (放電深度 40%時のパルス電圧)

Discharge Characteristics on Pulse Load (Discharge depth 40%)

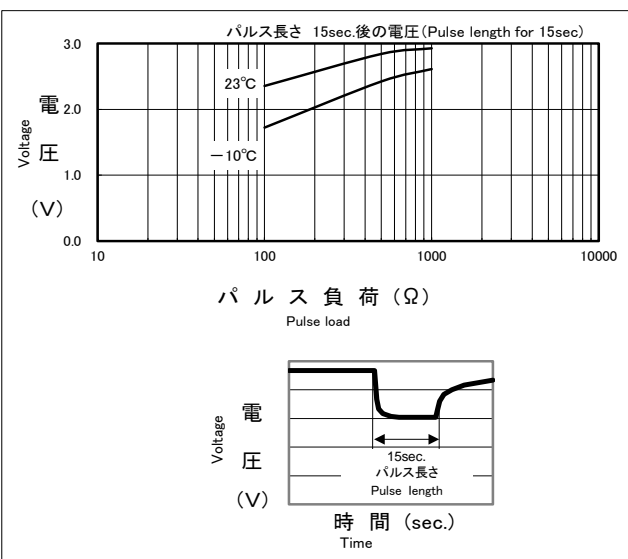

■保存特性

Storage Characteristics

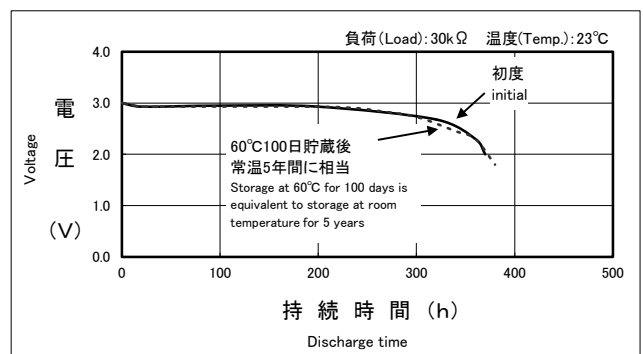

*記載のデータ及び数値は、参考値であり保証値ではありません。

*Data is not guaranteed, and is provided for reference purposes only.