

IEC Appliance Outlet F or H, Screw-on Mounting, Front Side, Solder or Quick-connect Terminal

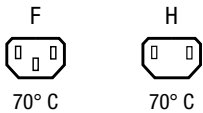

See below:

**Approvals and Compliances**

**Description**

- Panel Mount :  
Screw-on mounting , from front side
- 1 Function :
- Connector , Pin temperature 70 °C , protection class I or II
- Solder terminals or quick connect terminals

**References**

We recommend for new applications the type [6600-3](#)

**Weblinks**

[pdf datasheet](#), [html-datasheet](#), [General Product Information](#), [Distributor-Stock-Check](#), [Accessories](#), [Detailed request for product](#)

**Technical Data**

Ratings IEC	10A / 250VAC; 50Hz
Ratings UL/CSA	15A / 250VAC; 60Hz
Dielectric Strength	> 4 kVAC between L-N > 2 kVAC between L/N-PE (1 min/50Hz)
Allowable Operation Temperature	-25 °C to 70 °C
IP-Protection	from front side IP 20 acc. to IEC 60529
Insulation cover	Suitable for appliances with protection class I or II acc. to IEC 61140
Terminal	Solder terminals or quick connect terminals
Material: Housing	PA6, black or grey, UL 94V-0

appliance inlet/-outlet	F acc. to IEC 60320-3 / H UL 498, CSA C22.2 no. 42 (for cold conditions) pin-temperature 70 °C, 10A, Protection Class I or II
-------------------------	--

**Approvals and Compliances**

Detailed information on product approvals, code requirements, usage instructions and detailed test conditions can be looked up in [Details about Approvals](#)

**Approvals**





The approval mark is used by the testing authorities to certify compliance with the safety requirements placed on electronic products.

Approval Reference Type: 5098

Approval Logo	Certificates	Certification Body	Description
	<a href="#">VDE Approvals</a>	VDE	VDE Certificate Number: 40010295
	<a href="#">UL Approvals</a>	UL	UL File Number: E57445
	<a href="#">CSA Approvals</a>	CSA	CSA Certification Record: 27324

**Product standards**

Product standards that are referenced

Organization	Design	Standard	Description
	Designed according to	IEC 60320-1	Appliance couplers for household and similar general purposes
	Designed according to	IEC 60320-3	Appliance couplers for household and similar general purposes
	Designed according to	UL 498	Standard for Attachment Plugs and Receptacles
	Designed according to	CSA C22.2 no. 42	General Use Receptacles, Attachment Plugs, and Similar Wiring Devices





**Application standards**

Application standards where the product can be used

Organization	Design	Standard	Description
	Designed for applications acc.	IEC/UL 60950	IEC 60950-1 includes the basic requirements for the safety of information technology equipment.

**Compliances**

The product complies with following Guide Lines

Identification	Details	Initiator	Description
	<a href="#">CE declaration of conformity</a>	SCHURTER AG	The CE marking declares that the product complies with the applicable requirements laid down in the harmonisation of Community legislation on its affixing in accordance with EU Regulation 765/2008.
	RoHS	SCHURTER AG	EU Directive RoHS 2011/65/EU
	China RoHS	SCHURTER AG	The law SJ / T 11363-2006 (China RoHS) has been in force since 1 March 2007. It is similar to the EU directive RoHS.
	REACH	SCHURTER AG	On 1 June 2007, Regulation (EC) No 1907/2006 on the Registration, Evaluation, Authorization and Restriction of Chemicals 1 (abbreviated as "REACH") entered into force.

**Dimensions [mm]**

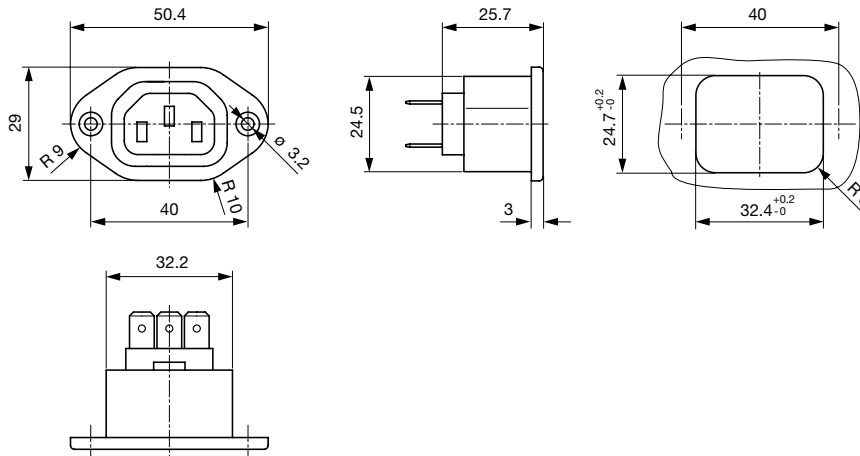

Length of the terminal please find at the order code configuration table

**Config. Code**

5098 - H - A B C 0 - D - E O

The characters are placeholders for the correspondingly keys of selections from the key tables.

5098 - **H** - A B C 0 - D - E O = Type

Type	Configuration key	Type	Configuration key
protection class I	B	protection class I	X
protection class II	B		

5098 - H - **A** B C 0 - D - E O = Terminals

Terminal L	Configuration key
solder terminal	1
Blade terminal (6.3 x 0.8 mm)	9

5098 - H - A **B** C 0- D - E O = Terminals

Terminal N	Configuration key
solder terminal	1
Blade terminal (6.3 x 0.8 mm)	9

Symbols similar as in table A

5098 - H - A B **C** 0- D - E O = Terminals

Terminal Ground	Configuration key
without terminal	0
solder terminal	1
Blade terminal (6.3 x 0.8 mm)	9

Symbols similar as in table A

5098 - H - A B C 0- **D** - E O = Color

Color	Configuration key
Black	A

Color	Configuration key
Grey	B

5098 - H - A B C 0- D - **E** O = Style

Style	Configuration key
flange with countersunk holes	1
flange with through holes	2

5098 - H - A B C 0- D - E **O** = Features

Features	Configuration key
not used	0
dead cover	1
holder for 1 fuse (text legible, when inlet on top)	2
holder for 1 fuse (text legible, when inlet on bottom)	3
holder for 1 or 2 fuses (text legible, when inlet on top)	4
holder for 1 or 2 fuses (text legible, when inlet on bottom)	5
voltage selector with 1 fuse	6
voltage selector with 2 fuses	7
thermal circuit breaker for rated current 4A	A
thermal circuit breaker for rated current 6A	B
thermal circuit breaker for rated current 8A	C
thermal circuit breaker for rated current 10A	D
thermal circuit breaker for rated current 15A	E
thermal circuit breaker for rated current 20A	F

All Variants

Type	Terminals L / N	Terminal Ground	Color	Style	Features	Config. Code	Order Number
protection class II	Blade terminal (6.3 x 0.8 mm)	without terminal	Black	flange with countersunk holes	-	5098-B-9900-A-1	<a href="#">6182.0027</a>
protection class I	solder terminal	solder terminal	Black	flange with countersunk holes	-	5098-X-1110-A-1	<a href="#">6182.0028</a>
protection class I	solder terminal	solder terminal	Grey	flange with countersunk holes	-	5098-X-1110-B-1	<a href="#">6182.0030</a>
protection class I	Blade terminal (6.3 x 0.8 mm)	Blade terminal (6.3 x 0.8 mm)	Black	flange with countersunk holes	-	5098-X-9990-A-1	<a href="#">6182.0031</a>
protection class I	Blade terminal (6.3 x 0.8 mm)	Blade terminal (6.3 x 0.8 mm)	Grey	flange with countersunk holes	-	5098-X-9990-B-1	<a href="#">6182.0032</a>

The listed variants should be available from stock. Other versions on request [www.schurter.com/contact](http://www.schurter.com/contact)

  Most Popular.

Availability for all products can be searched real-time: <https://www.schurter.com/en/Stock-Check/Stock-Check-SCHURTER>

**Packaging unit** 50 Pcs

## Mating Inlets/Plugs

## Category / Description

[Plug Overview complete](#)

IEC Plug E, Cord Connector (Rewireable), Straight, max. cable Diameter 8.5 mm	4732
IEC Plug E, Cord Connector (Rewireable), Straight, max. Cable Diameter 10 mm	4735
IEC Plug E, Cord Connector (Rewireable), Straight	9009
IEC Plug E, Cord Connector (Rewireable), Angled, max. Cable Diameter 8.5 mm	4733
IEC Plug E, Cord Connector (Rewireable), Angled, max. Cable Diameter 10 mm	4736
<a href="#">Plug further types to 5098</a>	...