

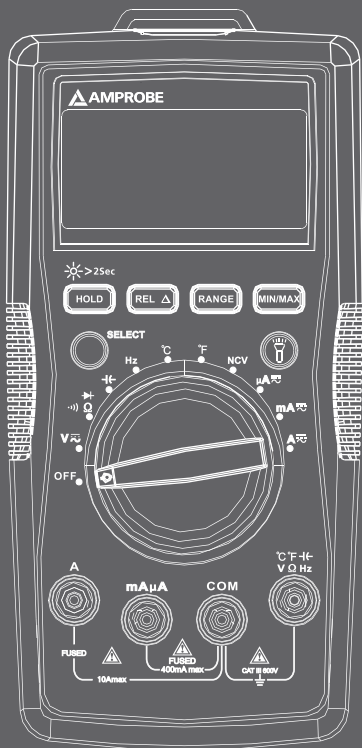

HARD AT WORK SINCE 1948.



AM-520
HVAC Multimeter

AM-530
True-rms Electrical
Contractor
Multimeter

AM-520-EUR
AM-530-EUR
Digital Multimeter

Users Manual



AM-520

HVAC Multimeter

AM-530

True-rms Electrical Contractor Multimeter

AM-520-EUR / AM-530-EUR

Digital Multimeter

Users Manual

English

Limited Warranty and Limitation of Liability

Your Amprobe product will be free from defects in material and workmanship for one year from the date of purchase, unless local laws require otherwise. This warranty does not cover fuses, disposable batteries or damage from accident, neglect, misuse, alteration, contamination, or abnormal conditions of operation or handling. Resellers are not authorized to extend any other warranty on Amprobe's behalf. To obtain service during the warranty period, return the product with proof of purchase to an authorized Amprobe Service Center or to an Amprobe dealer or distributor. See Repair Section for details. THIS WARRANTY IS YOUR ONLY REMEDY. ALL OTHER WARRANTIES - WHETHER EXPRESS, IMPLIED OR STATUTORY - INCLUDING IMPLIED WARRANTIES OF FITNESS FOR A PARTICULAR PURPOSE OR MERCHANTABILITY, ARE HEREBY DISCLAIMED. MANUFACTURER SHALL NOT BE LIABLE FOR ANY SPECIAL, INDIRECT, INCIDENTAL OR CONSEQUENTIAL DAMAGES OR LOSSES, ARISING FROM ANY CAUSE OR THEORY. Since some states or countries do not allow the exclusion or limitation of an implied warranty or of incidental or consequential damages, this limitation of liability may not apply to you.

Repair

All test tools returned for warranty or non-warranty repair or for calibration should be accompanied by the following: your name, company's name, address, telephone number, and proof of purchase. Additionally, please include a brief description of the problem or the service requested and include the test leads with the meter. Non-warranty repair or replacement charges should be remitted in the form of a check, a money order, credit card with expiration date, or a purchase order made payable to Amprobe®.

In-Warranty Repairs and Replacement – All Countries

Please read the warranty statement and check your battery before requesting repair. During the warranty period any defective test tool can be returned to your Amprobe® distributor for an exchange for the same or like product. Please check the "Where to Buy" section on www.amprobe.com for a list of distributors near you. Additionally, in the United States and Canada In-Warranty repair and replacement units can also be sent to a Amprobe® Service Center (see address below).

Non-Warranty Repairs and Replacement – US and Canada

Non-warranty repairs in the United States and Canada should be sent to an Amprobe® Service Center. Call Amprobe® or inquire at your point of purchase for current repair and replacement rates.

In USA:

Amprobe

Everett, WA 98203

Tel: 877-AMPROBE (267-7623)

In Canada:

Amprobe

Mississauga, ON L4Z 1X9

Tel: 905-890-7600

Non-Warranty Repairs and Replacement – Europe

European non-warranty units can be replaced by your Amprobe® distributor for a nominal charge. Please check the "Where to Buy" section on www.amprobe.com for a list of distributors near you.

European Correspondence Address*

Amprobe® Europe

Beha-Amprobe GmbH

In den Engematten 14

79286 Glotttetal, Germany

Tel.: +49 (0) 7684 8009 - 0

www.beha-amprobe.com

*(Correspondence only – no repair or replacement available from this address. European customers please contact your distributor.)

AM-520 HVAC Multimeter

AM-530 True-rms Electrical Contractor Multimeter

AM-520-EUR / AM-530-EUR Digital Multimeter

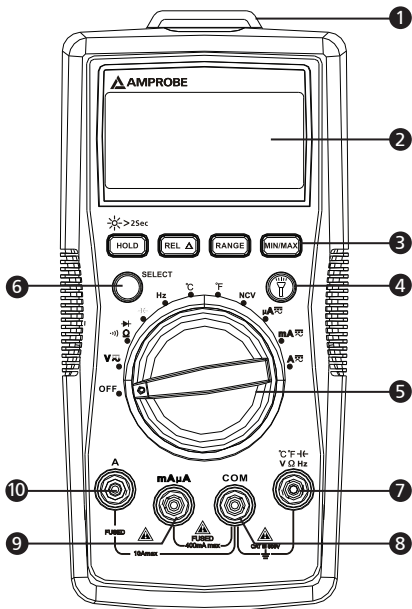

- ① Flash light
- ② LCD Display
- ③ Function Buttons
- ④ Flash light Button
- ⑤ Rotary Switch
- ⑥ SELECT Button
- ⑦ Input Terminal for voltage, diode, capacitance, Resistance, continuity and temperature measurement
- ⑧ COM (return) terminal for all measurements
- ⑨ Input Terminal for AC/DC mA/uA measurement
- ⑩ Input Terminal for AC/DC A measurement to 10A

Screen Display

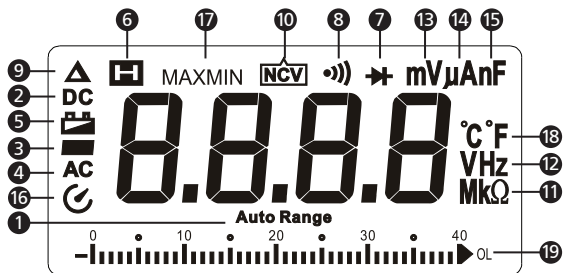













- 1 The Meter selects the range with best resolution
- 2 Direct Current
- 3 Negative reading
- 4 Alternate Current
- 5 Low battery indicator
- 6 Data hold
- 7 Diode test
- 8 Continuity test
- 9 Relative zero mode
- 10 Non-Contact Voltage
- 11 Measurement units for Resistance
- 12 Measurement units for Frequency
- 13 Measurement units for Voltage
- 14 Measurement units for Current
- 15 Measurement units for Capacitance
- 16 Auto Power Off
- 17 Maximum / minimum reading memory
- 18 Measurement unit for Temperature
- 19 Analog bar graph display

AM-520 HVAC Multimeter
AM-530 True-rms Electrical Contractor Multimeter
AM-520-EUR /AM-530-EUR Digital Multimeter

CONTENTS

SYMBOL	2
SAFETY INFORMATION	2
UNPACKING AND INSPECTION	3
FEATURES	4
MAKING MEASUREMENT	5
Measuring AC and DC Voltage.....	6
Measuring AC and DC Current.....	7
Measuring Resistance	8
Measuring Continuity	9
Measuring Diode.....	9
Measuring Capacitance	10
Measuring Frequency	10
Measuring Temperature °C /°F	11
Non-Contact Voltage Sensing	12
SPECIFICATION	13
MAINTENANCE	16
BATTERY AND FUSE REPLACEMENT	17

SYMBOLS

	Caution ! Risk of electric shock.
	Caution! Refer to the explanation in this Manual
	Alternating Current (AC)
	Direct Current (DC)
	The equipment is protected by double insulation or reinforced insulation
	Earth (Ground)
	Audible tone
	Battery
	Complies with European Directives
	Conforms to relevant Australian standards
	Canadian Standards Association (NRTL/C)
	Do not dispose of this product as unsorted municipal waste. Contact a qualified recycler.

SAFETY INFORMATION

The Meter complies with:

IEC/EN 61010-1 3rd Edition, UL61010-1 2nd Ed. and CAN/CSA C22.2 No. 61010.1-0.92 to Category III 600 Volts, Pollution degree 2

IEC/EN 61010-2-030

IEC/EN 61010-2-31 for test leads

EMC IEC/EN 61326-1

Measurement Category III (CAT III) is for measurements performed in the building installation. Examples are measurements on distribution boards, circuit-breakers, wiring, including cables, bus-bars, junction boxes, switches, socket-outlets in the fixed installation, and equipment for industrial use and some other equipment, for example, stationary motors with permanent connection to the fixed installation.

Measurement Category II (CAT II) is for measurements performed on circuit directly connected to low voltage installation. Examples are measurements on household appliances, portable tools and similar equipments.

 **Warning: Read Before Using**

- *To avoid possible electrical shock or personal injury, follow these instructions and use the Meter only as specified in this manual.*
- *Do not use the Meter or test leads if they appear damaged, or if the Meter is not operating properly. If in doubt, have the Meter serviced.*
- *Always use the proper function and range for measurements.*
- *Before rotating the function range selection switch, disconnect test probe from circuit under test.*
- *Verify the Meter's operation by measuring on a known voltage source.*
- *Do not apply more than the rated voltage, as marked on the Meter, between the test probe or between any test probe and earth ground.*
- *Use the Meter with caution for voltages above 30 Vac rms, 42 Vac peak, or 60 Vdc. These voltages pose electrical shock hazards.*
- *Disconnect circuit power and discharge all high-voltage capacitors before testing resistance.*
- *Do not use the Meter around explosive gas or vapor.*
- *When using the test leads, keep your fingers behind the finger guards.*
- *Remove test leads from the Meter before opening the Meter case or battery door.*

UNPACKING AND INSPECTION

Your shipping carton should include:

- 1 AM-520 or AM-530 or AM-520-EUR or AM-530-EUR
- 1 Pair of test leads
- 1 Temperature probe
- 1 Velcro strap
- 1 9V (6F22) battery (installed)
- 1 Users manual
- 1 Carrying case

If any of the items are damaged or missing, return the complete package to the place of purchase for an exchange.

FEATURES

AM-520 / AM-520-EUR is designed for HVAC applications with key functions such as temperature, micro amps used for flame sensor troubleshooting, as well as and capacitance to check the motor startup capacitors. The AM-520 / AM-520-EUR measures a complete range of electrical parameters and features a built in flashlight, a "third hand" probe holder and VoltTect non-contact voltage detection. Safety rated to CAT III 600V.

AM-530 / AM-530-EUR is the fully-featured multimeter of choice for the professional electrical contractor. Measure and verify presence of voltage in order to connect equipment or to perform repairs, run new wiring, check continuity of electrical connections, identify blown fuses, troubleshoot motors or check transformers. The AM-530 / AM-530-EUR features Truerms sensing to accurately measure voltage on systems affected by harmonics, a built in flashlight to detect wire colors in the dark, a "third hand" probe holder and non-contact voltage detection. Safety rated to CAT III 600V.

- Measurements: Voltage up to 600VAC and 600VDC, AC/DC current, Resistance, Frequency, Capacitance, Temperature.
- Frequency, Capacitance, Duty Cycle for troubleshooting applications
- Special Functions:
 - Non-contact Voltage Detection
 - Audible continuity
 - Diode Test
- Backlit LCD display with analog bar graph
- Events:
 - Data hold
 - MAX / MIN Memory
 - Relative zero mode
- Built in work light (flashlight)
- Built in test leads storage and "third hand holder"
- Auto and Manual ranging
- Auto power off
- Low battery warning
- Velcro strap to hang a meter
- Safety: CAT III 600V

MAKING MEASUREMENT





1. Use the proper function and range for measurements.
2. To avoid possible electrical shock, personal injury or damages to the Meter, disconnect circuit power and discharge all high-voltage capacitors before testing resistance and diode.
3. Connecting test leads:
 - Connect the common (COM) test lead to the circuit before connecting the live lead;
 - After measurement, remove live lead before removing the common (COM) test lead from the circuit
4. Symbol "OL" is displayed on LCD when the measurement is out of range.

Rotary Switch Positions

Switch Position	Measurement Function
$V \overline{\sim}$	AC or DC voltage measurement (use SELECT button for switching to AC or DC).
Ω	Resistance measurement
$\rightarrow \dashv$	Voltage measurement of diode PN junction
$\bullet \))$	Continuity measurement
$\dashv \vdash$	Capacitance measurement
Hz	Frequency measurement
$^{\circ}C \ ^{\circ}F$	Temperature measurement
NCV	Non-contact voltage
$\mu A \overline{\sim}$ mA $\overline{\sim}$ A $\overline{\sim}$	AC or DC current measurement (use SELECT button for switching to AC or DC).

Function Buttons

Button	Measurement Function
SELECT	Switching AC or DC. Press the yellow SELECT button to select alternate measurement functions on the rotary switch.
HOLD /  > 2Sec	Display freezes present reading / press 2 sec to turn on LCD backlight.

REL Δ	Relative zero mode
RANGE	Manual or Auto range switching. The default setting is Auto ranging, press to switch to manual ranging (selectable resolutions). Press for 2 sec to return to auto ranging.
MAX/MIN	Maximum / minimum reading memory.
	Flash light

Press  to enable the function when at relevant rotary switch function.

Auto Power OFF

Auto power off: approx. 15 minutes.

When the Meter is in auto power off mode, press any button to resume normal operation.

Measuring AC and DC Voltage

Press SELECT button to select AC/DC voltage measurement function.

 To avoid personal injury or damage to the Meter, do not apply voltage higher than 600Vac and 600Vdc.

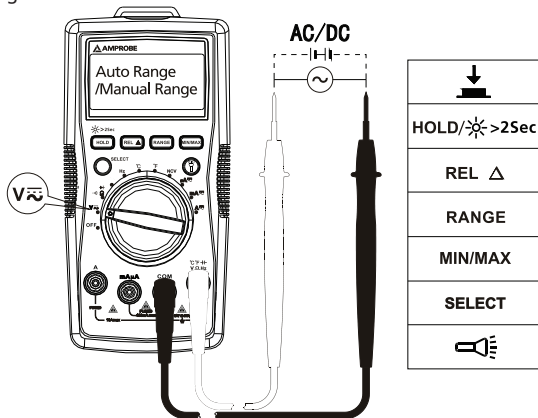

Measuring AC and DC Current

Press SELECT button to select AC or DC current measurement function.



To avoid personal injury or damage to the Meter:

1. Do not attempt to make an in-circuit current measurement when the open-circuit potential to earth ground exceeding AC 600V or DC 600V
2. Switch to proper function and range for your measurement.
3. Do not place the test probe in parallel with a circuit when the test leads are connected to the current terminals.
4. Connect the test leads to the correct input A/mA μ A current terminal and to the circuit before powering the circuit under test.
5. For current range from 8-10A, do not measure current for more than 20 minutes. Wait for 10 minutes before taking another measurement
6. After measurement, switching OFF the circuit's power before removing test leads from the circuit.

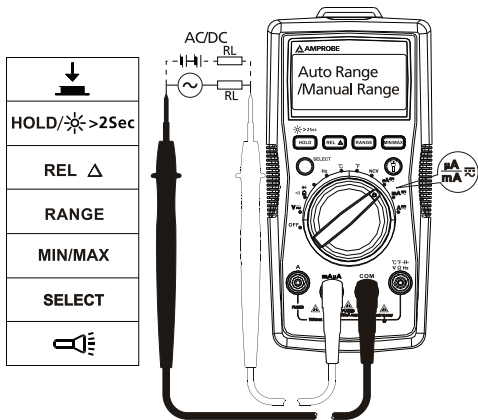

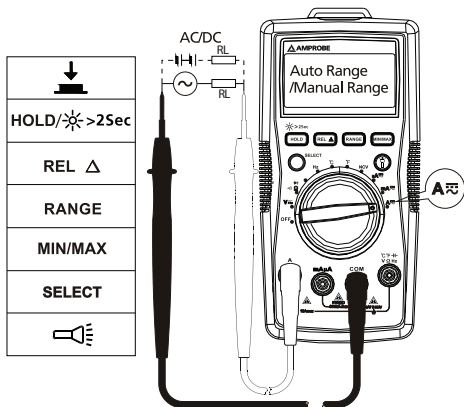

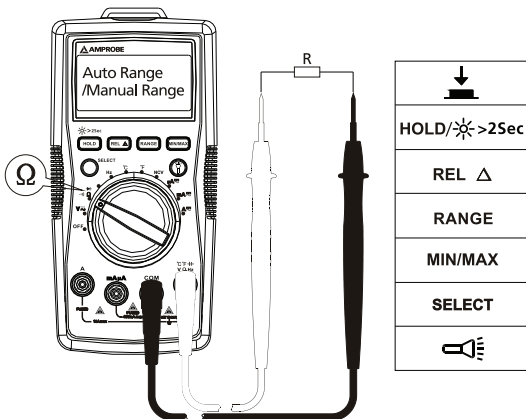

Measuring Resistance

Disconnect circuit power and discharge all high-voltage capacitors before testing resistance.





Note: On a higher resistance measurement (>1MΩ), the measurement may take a few seconds to get stable reading.
Over range or open circuit indication: OL

Measuring Continuity

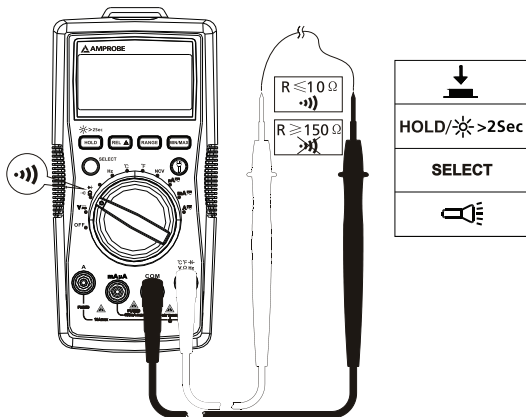
  Disconnect circuit power and discharge all high-voltage capacitors before testing continuity.



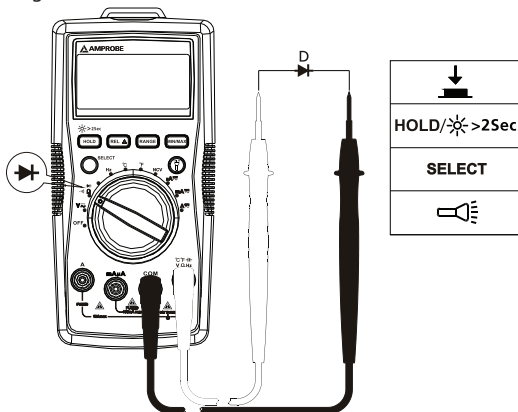

Measuring Diode

  Disconnect circuit power and discharge all high-voltage capacitors before testing diode.



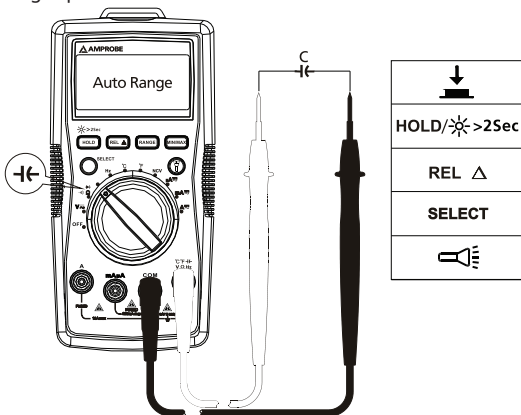

Measuring Capacitance

  Disconnect circuit power and discharge all high-voltage capacitors before testing capacitance.



Measuring Frequency

  To avoid personal injury or damage to the Meter, do not apply voltage higher than 600V.

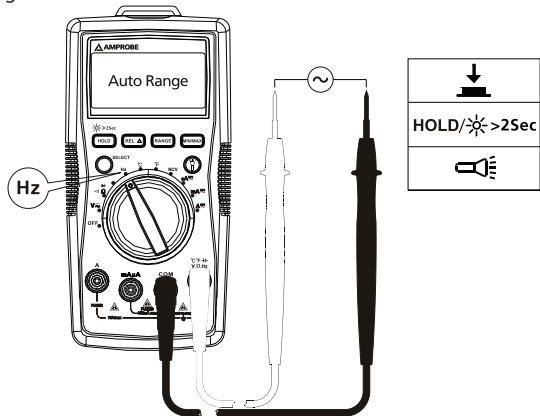

Measuring Temperature °C / °F



1. To avoid personal injury or damage to the Meter, do not apply the temperature probe to any live conductive parts.
2. Temperature sensor K type (nickel-chromium/nichrosi) thermocouple is suitable for temperature measurement below 230°C (446°F).

Measurement steps:

Step 1: Turn the rotary switch to °C or °F position. The display will show "OL".

Step 2: Connect the temperature probe (K type) to the Meter and to the surface to be measured.

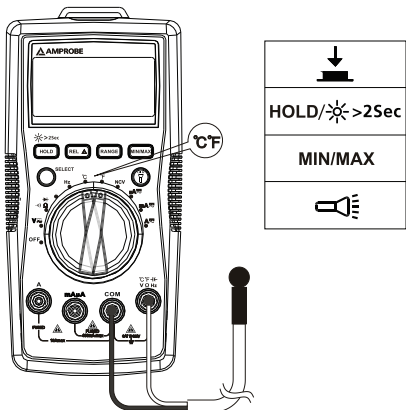

Non-Contact Voltage Sensing

1. To avoid personal injury or damage to the Meter, do not test on un-insulated high voltage wires.
2. Buzzer will sound and screen will display "OL" when sensing AC voltage between 90V and 600V
3. Do not test on hazardous live wires higher than AC 600V
4. Before and after hazardous voltage measurements, test the Meter by approaching to a known source such as a line AC voltage or outlet to determine proper operation. See below figure.

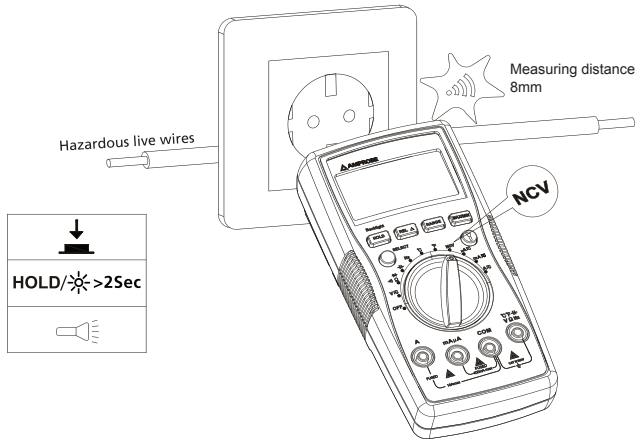

Buzzer will sound when the detected voltage is $\geq 90V$, and the buzzer will be on. The distances between the wire and the meter should be $\leq 8mm$.



At NCV mode, LCD will display OL. No test lead connection are required for NCV measurement.

SPECIFICATION

Ambient temperature: 73.4°F ±9 (23°C ±5°C); **Relative temperature:** ≤75%
Accuracy: ±(% of reading + digits)

Maximum voltage between input terminal and earth ground: AC 600Vrms or DC 600V

 **Fuse for mA μA input:** F1 fuse, 0.5A H 1000V fast-fuse, (6.3×32)mm

 **Fuse for 10A input:** F2 fuse, 11A H 1000V fast-fuse, (10×38)mm

Maximum display: Digital 3999 counts, updates 3/sec. Frequency: 9999 counts.

Analog pointer display: 41 segments, updates 30 times/sec.

Over-range indication: OL

Range: Automatic and Manual

Altitude: Operating 2000m

Operating temperature: 0°C ~ +40°C (32°F ~ 104°F)

Relative humidity: 0°C ~ +30°C (32°F ~ 86°F) ≤75%; +30°C ~ +40°C (86°F ~ 104°F) ≤50%

Storage temperature: -10°C ~ +50°C (14°F ~ 122°F)

Electromagnetic compatibility: In an RF field of 1V/m = Specified accuracy 5%

Battery: 9V, 6F22, NEDA1604 or equivalent

Low battery indication: 

Dimensions (L x W x H): 182 mm x 90 mm x 45 mm (7.2 in x 3.5 in x 1.8 in)

Weight: Approx. 354g (0.78lb) with batteries installed

1. DC Voltage Measurement

Range	Resolution	Accuracy
400.0mV	0.1mV	± (0.8%+3LSD)
4.000V	1mV	± (0.8%+1LSD)
40.00V	10mV	
400.0V	100mV	
600V	1V	±(1.0%+3LSD)

Input impedance: About 10M ;

(Input impedance is ≤3GΩ except DC 400mV range)

Overload protection: ±600V

2. AC Voltage Measurement

Range	Resolution	Accuracy
400.0mV	0.1mV	$\pm(1.2\%+3\text{LSD})$
4.000V	1mV	$\pm(1.0\%+3\text{LSD})$
40.00V	10mV	
400.0V	100mV	
600V	1V	$\pm(1.2\%+3\text{LSD})$

Note: Manual range only for 400.0mV range.

Input impedance: Around $10\text{M}\Omega$

Frequency response: 45Hz ~ 400Hz

AM-520 / AM-520-EUR : Average sensing, rms indication.

AM-530 / AM-530-EUR: True RMS.

Overload protection: 600Vrms

3. Resistance Measurement

Range	Resolution	Accuracy
400.0 Ω	0.1 Ω	$\pm(1.2\%+2\text{LSD})$
4.000k Ω	1 Ω	$\pm(1.0\%+2\text{LSD})$
40.00k Ω	10 Ω	
400.0k Ω	100 Ω	
4.000M Ω	1k Ω	$\pm(1.2\%+2\text{LSD})$
40.00M Ω	10k Ω	$\pm(1.5\%+5\text{LSD})$

400 Ω range: Measured value = (Measured display value – Short-circuiting value of probe)

Open circuit voltage: Around 0.5V

Overload protection: 600Vrms

4. $\bullet\))$: Circuit ON/OFF \rightarrow : Diode measurement

Range	Resolution	Accuracy
$\bullet\))$	0.1 Ω	Open circuit voltage is around 0.5V. Resistance >150 Ω , buzzer will not sound. Resistance \leq 10 Ω , buzzer will sound.

	1mV	Display range is 0V to 2.0V. Normal voltage is around 0.5V to 0.8V for silicon PN junction.
--	-----	---

Overload protection: 600V

5. Capacitance Measurement

Range	Resolution	Accuracy
40.00nF	10pF	$\pm(3\%+10\text{LSD})$ under REL status
400.0nF	100pF	$\pm(3\%+5\text{LSD})$ under REL status
4.000 μ F	1nF	
40.00 μ F	10nF	$\pm(3\%+5\text{LSD})$
400.0 μ F	100nF	$\pm(4\%+5\text{LSD})$
4000 μ F	1 μ F	For reference only

Overload protection: 600V

6. Frequency Measurement

Range	Resolution	Accuracy
10Hz~10MHz	0.01Hz~0.01MHz	$\pm(0.1\%+4\text{LSD})$

Overload protection: 600Vrms

7. DC Current Measurement

Range		Resolution	Accuracy
μ A	400.0 μ A	0.1 μ A	$\pm(1.0\%+2\text{LSD})$
	4000 μ A	1 μ A	
mA	40.00mA	10 μ A	
	400.0mA	0.1mA	
A	4.000A	1mA	$\pm(1.2\%+3\text{LSD})$
	10.00A	10mA	

Overload protection:

mA / μ A range:F1 fuse, 0.5A H 1000V fast-fuse, (Φ 6.3 \times 32)mm

10 A range:F2 fuse, 11A H 1000V fast-fuse, (Φ 10 \times 38)mm

8. AC Current Measurement

Range		Resolution	Accuracy
μA	400.0μA	0.1μA	±(1.2%+3LSD)
	4000μA	1μA	
mA	40.00mA	10μA	
	400.0mA	0.1mA	
A	4.000A	1mA	±(1.5%+3LSD)
	10.00A	10mA	

Frequency response: 45Hz ~ 400Hz

AM-520 / AM-520-EUR : Average sensing, rms indication.

AM-530 / AM-530-EUR: True RMS.

Overload protection:

mA /μA range:F1 fuse, 0.5A H 1000V fast-fuse, (Φ6.3×32)mm

10 A range:F2 fuse, 11A H 1000V fast-fuse, (Φ10×38)mm

9. Temperature Measurement

Range	Resolution	Accuracy
-40 – 0°C	0.1°C @ < 400°C 1°C @ ≥ 400°C	±(10%+4 LSD)
>0 – 100°C		±(1.2%+3 LSD)
>100 – 1000°C		±(2.5%+2 LSD)
-40 – 32°F	0.1°F @ < 752°F 1°F @ ≥ 752°F	±(20%+6 LSD)
>32 – 212°F		±(1.8%+6 LSD)
>212 – 1832°F		±(2.5%+4 LSD)

Overload protection: 600V

K type (nickel-chromium/nichrosi) thermocouple must be used for temperature measurement.

MAINTENANCE AND REPAIR

If the Meter fails to operate, check battery, test leads, etc., and replace as necessary.

Double check the followings:

1. Replace the fuse or battery if the meter does not work.
2. Review the operating instructions for possible mistakes in operating procedure.

Quick check on 0.5A FUSE:

Step 1: Turn the rotary switch to Ω function.

Step 2: short-circuit ∇ /V/ Ω /Hz terminal and mA/ μ A terminal.

Resistance reading $\leq 1M\Omega$: the fuse is OK

Resistance reading "OL": the fuse is open. Replace the fuse as specified.

Quick check on 10A FUSE:

Step 1: Turn the rotary switch to Ω function.

Step 2: short-circuit ∇ /V/ Ω /Hz terminal and A terminal.

Resistance reading $\leq 0.5\Omega$: the fuse is OK.

Resistance reading "OL": the fuse is open. Replace the fuse as specified.

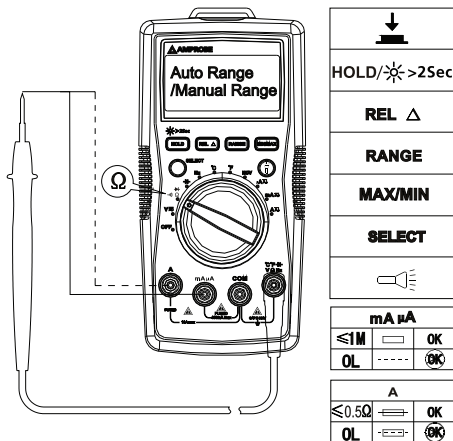

Except for the replacement of the battery, repair of the meter should be performed only by a Factory Authorized Service Center or by other qualified instrument service personnel.

The front panel and case can be cleaned with a mild solution of detergent and water. Apply sparingly with a soft cloth and allow to dry completely before using. Do not use aromatic hydrocarbons, Gasoline or chlorinated solvents for cleaning.

BATTERY AND FUSE REPLACEMENT



WARNING

To avoid shock, injury, or damage to the Meter:

Disconnect test leads before opening case.

Use ONLY fuses with the amperage, interrupt, voltage, and speed ratings specified.

Replacing BATTERY follow below steps:

1. Disconnect the test lead probe from measuring circuit.
2. Turn the Meter to OFF position.
3. Remove the screws from the battery cover and open the battery cover
4. Remove the batteries and replace with one 9V (6F22) or equivalent. The battery cover provides the correct polarity fitting construction design. Install the battery in the battery cover.
5. Put the battery cover back and re-fasten the screw.

Battery: 9V (6F22) Battery or equivalent

Replacing FUSE follow below steps:

1. Disconnect the test lead probe from measuring circuit.
2. Turn the Meter to OFF position.
3. Remove the screws from the enclosure and open the enclosure.
4. Remove the broken fuse and replace with new specified fuse.
5. Put the enclosure back and re-fasten the screw.

Fuse ratings:

mA / μ A input terminal: F1 fuse, 0.5A H 1000V fast-fuse, (Φ 6.3 \times 32)mm

10 A input terminal: F2 fuse, 11A H 1000V fast-fuse, (Φ 10 \times 38)mm

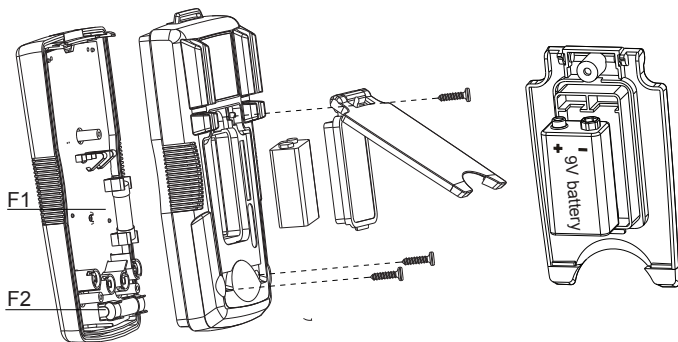

Visit www.Amprobe.com for

- **Catalog**
- **Application notes**
- **Product specifications**
- **User manuals**

Amprobe®

www.Amprobe.com

info@amprobe.com

Everett, WA 98203

Tel: 877-AMPROBE (267-7623)

Amprobe® Europe

Beha-Amprobe

In den Engematten 14

79286 Glottertal, Germany

Tel.: +49 (0) 7684 8009 - 0



Please
Recycle