

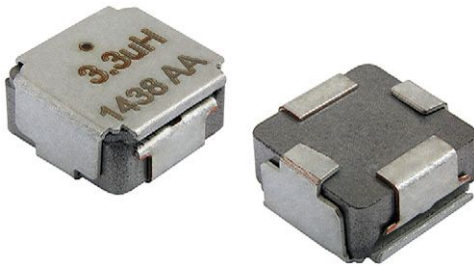

IHLP® Automotive Inductors, High Temperature (155 °C) Series



FEATURES

- High temperature, up to 155 °C
- Integrated E-Shield for maximum EMI reduction ⁽¹⁾
- Excellent DC/DC energy storage up to 1 MHz to 2 MHz. Filter inductor applications up the SRF (see Standard Electrical Specifications table)
- Integrated e-field shield eliminates need for separate shielding
- 20 dB e-field reduction at 1 cm
 - Measured vertically from top center of device
- Lowest DCR/μH, in this package size
- Handles high transient current spikes without saturation
- Coplanarity of the 4 terminals ≤ 100 μm
- AEC-Q200 qualified
- **Patent pending**
- Material categorization: for definitions of compliance please see www.vishay.com/doc?99912

DESIGN SUPPORT TOOLS click logo to get started



STANDARD ELECTRICAL SPECIFICATIONS					
L ₀ INDUCTANCE ± 20 % AT 100 kHz, 0.25 V, 0 A (μH)	DCR TYP. 25 °C (mΩ)	DCR MAX. 25 °C (mΩ)	HEAT RATING CURRENT DC TYP. (A) ⁽¹⁾	SATURATION CURRENT DC TYP. (A) ⁽²⁾	SRF TYP. (MHz)
0.47	3.87	4.14	20.0	14.0	82.4
0.68	5.38	5.76	16.5	17.0	56.1
0.82	6.75	7.22	13.8	16.8	68.6
1.0	7.90	8.45	12.0	13.0	53.2
1.5	12.3	13.2	10.6	11.6	45.9
2.2	17.1	18.30	8.1	10.8	31.2
3.3	26.5	28.40	6.8	8.3	28.6
4.7	35.9	38.40	5.6	5.6	25.5
5.6	42.6	45.60	5.3	4.8	22.8
6.8	53.8	57.60	4.4	4.4	19.6
10	71.9	76.90	4.0	2.9	14.0
15	118.0	127.00	2.9	2.8	10.4
22	163.0	174.00	2.8	2.2	8.3

Notes

- All test data is referenced to 25 °C ambient
- Operating temperature range -55 °C to +155 °C
- The part temperature (ambient + temp. rise) should not exceed 155 °C under worst case operating conditions. Circuit design, component placement, PWB trace size and thickness, airflow and other cooling provisions all affect the part temperature. Part temperature should be verified in the end application
- Rated operating voltage (across inductor) = 50 V
- ⁽¹⁾ DC current (A) that will cause an approximate ΔT of 40 °C
- ⁽²⁾ DC current (A) that will cause L₀ to drop approximately 20 %

Note

⁽¹⁾ Maximum E-field reduction is realized with the IHLE shield is connected to ground

APPLICATIONS

- Engine and transmission control units
- Diesel injection drivers
- DC/DC converters for entertainment/navigation systems
- Noise suppression for motors
 - Windshield wipers
 - Power seats
 - Power mirrors
 - Heating and ventilation blower
 - HID lighting
- LED drivers

DESCRIPTION					
MODEL	INDUCTANCE VALUE	INDUCTANCE TOLERANCE	PACKAGE CODE	JEDEC® LEAD (Pb)-FREE STANDARD	
IHLE-2525CD-5A	15 μH	± 20 %	ER	e3	

GLOBAL PART NUMBER																	
I	H	L	E	2	5	2	5	C	D	E	R	1	5	0	M	5	A
PRODUCT FAMILY				SIZE				PACKAGE CODE		INDUCTANCE VALUE			TOL.	SERIES			

DIMENSIONS in inches [millimeters]

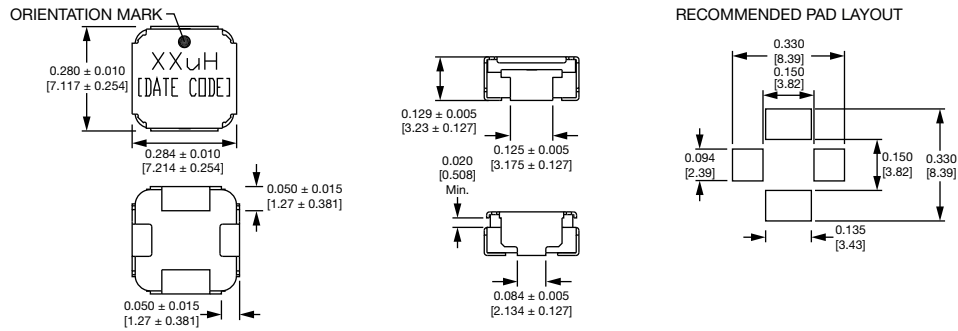

Notes

- Dot indicate the coil pin
- Coplanarity of 4 terminals: 0.004" [0.10]

PERFORMANCE GRAPHS

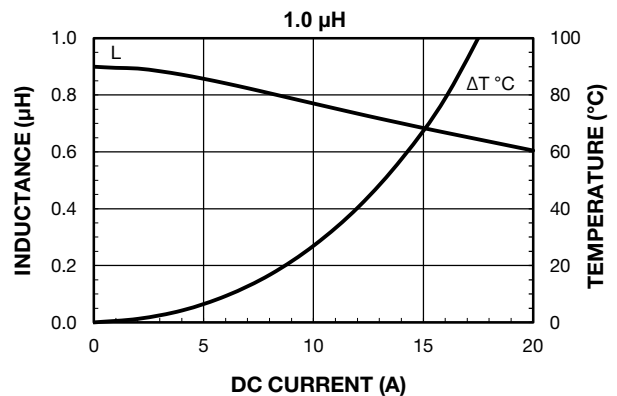
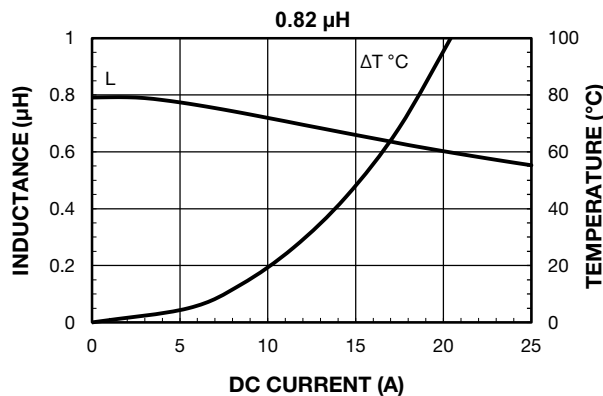
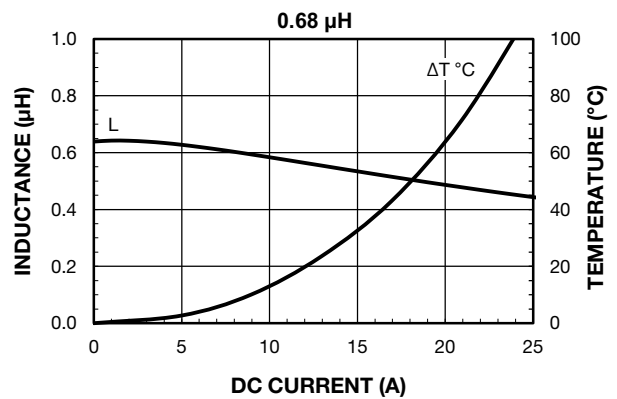
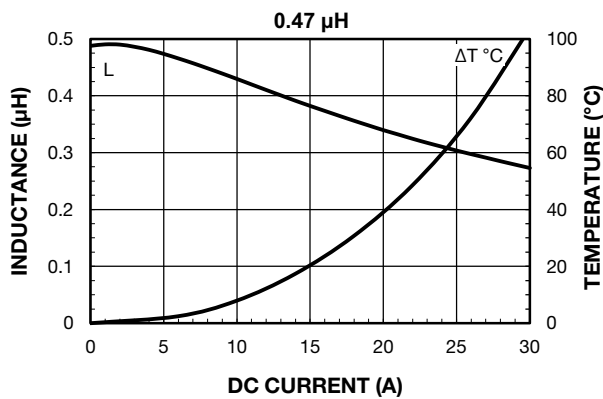



PERFORMANCE GRAPHS

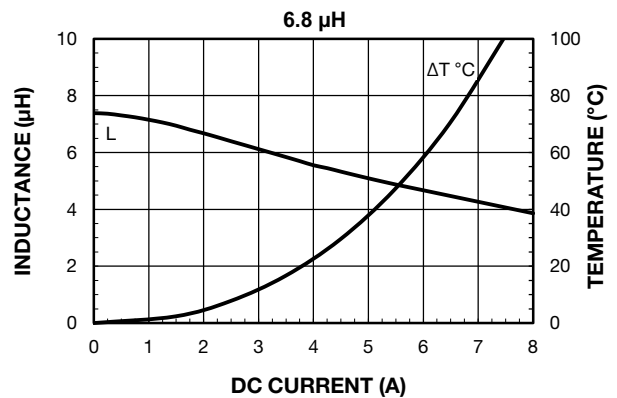
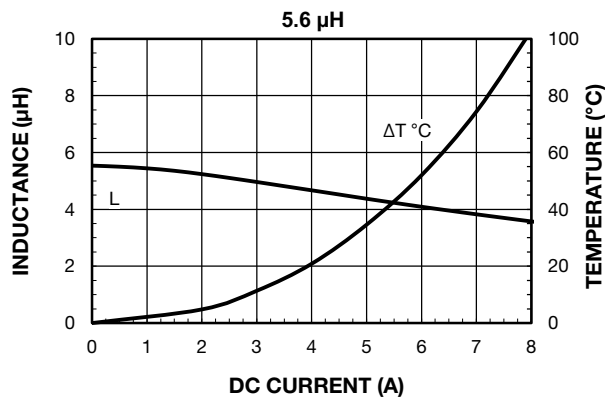
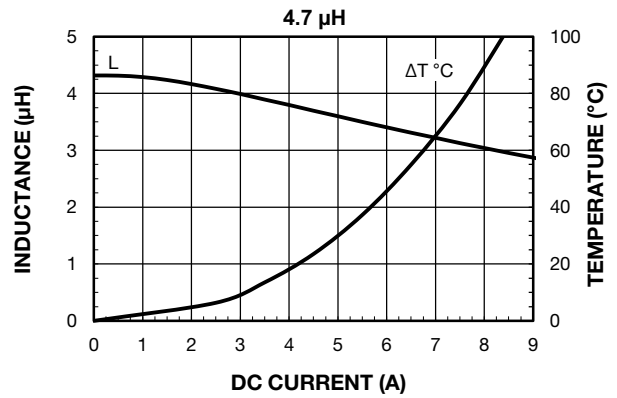
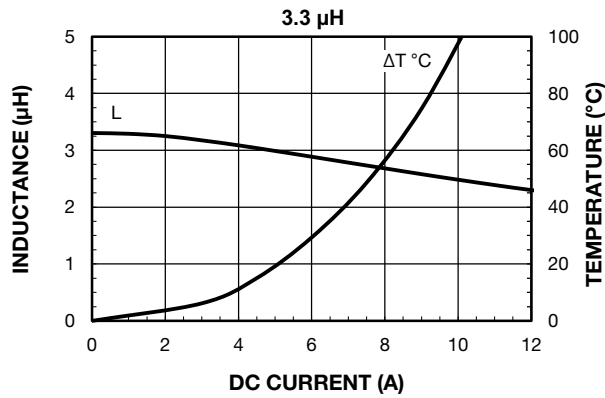
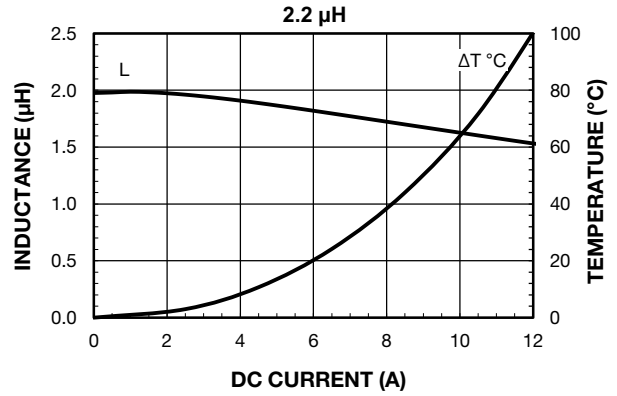
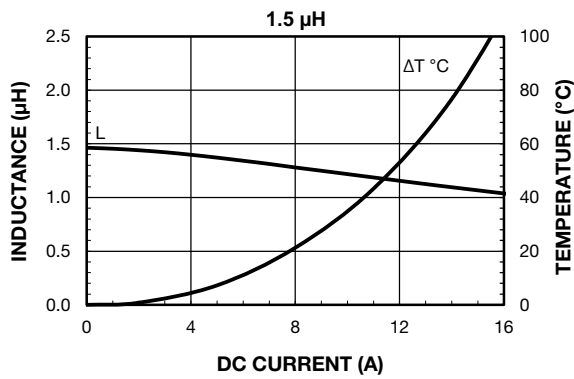



PERFORMANCE GRAPHS

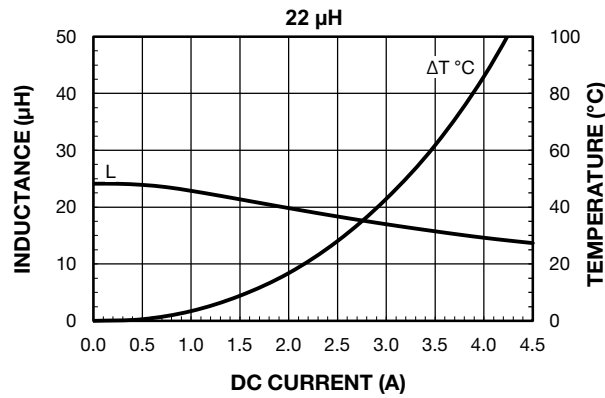
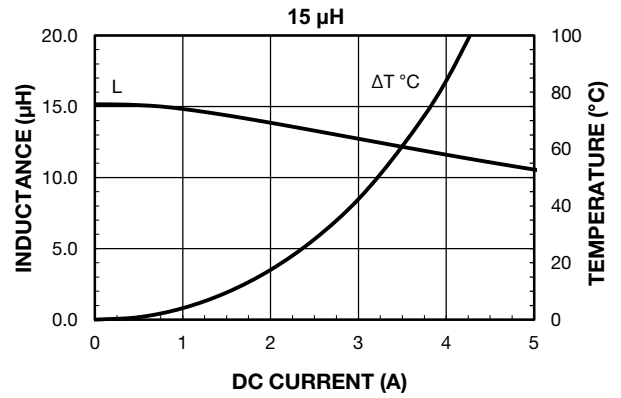
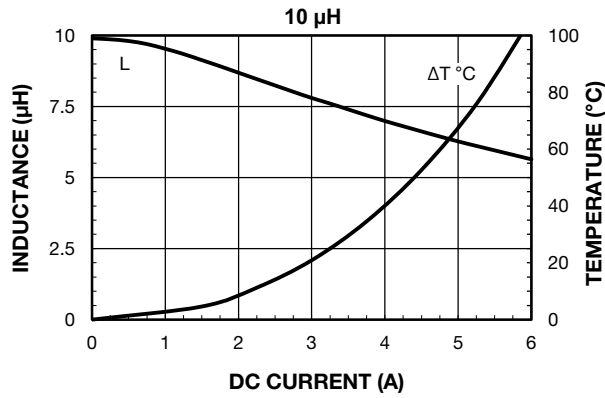



PERFORMANCE GRAPHS: INDUCTANCE AND Q VS. FREQUENCY

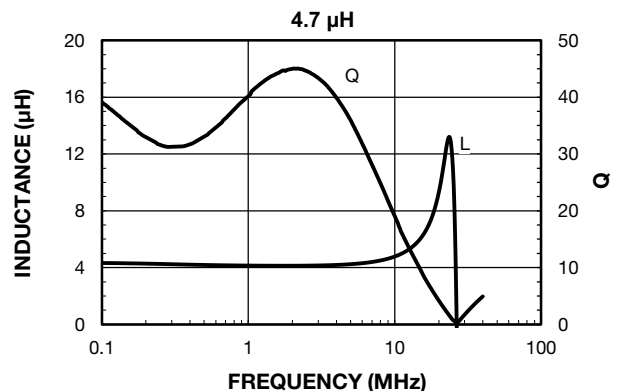
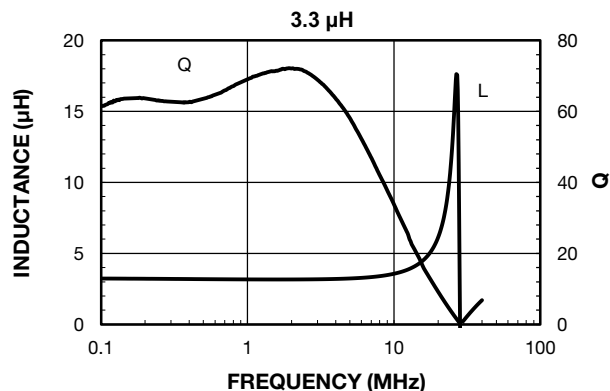
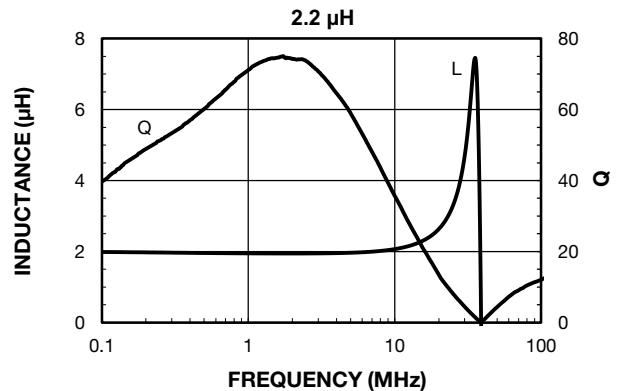
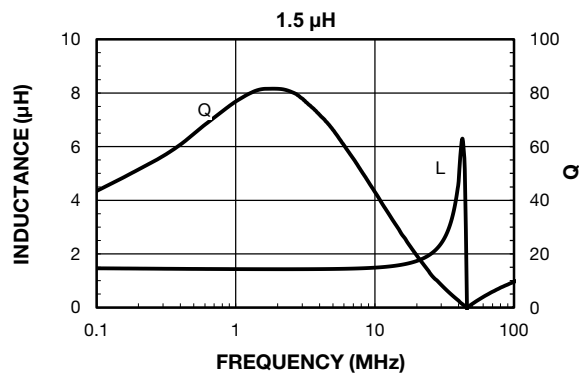
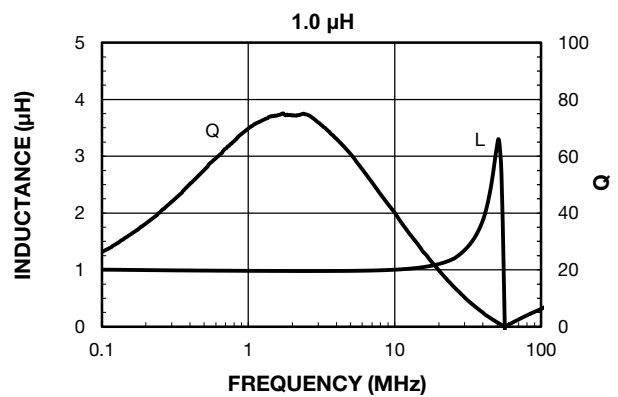
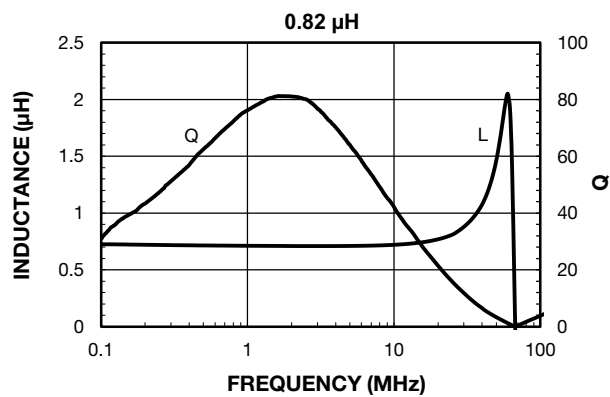
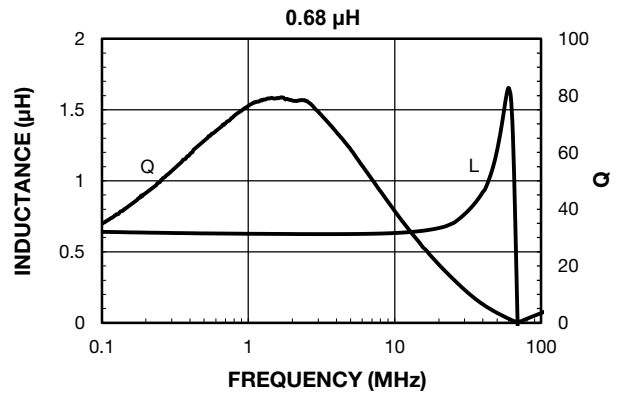
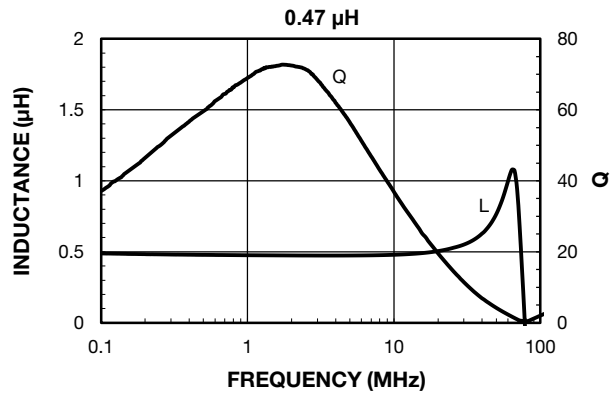

PERFORMANCE GRAPHS: INDUCTANCE AND Q VS. FREQUENCY

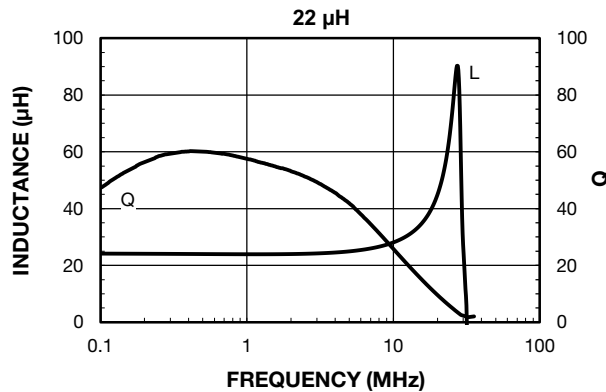
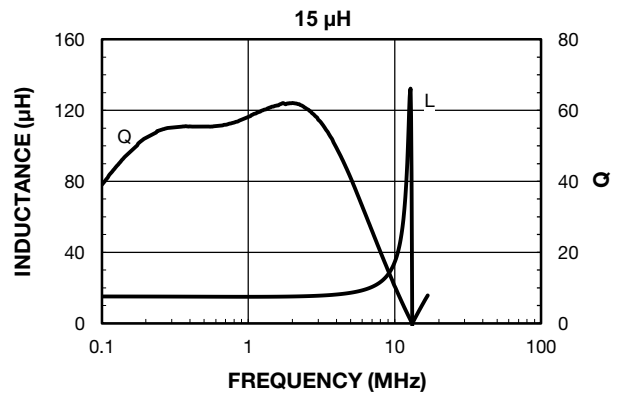
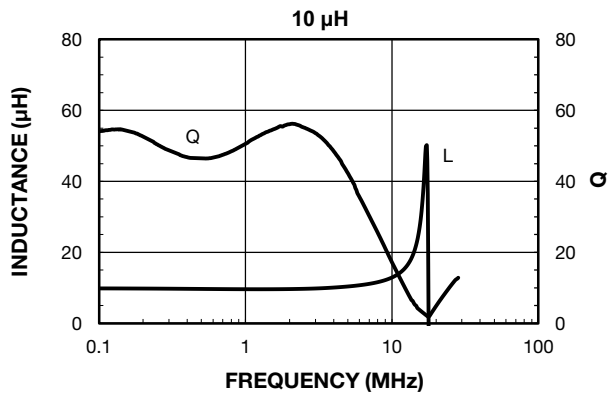
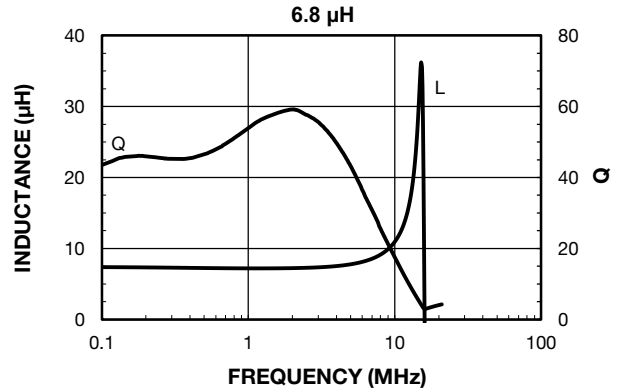
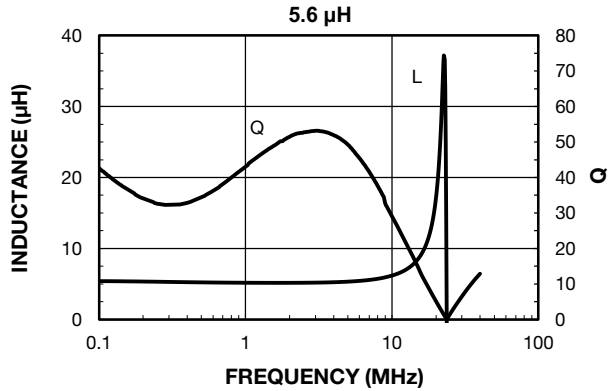



Disclaimer

ALL PRODUCT, PRODUCT SPECIFICATIONS AND DATA ARE SUBJECT TO CHANGE WITHOUT NOTICE TO IMPROVE RELIABILITY, FUNCTION OR DESIGN OR OTHERWISE.

Vishay Intertechnology, Inc., its affiliates, agents, and employees, and all persons acting on its or their behalf (collectively, "Vishay"), disclaim any and all liability for any errors, inaccuracies or incompleteness contained in any datasheet or in any other disclosure relating to any product.

Vishay makes no warranty, representation or guarantee regarding the suitability of the products for any particular purpose or the continuing production of any product. To the maximum extent permitted by applicable law, Vishay disclaims (i) any and all liability arising out of the application or use of any product, (ii) any and all liability, including without limitation special, consequential or incidental damages, and (iii) any and all implied warranties, including warranties of fitness for particular purpose, non-infringement and merchantability.

Statements regarding the suitability of products for certain types of applications are based on Vishay's knowledge of typical requirements that are often placed on Vishay products in generic applications. Such statements are not binding statements about the suitability of products for a particular application. It is the customer's responsibility to validate that a particular product with the properties described in the product specification is suitable for use in a particular application. Parameters provided in datasheets and / or specifications may vary in different applications and performance may vary over time. All operating parameters, including typical parameters, must be validated for each customer application by the customer's technical experts. Product specifications do not expand or otherwise modify Vishay's terms and conditions of purchase, including but not limited to the warranty expressed therein.

Except as expressly indicated in writing, Vishay products are not designed for use in medical, life-saving, or life-sustaining applications or for any other application in which the failure of the Vishay product could result in personal injury or death. Customers using or selling Vishay products not expressly indicated for use in such applications do so at their own risk. Please contact authorized Vishay personnel to obtain written terms and conditions regarding products designed for such applications.

No license, express or implied, by estoppel or otherwise, to any intellectual property rights is granted by this document or by any conduct of Vishay. Product names and markings noted herein may be trademarks of their respective owners.